

# Akbas

Korkuluk & Metal Ürünleri



**Top Quality !**

*produced by "AKBAS"*



 **Kaufen auch Sie direkt von der Quelle !!**

 **Achetez directement de la source !!**

 **Buy directly from the source !!**

 **Comprì anche lei direttamente dalla fonte !!**

 **Ürünleri kaynağından temin ediniz !!**

**Programm 2010**  
Programme / Program / Programma / Program

## Liebe Kunden,

seit 1990 ist Kundenzufriedenheit unser oberstes Ziel. Daher setzen wir immer höhere Maßstäbe, um Ihnen hochqualitative Produkte aus Edelstahl, Kunstschmiedeeisen, Messing, Alu und Zamak mit einem exzellenten Preis-Leistungsverhältnis anzubieten.

**Kaufen auch Sie direkt von der Quelle.**

**AKBAS**

*... von Profis für Profis !*

## Inhalt

### Edelstahl

Rohrabschluss 4-5  
Kugel 6  
Zierteile 6  
Abdeckrosetten 7  
Designstäbe 8-11  
Querstabhalter 12-13  
Klemmbefestigungen 14-17  
Handlaufzubehör 20-22  
Wandbefestigung 23  
Stanzteile 24-25  
Rohrbögen 26-27  
Steckfittings 28-29  
Schlossgehäuse 30-32  
Scharniere 31  
Türdrücker 33-36  
Seilsystem und Zubehör 37-41

### Zink

Klemmbefestigungen 16-17

### Messing

Rohrabschlussstopfen 42  
Kugel 42  
Abdeckrosetten 43  
Handlaufzubehör 43  
Zierteile 43

### Schmiedeeisen

Ankerplatten 44-45  
Rohrabschlussstopfen 46  
Abdeckrosetten 46  
Kugel 47  
Schnörkel 48-53  
Designstäbe 54  
U- Bunde 55  
Zierstäbe 56-63  
Schmiedestäbe 64-65  
Anfangsstäbe 68  
Stangenmaterial 69  
Handlaufzubehör 70  
Korbstäbe 71-72  
Zierspitzen & Lanzenstäbe 73

Rosetten 74  
Schmiedestücke & Zierteile 74  
Ringen 75  
Ornamente - Zierblätter 75-77  
Tür- und Torbogen 78  
Schmiedeeisen- Drückergarnituren 79  
Schmiedeeisen- Schlossblenden 79  
Torbänder 80  
Schiebetorrollen 81-82  
Türstopper 83  
Schloss & Zubehör 84-87

### Aluminium

Aluminium - Beschläge 88-89

### Hilfs- und Befestigungsmittel

90-98

## Chères nos clients,

Depuis 1990, la satisfaction de client est notre principe fondamental. Lors que nous vous présentons toujours les produits d'acier inoxydable, le fer forgé, le laiton, l'aluminium et le mat de zinc à la plus haute qualité avec ce principe, nous continuons nos travaux en déterminant nous-mêmes les cibles nouvelles à la haute échelle.

**Vous assurez le produit de sa source.**

**AKBAS**

*.... Aux professionnels de professionnel !*

## Sommaire

### Inox

Embouts de fermeture 4-5  
Sphères 6  
Accessoires 6  
Rosaces 7  
Barreaux design 8-11  
Supports transversaux 12-13  
Pincés de vitre 14-17  
Accessoires de main-courantes 20-22  
Articles de fixation 23  
Platines 24-25  
Raccords 26-29  
Boîtiers de serrure 30-32  
Gonds 31  
Poignée de porte 33-36  
Cordages acier et équipements 37-41

### Zinc

Pincés de vitre 16-17

### Laiton

Embouts de fermeture 42  
Sphères 42  
Rosaces 43  
Accessoires de main-courantes 43  
Accessoires 43

### Fer forgé

Platines de fixation 44-45  
Embouts de fermeture 46  
Rosaces 46  
Sphères 47  
Volutes 48-53  
Barreaux design 54  
Colliers en U 55  
Balustres 56-63  
Balustres forgées 64-65  
Barreaux de départ 68  
Barreaux divers 69  
Accessoires de main-courantes 70  
Barreau galbé 71-72  
Fers de lance 73

Rosettes forgées 74  
Accessoires en fer forgé 74  
Anneaux 75  
Ornements - Feuilles 75-77  
Arcs pour portes et portails 78  
Poignées en fer forgé 79  
Plaques de serrure en fer forgé 79  
Gonds 80  
Galets 81-82  
Butée pour portail coulissant 83  
Serrures & Accessoires 84-87

### Aluminium

Poignées en aluminium 88-89

### Autres articles de montage

90-98

**Stainless Steel**

End caps 4-5  
Spheres 6  
Accessories 6  
Cover plates 7  
Design bars 8-11  
Bar holders 12-13  
Glass clamps 14-17  
Handrail accessories 20-22  
Side mounted bases 23  
Plates 24-25  
Tube fittings 26-29  
Lock cases 30-32  
Hinges 31  
Lever handle 33-36  
Wire rope and accessories 37-41

**Zinc**

Glass clamps 16-17

**Brass**

End caps 42  
Spheres 42  
Cover plates 43  
Handrail accessories 43  
Accessories 43

**Wrought Iron**

Anchor plates 44-45  
End caps 46  
Cover plates 46  
Spheres 47  
Scrolls 48-53  
Design bars 54  
U-Collars 55  
Ornamental balusters 56-63  
Forged balusters 64-65  
Starting posts 68  
Bar stock 69  
Handrail accessories 70  
Convex bar 71-72  
Spears & Lance Bars 73

Forged rosettes 74  
Forgings & Accessories 74  
Rings 75  
Ornaments - Leaves 75-77  
Door & gate curves 78  
Wrought iron handles 79  
Wrought iron lock plates 79  
Door hinges 80  
Wheels 81-82  
Stop for sliding gate 83  
Locks & Accessories 84-87

**Aluminium**

Aluminium handles 88-89

**Additives & Fasteners**

90-98

**Inox**

Coperchi per terminazioni tubi 4-5  
Sfere 6  
Accessori 6  
Copriflange 7  
Barre decorative 8-11  
Supporti per tubi 12-13  
Supporti a clip per vetro 14-17  
Accessori per corrimano 20-22  
Supporti da parete 23  
Placche 24-25  
Raccordi 26-27  
Raccordi per tubi 28-29  
Serrature 30-32  
Cerniere 31  
Maniglia 33-36  
Cavi metallici e accessori 37-41

**Zinco**

Supporti a clip per vetro 16-17

**Ottone**

Coperchi per terminazioni tubi 42  
Sfere 42  
Copriflange 43  
Accessori per corrimano 43  
Accessori 43

**Ferro Battuto**

Placche per fissaggio 44-45  
Coperchi per terminazioni tubi 46  
Copriflange 46  
Sfere 47  
Arrotolata 48-53  
Barre decorative 54  
Collari a U 55  
Balaustre 56-63  
Barre per balaustre, forgiate 64-65  
Barre semplici, di base 68  
Profili 69  
Accessori per corrimano 70  
Barra convessa 71-72  
Lance in ferro battuto 73

Rosette in ferro 74  
Ferro battuto & Accessori 74  
Anelli 75  
Oggetti ornamentali - Foglie 75-77  
Archi per porte e cancelli 78  
Maniglie in ferro battuto 79  
Placche per serratura in ferro battuto 79  
Cerniere 80  
Ruote 81-82  
Fermo per cancelli scorrevoli 83  
Serrature e Accessori 84-87

**Alluminio**

Maniglie in alluminio 88-89

**Additivi e prodotti per il fissaggio**

90-98

**Spedizioni e condizioni di pagamento**

99

**Paslanmaz Çelik**

Boru kapakları 4-5  
Küreler 6  
Aksesuarlar 6  
Rozetler 7  
Dizayn çubuklar 8-11  
Çubuk tutucu yüzükler 12-13  
Cam tutucuları 14-17  
Küpeşte aksesuarları 20-22  
Duvar montaj elemanları 23  
Pullar 24-25  
Bükümlü borular 26-27  
Geçme boru bağlantıları 28-29  
Kilit kasaları 30-32  
Menteşeler 31  
Kapı kolları 33-36  
Halat ve zincir sistemleri 37-41

**Zamak**

Cam tutucuları 16-17

**Pirinç**

Boru kapakları 42  
Küreler 42  
Rozetler 43  
Küpeşte aksesuarları 43  
Aksesuarlar 43

**Ferforje**

Montaj tablaları 44-45  
Boru kapakları 46  
Rozetler 46  
Küreler 47  
Motifler 48-53  
Dizayn çubuklar 54  
U-Bilezikler 55  
Motifli çubuklar 56-63  
Dövme çubuklar 64-65  
Babalar(Dikmeler) 68  
Boy malzemeler 69  
Küpeşte aksesuarları 70  
Cumbalar 71-72  
Mızraklar 73

Ferforje Rozetler 74  
Dövme parçalar 74  
Halkalar 75  
Ornamentler - Yapraklar 75-77  
Kemerli profiller 78  
Ferforje kapı kolları 79  
Ferforje aynalar 79  
Kapı menteşeleri 80  
Makaralar 81-82  
Kapı durdurucuları 83  
Kilitler & Aksesuarları 84-87

**Alüminyum**

Alüminyum kapı kolları 88-89

**Yardımcı malzemeler**

90-98



Rohrabschlussstopfen, gewölbt  
Embout de fermeture, Bombé  
End cap, Cambered  
Coperchio, Bombato  
Boru kapağı, Bombeli

øD x s /mm	Best.-Nr.
26,9 x 2,0	1004
33,7 x 2,0	1001
33,7 x 2,6	1005
42,4 x 2,0	1002
42,4 x 2,6	1006
48,3 x 2,0	1003
48,3 x 2,6	1007
60,3 x 2,0	1008



Rohrabschlussstopfen, gewölbt mit M8 Gewinde  
Embout de fermeture, Bombé avec filetage M8  
End cap, Cambered with M8-thread  
Coperchio, Coperchio bombato con foro filettato M8  
Boru kapağı, Bombeli M8-Dişli

øD x s /mm	Best.-Nr.
26,9 x 2,0	1004-G
33,7 x 2,0	1001-G
33,7 x 2,6	1005-G
42,4 x 2,0	1002-G
42,4 x 2,6	1006-G
48,3 x 2,0	1003-G
48,3 x 2,6	1007-G
60,3 x 2,0	1008-G



Rohrabschlussstopfen, flach  
Embout de fermeture, Plat  
End cap, Flat  
Coperchio, Piatto  
Boru kapağı, Düz

øD x s /mm	Best.-Nr.
26,9 x 2,0	1013
33,7 x 2,0	1010
33,7 x 2,6	1014
42,4 x 2,0	1011
42,4 x 2,6	1015
48,3 x 2,0	1012
48,3 x 2,6	1016
60,3 x 2,0	1017



Rohrabschlussstopfen, flach mit M8 Gewinde  
Embout de fermeture, Plat, filetage M8  
End cap, Flat, with M8-thread  
Coperchio, Piatto, con foro filettato M8  
Boru kapağı, Düz M8-Dişli

øD x s /mm	Best.-Nr.
26,9 x 2,0	1013-G
33,7 x 2,0	1010-G
33,7 x 2,6	1014-G
42,4 x 2,0	1011-G
42,4 x 2,6	1015-G
48,3 x 2,0	1012-G
48,3 x 2,6	1016-G
60,3 x 2,0	1017-G



Rohr-Kugelstopfen  
Embout hémisphérique  
Hemisphere end cap  
Coperchio semisferico  
Yarım küre boru kapağı

øD x s /mm	Best.-Nr.
26,9 x 2,0	1023
33,7 x 2,0	1020
33,7 x 2,6	1024
42,4 x 2,0	1021
42,4 x 2,6	1025
48,3 x 2,0	1022
48,3 x 2,6	1026



Rohr-Kugelstopfen, mit M8 Gewinde  
Embout hémisphérique, Filetage M8  
Hemisphere end cap, With M8- thread  
Coperchio semisferico, Con foro filettato M8  
Yarım küre boru kapağı, M8-Dişli

øD x s /mm	Best.-Nr.
26,9 x 2,0	1023-G
33,7 x 2,0	1020-G
33,7 x 2,6	1024-G
42,4 x 2,0	1021-G
42,4 x 2,6	1025-G
48,3 x 2,0	1022-G
48,3 x 2,6	1026-G

Top

V2A / INOX 304





Rohrabschlussstopfen, gewölbt mit 8 mm Bohrung  
Embout de fermeture, Bombé avec trou de 8 mm  
End cap, Cambered with 8 mm hole  
Coperchio, Bombato con foro da 8mm  
Boru kapağı, Bombeli 8 mm delikli

øD x s /mm	Best.-Nr.
26,9 x 2,0	1004-B
33,7 x 2,0	1001-B
33,7 x 2,6	1005-B
42,4 x 2,0	1002-B
42,4 x 2,6	1006-B
48,3 x 2,0	1003-B
48,3 x 2,6	1007-B
60,3 x 2,0	1008-B

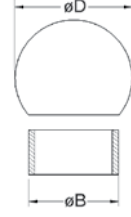
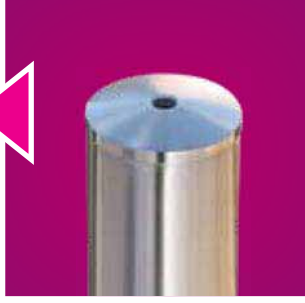

Rohr-Abschlusskugeln  
Embout sphérique / Sphere end cap  
Coperchio a sfera / Küre boru kapağı

øB /mm	øD /mm	Best.-Nr.
26,9	40	1050
33,7	45	1051
42,4	55	1052
48,3	60	1053

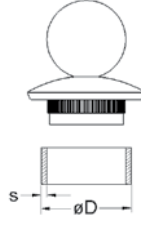

Rohr-Knopf  
Pommeaux / Knobs / Pomoli / Topuz

øD x s /mm	Best.-Nr.
33,7 x 2,0	1036
33,7 x 2,6	1037
42,4 x 2,0	1038
42,4 x 2,6	1039
48,3 x 2,0	1040
48,3 x 2,6	1041

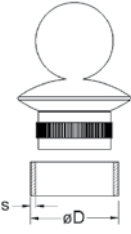
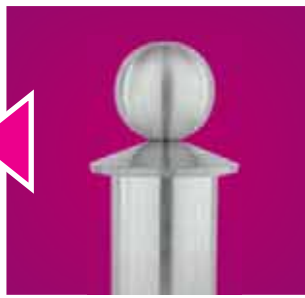

Rohr-Knopf  
Pommeaux / Knobs / Pomoli / Topuz

øD x s /mm	Best.-Nr.
33,7 x 2,0	1030
33,7 x 2,6	1033
42,4 x 2,0	1031
42,4 x 2,6	1034
48,3 x 2,0	1032
48,3 x 2,6	1035

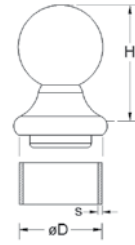

Rohr-Knopf  
Pommeaux / Knobs / Pomoli / Topuz

øD x s /mm	H /mm	Best.-Nr.
32,0 x 1,5	42	1042-32E
33,7 x 2,0	42	1042-33
38,0 x 1,5	53	1042-38E
42,4 x 1,5	53	1042-42E
42,4 x 2,0	53	1042-42

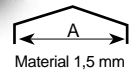
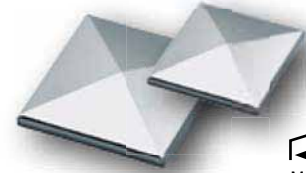
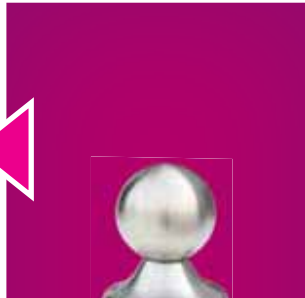

Abdeckkappen  
Embouts pyramidaux / Angular caps  
Coperchi quadrati ad angolo / Dört köşe kapak

A /mm	Best.-Nr.
30 x 30	1660-3030
30 x 40	1660-3040
40 x 40	1660-4040
50 x 50	1660-5050
60 x 60	1660-6060
80 x 80	1660-8080
100 x 100	1660-1010
120 x 120	1660-1212

## AK INOX

### Hohlkugeln / Sphères Spheres / Sfere / Küreler



Hohlkugeln  
Sphères / Spheres / Sfere / Küreler

øD /mm	Best.-Nr.
20 massiv	1600
25 massiv	1601
30 massiv	1602
40	1603
50	1604
60	1605
70	1606
80	1607
90	1608
100	1609
120	1610
150	1611
200	1612



Halbhohlkugeln  
Demi-sphère / Hemisphere  
Semisfera / Yarım Küre

øD /mm	Best.-Nr.
20	1640
26,9	1641
30	1642
33,7	1653
40	1643
42,4	1654
48,3	1655
50	1644
60	1645
70	1646
80	1647
90	1648
100	1649
120	1650
150	1651
200	1652

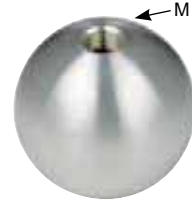

Hohlkugeln, mit Gewinde  
Sphères, avec pas de vis / Spheres, with screw hole  
Sfere, con foro filettato / Küre, vida delikli

øD /mm	M	Best.-Nr.
20	M6	1600-G
25	M6	1601-G
30	M6	1602-G
40	M8	1603-G
50	M8	1604-G
60	M8	1605-G
70	M8	1606-G
80	M10	1607-G
90	M10	1608-G
100	M10	1609-G
120	M10	1610-G
150	M12	1611-G
200	M12	1612-G

Kugel mit Sackloch / Embout sphérique  
Sphere end cap / Coperchio a sfera / Küre, kör delikli

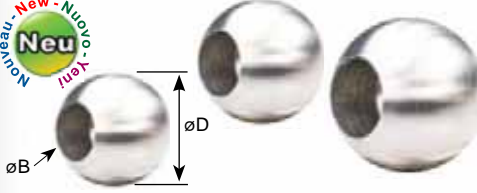

øD /mm	øB /mm	Best.-Nr.
20	12	1600-12
25	12	1601-12
30	12	1602-12

V2A / INOX 304

## AK INOX

### Zierteile / Accessoires Accessories / Accessori / Aksesuarlar

ø 24 x 50 mm zum Kleben	
øB /mm	Best.-Nr.
10,2	1980-10
12,2	1980-12
14,2	1980-14

ø 24 x 40 mm zum Kleben	
øB /mm	Best.-Nr.
10,2	1981-10
12,2	1981-12
14,2	1981-14

ø 24 x 18 mm zum Kleben	
øB /mm	Best.-Nr.
10,2	1982-10
12,2	1982-12
14,2	1982-14

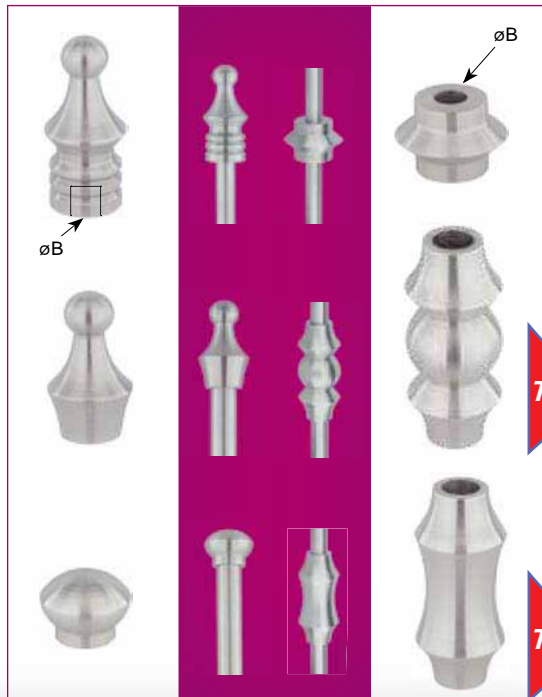

ø 35 x 24 mm mit Klemmschraube	
øB /mm	Best.-Nr.
10,2	1983-10
12,2	1983-12
14,2	1983-14

ø 30 x 70 mm mit Klemmschraube	
øB /mm	Best.-Nr.
10,2	1984-10
12,2	1984-12
14,2	1984-14

ø 30 x 70 mm mit Klemmschraube	
øB /mm	Best.-Nr.
10,2	1985-10
12,2	1985-12
14,2	1985-14

Top

Top



ø 50 x 8 mm

øB /mm	Best.-Nr.
10,5	1207-10
12,5	1207-12
14,5	1207-14



ø 68 x 12 mm

øB /mm	Best.-Nr.
12,5	1205-12
34,0	1205-34



ø 75 x 12 mm

øB /mm	Best.-Nr.
12,5	1206-12
14,5	1206-14
34,0	1206-34
43,0	1206-43
49,0	1206-49



ø 85 x 12 mm

øB /mm	Best.-Nr.
12,5	1218-12
14,5	1218-14
34,0	1218-34



ø 75 x 22 mm

øB /mm	Best.-Nr.
12,5	1210-12
14,5	1210-14
34,0	1210-34



ø 85 x 22 mm

øB /mm	Best.-Nr.
12,5	1219-12
14,5	1219-14
34,0	1219-34



ø 105 x 22 mm

øB /mm	Best.-Nr.
34,0	1216-34
43,0	1216-43
49,0	1216-49



ø 125 x 22 mm

øB /mm	Best.-Nr.
43,0	1217-43
49,0	1217-49



ø 75 x 24 mm

øB /mm	Best.-Nr.
12,5	1201-12
14,5	1201-14
34,0	1201-34



ø 85 x 24 mm

øB /mm	Best.-Nr.
12,5	1202-12
14,5	1202-14
34,0	1202-34



ø 105 x 38 mm

øB /mm	Best.-Nr.
34,0	1203-34
43,0	1203-43
49,0	1203-49



ø 125 x 38 mm

øB /mm	Best.-Nr.
43,0	1204-43
49,0	1204-49



**Designstäbe / Barreaux design**  
**Design bars / Barre decorative / Dizayn Çubuklar**

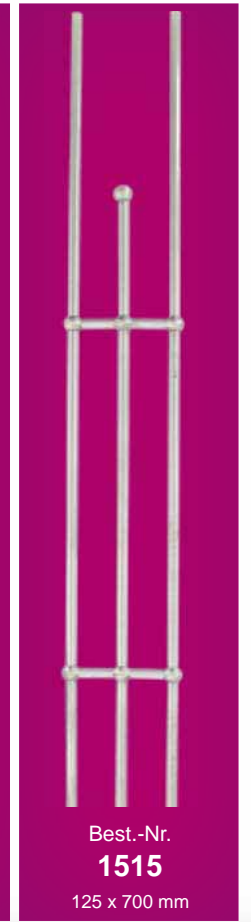
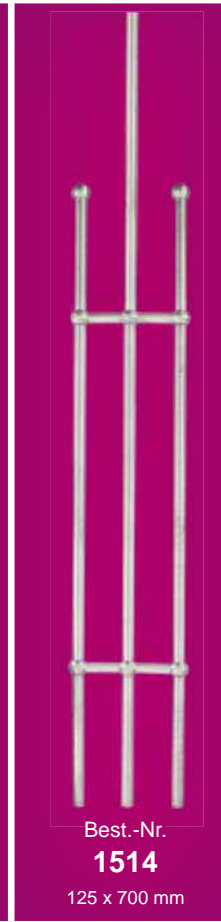
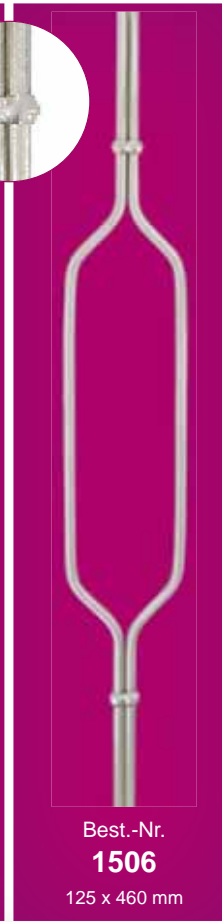
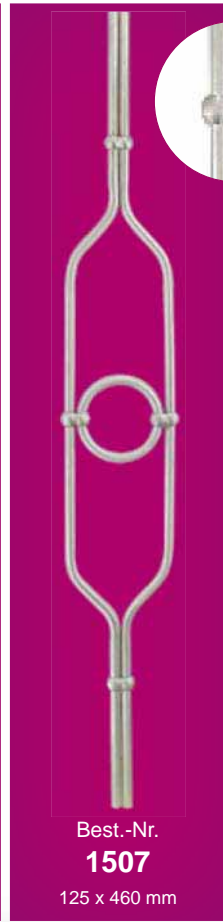
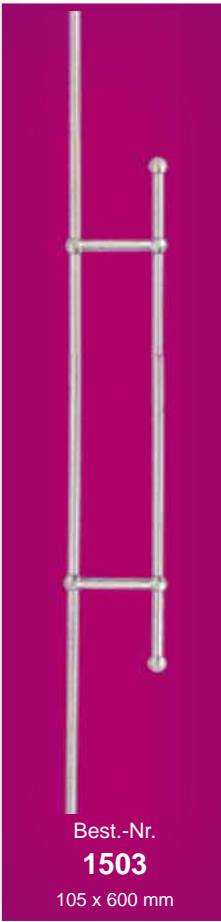
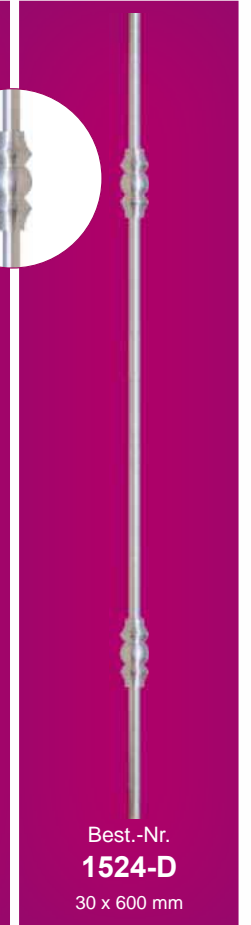
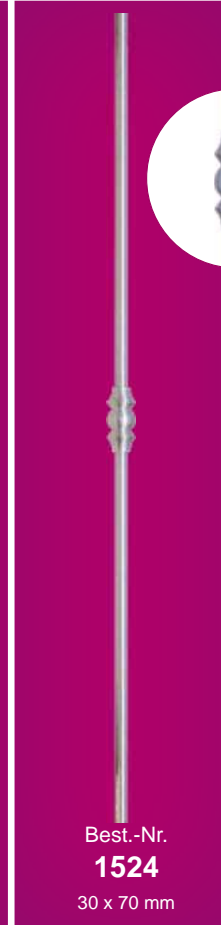
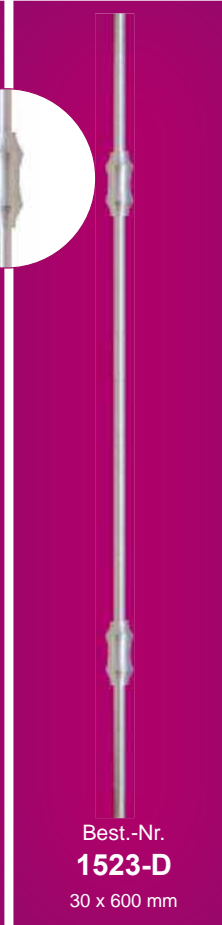
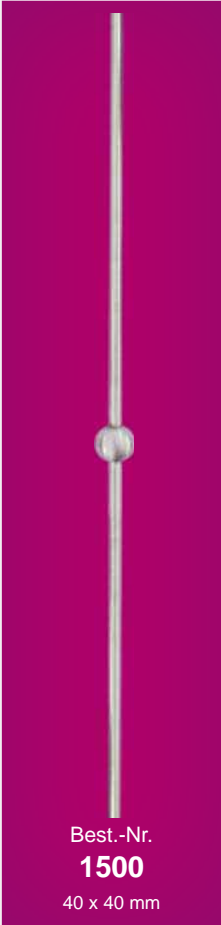

V2A / INOX 304



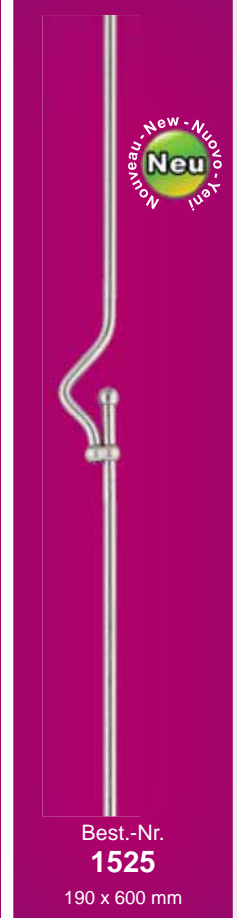
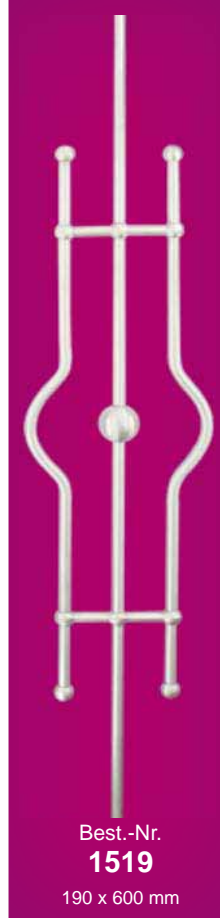
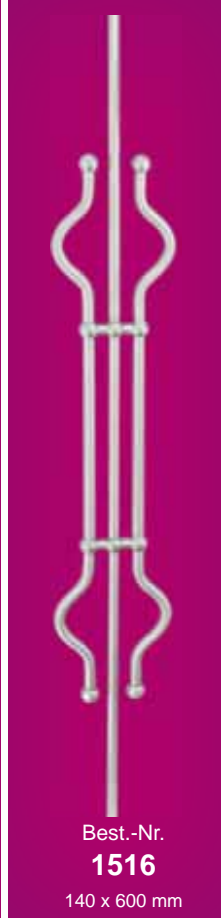

Neu  
New - Nuovo - Yeni

Neu  
New - Nuovo - Yeni

**Oval - Ringe / Anneau oval**  
**Oval ring / Anello ovale / Oval halka**

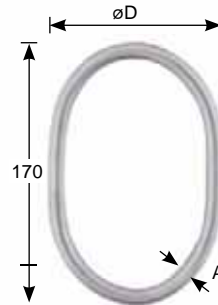

Neu  
New - Nuovo - Yeni

øD /mm	A /mm	Best.-Nr.
100	12	1581-100-12
110	12	1581-110-12
120	12	1581-120-12

**Ringe / Anneau**  
**Ring / Anello / Halka**

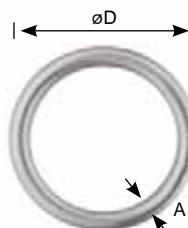

Neu  
New - Nuovo - Yeni

øD /mm	A /mm	Best.-Nr.
100	12	1580-100-12
110	12	1580-110-12
120	12	1580-120-12

Edelstahlverarbeitung Stemke, D-79353 Bahlingen



V2A / INOX 304

Metallbau Cziesp, D - 26345 Bockhorn



Edelstahlverarbeitung Stemke, D-79353 Bahlingen

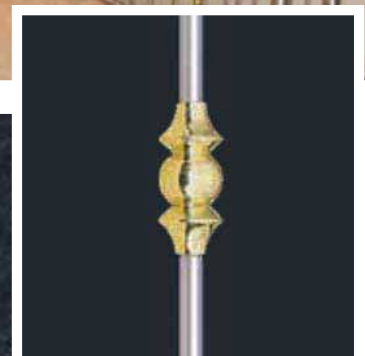



Edelstahlverarbeitung Sternke, D-79353 Bahlingen



Bauschosserei Hauck, D - 97267 Himmelstadt



Bauschosserei Hauck, D - 97267 Himmelstadt



Egon Haist GmbH, D - 72270 Baiersbronn



V2A / INOX 304

## Querstabhalter mit Rundanschluss

Support transversal percé, terminaison concave / Bar holder with concave back  
Supporto per tubo con lato concavo / Çubuk tutucu yüzük, arkası radyuslu

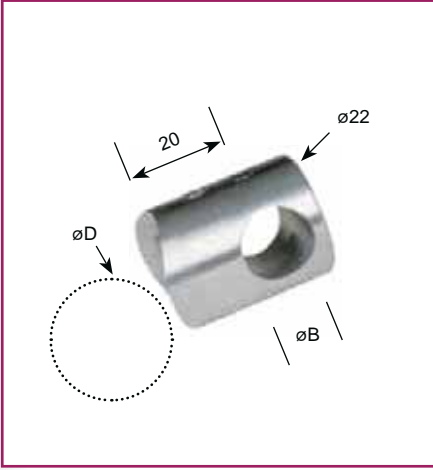

øD /mm	øB /mm	Best.-Nr.
33,7	10,2	1970-3310
33,7	12,2	1970-3312
42,4	10,2	1970-4210
42,4	12,2	1970-4212
48,3	10,2	1970-4810
48,3	12,2	1970-4812

øD /mm	øB /mm	Best.-Nr.
33,7	10,2	1971-3310
33,7	12,2	1971-3312
42,4	10,2	1971-4210
42,4	12,2	1971-4212
48,3	10,2	1971-4810
48,3	12,2	1971-4812

øD /mm	øB /mm	Best.-Nr.
33,7	10,2	1972-3310
33,7	12,2	1972-3312
42,4	10,2	1972-4210
42,4	12,2	1972-4212
48,3	10,2	1972-4810
48,3	12,2	1972-4812

## Querstabhalter mit Rundanschluss und Sackloch

Support transversal percé, trou borgne / End post bar holder with concave back  
Supporto cieco per tubo con lato concavo / Arkası radyuslu çubuk tutucu kör yüzük

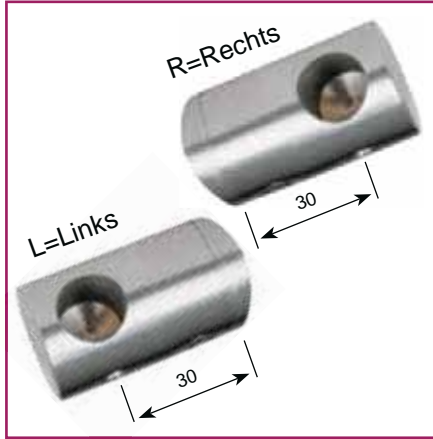

øD /mm	øB /mm	Best.-Nr.
33,7	10,2	1973-3310-R
33,7	10,2	1973-3310-L
33,7	12,2	1973-3312-R
33,7	12,2	1973-3312-L
42,4	10,2	1973-4210-R
42,4	10,2	1973-4210-L
42,4	12,2	1973-4212-R
42,4	12,2	1973-4212-L
48,3	10,2	1973-4810-R
48,3	10,2	1973-4810-L
48,3	12,2	1973-4812-R
48,3	12,2	1973-4812-L

øD /mm	øB /mm	Best.-Nr.
33,7	10,2	1974-3310-R
33,7	10,2	1974-3310-L
33,7	12,2	1974-3312-R
33,7	12,2	1974-3312-L
42,4	10,2	1974-4210-R
42,4	10,2	1974-4210-L
42,4	12,2	1974-4212-R
42,4	12,2	1974-4212-L
48,3	10,2	1974-4810-R
48,3	10,2	1974-4810-L
48,3	12,2	1974-4812-R
48,3	12,2	1974-4812-L

øD /mm	øB /mm	Best.-Nr.
33,7	10,2	1975-3310-R
33,7	10,2	1975-3310-L
33,7	12,2	1975-3312-R
33,7	12,2	1975-3312-L
42,4	10,2	1975-4210-R
42,4	10,2	1975-4210-L
42,4	12,2	1975-4212-R
42,4	12,2	1975-4212-L
48,3	10,2	1975-4810-R
48,3	10,2	1975-4810-L
48,3	12,2	1975-4812-R
48,3	12,2	1975-4812-L



## Querstabhalter mit Flachanschluss

Support transversal percé, terminaison droite / Bar holder with flat back  
Supporto per tubo con lato piatto / Çubuk tutucu yüzük, arkası düz

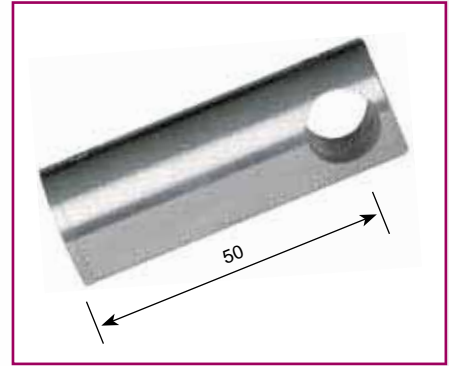
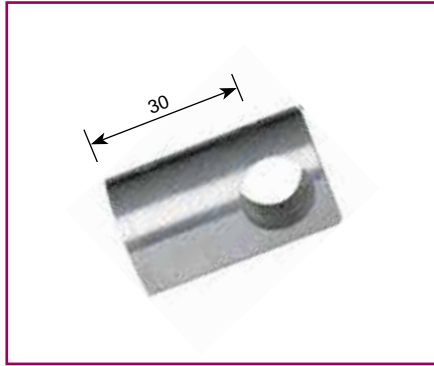
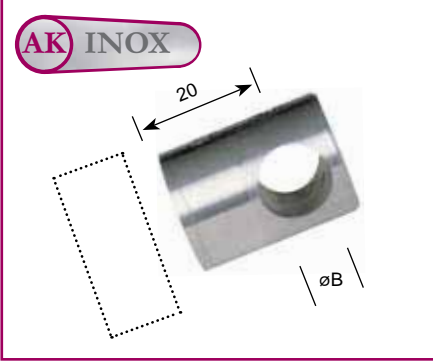

øB /mm	Best.-Nr.
10,2	1970-10
12,2	1970-12

øB /mm	Best.-Nr.
10,2	1971-10
12,2	1971-12

øB /mm	Best.-Nr.
10,2	1972-10
12,2	1972-12

## Querstabhalter mit Flachanschluss und Sackloch

Support transversal percé, trou borgne, terminaison droite / End post bar holder with flat back  
Supporto cieco per tubo con lato piatto / Arkası düz çubuk tutucu kör yüzük

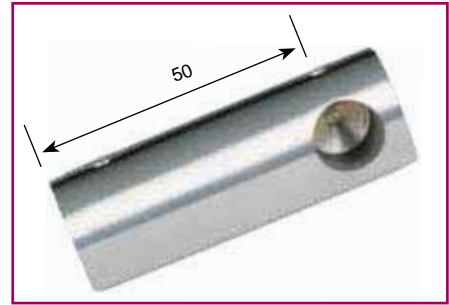
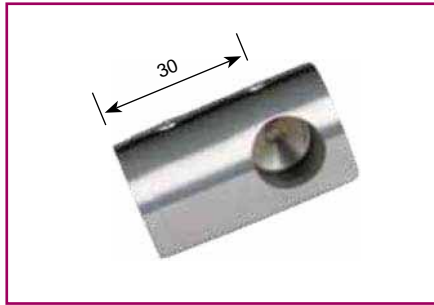
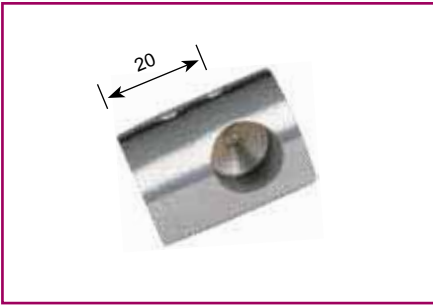

øB /mm	Best.-Nr.
10,2	1973-10-R
10,2	1973-10-L
12,2	1973-12-R
12,2	1973-12-L

øB /mm	Best.-Nr.
10,2	1974-10-R
10,2	1974-10-L
12,2	1974-12-R
12,2	1974-12-L

øB /mm	Best.-Nr.
10,2	1975-10-R
10,2	1975-10-L
12,2	1975-12-R
12,2	1975-12-L

**New - Nuovo - Yeni**

øD /mm	øB /mm	Best.-Nr.
42,4	10,2	1970-4210 D
42,4	12,2	1970-4212 D

**"ecoline"** **Top**

øD /mm	øB /mm	Best.-Nr.
42,4	12,2	1970-4212 E

**Querstabhalter mit Doppelbohrung**  
Support transversal percé, deux trous  
Bar holder with double hole  
Supporto per tubo con doppio foro  
Çift delikli çubuk tutucu

**New - Nuovo - Yeni**

øB /mm	Best.-Nr.
10,2 - 12,2	1976-1012
12,2 - 12,2	1976-1212

INOX Form 1

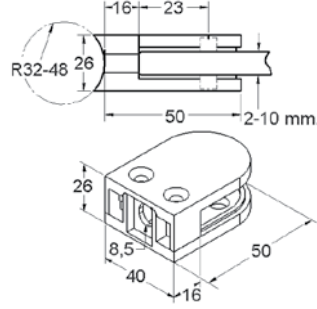

Für Flach (G)  
Profil plat  
Flat Back  
Profilo piatto  
Düz tabana  
monte

Für Rund (R)  
Profil incurvé  
Curved Back  
Profilo ricurvo  
Yuvarlak boruya  
monte

Für Glas  
Epaisseur de vitre  
Glass thickness  
Spessore del vetro  
Cam kalınlığı

00 ø 32, 42, 48 mm 2-10 mm

	R /mm	Best.-Nr.
V2A / Inox 304	00	1841-G
	32	1841-R32
	42	1841-R42
	48	1841-R48
V4A / Inox 316	00	1840-G
	32	1840-R32
	42	1840-R42
	48	1840-R48

INOX Form 2

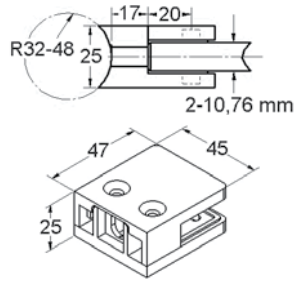

Für Flach (G)  
Profil plat  
Flat Back  
Profilo piatto  
Düz tabana  
monte

Für Rund (R)  
Profil incurvé  
Curved Back  
Profilo ricurvo  
Yuvarlak boruya  
monte

Für Glas  
Epaisseur de vitre  
Glass thickness  
Spessore del vetro  
Cam kalınlığı

00 ø 32, 42, 48 mm 2-10,76 mm

	R /mm	Best.-Nr.
V2A / Inox 304	00	1851-G
	32	1851-R32
	42	1851-R42
	48	1851-R48
V4A / Inox 316	00	1850-G
	32	1850-R32
	42	1850-R42
	48	1850-R48

INOX Form 3

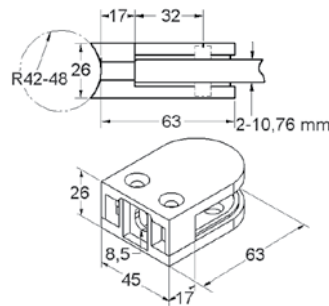

Für Flach (G)  
Profil plat  
Flat Back  
Profilo piatto  
Düz tabana  
monte

Für Rund (R)  
Profil incurvé  
Curved Back  
Profilo ricurvo  
Yuvarlak boruya  
monte

Für Glas  
Epaisseur de vitre  
Glass thickness  
Spessore del vetro  
Cam kalınlığı

00 ø 32, 42, 48 mm 2-10,76 mm

	R /mm	Best.-Nr.
V2A / Inox 304	00	1861-G
	32	1861-R32
	42	1861-R42
	48	1861-R48
V4A / Inox 316	00	1860-G
	32	1860-R32
	42	1860-R42
	48	1860-R48

Für Flach (G)  
Profil plat  
Flat Back  
Profilo piatto  
Düz tabana  
monte

Für Rund (R)  
Profil incurvé  
Curved Back  
Profilo ricurvo  
Yuvarlak boruya  
monte

Für Glas  
Epaisseur de vitre  
Glass thickness  
Spessore del vetro  
Cam kalınlığı

00 ø 42, 48, 60 mm 10-12,76 mm

	R /mm	Best.-Nr.
V2A / Inox 304	00	1881-G
	42	1881-R42
	48	1881-R48
	60	1881-R60
V4A / Inox 316	00	1880-G
	42	1880-R42
	48	1880-R48
	60	1880-R60

INOX Form 4

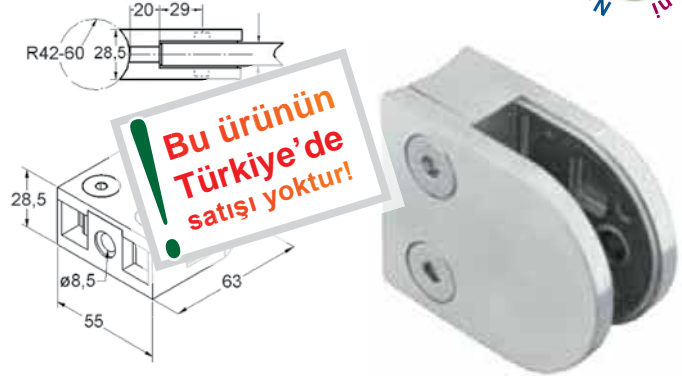

Für Flach (G)  
Profil plat  
Flat Back  
Profilo piatto  
Düz tabana  
monte

Für Rund (R)  
Profil incurvé  
Curved Back  
Profilo ricurvo  
Yuvarlak boruya  
monte

Für Glas  
Epaisseur de vitre  
Glass thickness  
Spessore del vetro  
Cam kalınlığı

00 ø 42, 48, 60 mm 10-12,76 mm

	R /mm	Best.-Nr.
V2A / Inox 304	00	1891-G
	42	1891-R42
	48	1891-R48
	60	1891-R60
V4A / Inox 316	00	1890-G
	42	1890-R42
	48	1890-R48
	60	1890-R60

INOX Form 5



Bitte vergessen Sie nicht, bei Ihrer Bestellung Glasstärke und Glasart (VSG oder ESG) anzugeben.

N'oubliez pas dire l'épaisseur et le type de vitre (sécurité ou laminé) dans vos commandes.

Don't forget to notify thickness and kind of glass (security or laminated) in your orders.

Cortesemente, menzionare lo spessore e la tipologia di vetro (di sicurezza o laminato) nel vostro ordine

Lütfen cam tutucusunda kullanılan cam kalınlığını ve özelliğini (lamine veya emniyet camı) belirtiniz.



INOX Form 8

	R /mm	Best.-Nr.
V2A / Inox 304	00	1871-G
	32	1871-R32
	42	1871-R42
	48	1871-R48
V4A / Inox 316	00	1870-G
	32	1870-R32
	42	1870-R42
	48	1870-R48



## AK INOX

Blechhalter mit Flachanschluss  
Pince de fixation droite  
Clamp holder with flat back  
Portatarga piatto  
Plaka tutucu, arkası düz

Blechhalter mit Rundanschluss  
Pince de fixation concave  
Clamp holder with concave back  
Portatarga ricurvo  
Plaka tutucu, arkası radyuslu

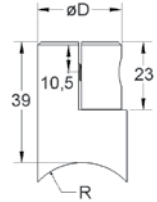
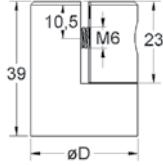

	R /mm	Best.-Nr.	D = ø 32mm Best.-Nr.
V2A / Inox 304	00	1887-G	1886-G
	32	1887-R32	1886-R32
	42	1887-R42	1886-R42
	48	1887-R48	1886-R48

## AK ZAMAK

Klemmbefestigungen / Pinces de vitre  
Glass clamps / Supporti a clip per vetro / Cam tutucuları

Für Flach (G)  
Profil plat  
Flat Back  
Profilo piatto  
Düz tabana  
monte

Für Rund (R)  
Profil incurvé  
Curved Back  
Profilo ricurvo  
Yuvarlak boruya  
monte

Für Glas  
Epaisseur de vitre  
Glass thickness  
Spessore del vetro  
Cam kalınlığı

00

ø 32, 42, 48 mm

2-10 mm

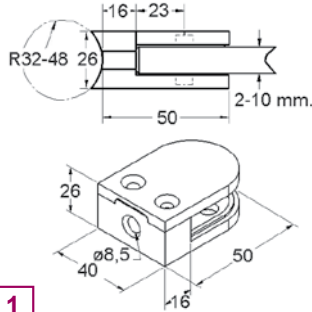

ZAMAK Form 1

Oberfläche  
Revêtement  
Surface  
Superficie  
Yüzey

R /mm

Best.-Nr.

Zink  
Zinc Mat  
Zamak  
Zinco  
Zamak

00

1811-G

32

1811-R32

42

1811-R42

48

1811-R48

Edelstahl-Effekt  
Apparence inox  
Inox Visual  
Simil-Inox  
Paslanmaz Görünüm

00

1819-G

32

1819-R32

42

1819-R42

48

1819-R48

RAL 9010

Weiss  
Blanc  
White  
Bianco  
Beyaz

00

1812-G

32

1812-R32

42

1812-R42

48

1812-R48

Für Flach (G)  
Profil plat  
Flat Back  
Profilo piatto  
Düz tabana  
monte

Für Rund (R)  
Profil incurvé  
Curved Back  
Profilo ricurvo  
Yuvarlak boruya  
monte

Für Glas  
Epaisseur de vitre  
Glass thickness  
Spessore del vetro  
Cam kalınlığı

00

ø 32, 42, 48 mm

2-10,76 mm

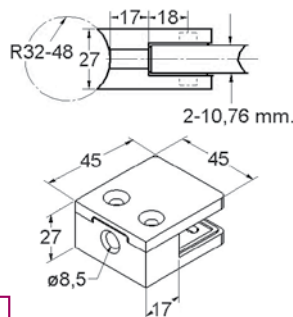

ZAMAK Form 2

Oberfläche  
Revêtement  
Surface  
Superficie  
Yüzey

R /mm

Best.-Nr.

Zink  
Zinc Mat  
Zamak  
Zinco  
Zamak

00

1821-G

32

1821-R32

42

1821-R42

48

1821-R48

Edelstahl-Effekt  
Apparence inox  
Inox Visual  
Simil-Inox  
Paslanmaz Görünüm

00

1829-G

32

1829-R32

42

1829-R42

48

1829-R48

RAL 9010

Weiss  
Blanc  
White  
Bianco  
Beyaz

00

1822-G

32

1822-R32

42

1822-R42

48

1822-R48



Oberflaeche Revêtement Surface Superficie Yüzey	R /mm	Best.-Nr.
Zink Zinc Mat Zamak	00	1831-G
Zinco Zamak	32	1831-R32
	42	1831-R42
	48	1831-R48
Edelstahl-Effekt Apparence inox Inox Visual Simil-Inox Paslanmaz Görünüm	00	1839-G
	32	1839-R32
	42	1839-R42
	48	1839-R48
RAL 9010 Weiss Blanc White Bianco Beyaz	00	1832-G
	32	1832-R32
	42	1832-R42
	48	1832-R48

Für Flach (G) Profil plat Flat Back Profilo piatto Düz tabana monte	Für Rund (R) Profil incurvé Curved Back Profilo ricurvo Yuvarlak boruya monte	Für Glas Epaisseur de vitre Glass thickness Spessore del vetro Cam kalınlığı
00	ø 32, 42, 48 mm	2-10,76 mm

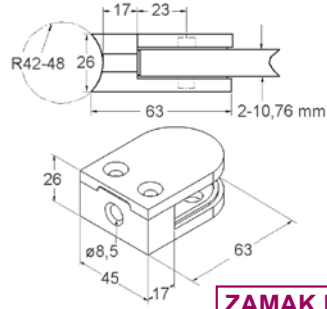

ZAMAK Form 3

Oberflaeche Revêtement Surface Superficie Yüzey	R /mm	Best.-Nr.
Zink Zinc Mat Zamak	00	1885-G
Zinco Zamak	42	1885-R42
	48	1885-R48
	60	1885-R60
Edelstahl-Effekt Apparence inox Inox Visual Simil-Inox Paslanmaz Görünüm	00	1889-G
	42	1889-R42
	48	1889-R48
	60	1889-R60
RAL 9010 Weiss Blanc White Bianco Beyaz	00	1882-G
	42	1882-R42
	48	1882-R48
	60	1882-R60

Für Flach (G) Profil plat Flat Back Profilo piatto Düz tabana monte	Für Rund (R) Profil incurvé Curved Back Profilo ricurvo Yuvarlak boruya monte	Für Glas Epaisseur de vitre Glass thickness Spessore del vetro Cam kalınlığı
00	ø 42, 48, 60 mm	10-12,76 mm



ZAMAK Form 4

Neu - New - Nuovo - Yeni

**Bu ürünün Türkiye'de satışı yoktur!**

Oberflaeche Revêtement Surface Superficie Yüzey	R /mm	Best.-Nr.
Zink Zinc Mat Zamak	00	1895-G
Zinco Zamak	42	1895-R42
	48	1895-R48
	60	1895-R60
Edelstahl-Effekt Apparence inox Inox Visual Simil-Inox Paslanmaz Görünüm	00	1899-G
	42	1899-R42
	48	1899-R48
	60	1899-R60
RAL 9010 Weiss Blanc White Bianco Beyaz	00	1892-G
	42	1892-R42
	48	1892-R48
	60	1892-R60

Für Flach (G) Profil plat Flat Back Profilo piatto Düz tabana monte	Für Rund (R) Profil incurvé Curved Back Profilo ricurvo Yuvarlak boruya monte	Für Glas Epaisseur de vitre Glass thickness Spessore del vetro Cam kalınlığı
00	ø 42, 48, 60 mm	10-12,76 mm



ZAMAK Form 5

Neu - New - Nuovo - Yeni

**Bu ürünün Türkiye'de satışı yoktur!**



Metallbau Dotterweich GmbH & Co KG, D-97497 Dingolshausen



Metallbau Dotterweich GmbH & Co KG, D-97497 Dingolshausen



Fa. Bauer, D - 53489 Sinzig



Fa. Bauer, D - 53489 Sinzig



Fa. Bauer, D - 53489 Sinzig



Fa. Bauer, D - 53489 Sinzig





Ebert Metalldesign, D- 65396 Walluf



Ebert Metalldesign, D- 65396 Walluf



Gisela Grote GmbH & Co KG, D - 34260 Kaufingen

Ebert Metalldesign, D- 65396 Walluf

Top

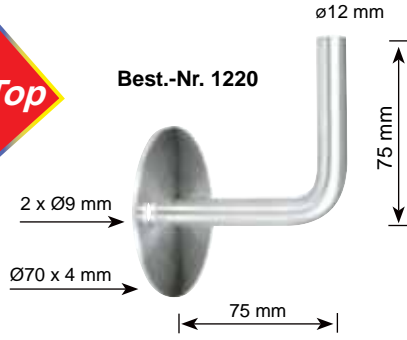

Top



øD/mm	Best.-Nr.
33,7	1268-33
42,4	1268-42
48,3	1268-48

øD/mm	Best.-Nr.
33,7	1267-33
42,4	1267-42
48,3	1267-48

øD/mm	Best.-Nr.
33,7	1266-33
42,4	1266-42
48,3	1266-48

**"ecoline"**

øDxs /mm	H /mm	Best.-Nr.
32,0 x 1,5	24	1269-32E
33,7 x 2,0	24	1269-33
38,0 x 1,5	24	1269-38E
42,4 x 1,5	25	1269-42E
42,4 x 2,0	25	1269-42

**"ecoline"**

øDxs /mm	H /mm	Best.-Nr.
32,0 x 1,5	21	1270-32E
33,7 x 2,0	21	1270-33
38,0 x 1,5	22	1270-38E
42,4 x 1,5	22	1270-42E
42,4 x 2,0	22	1270-42



**Best-Nr. 1225**  
Ø12 mm  
75 mm  
75 mm

**Best-Nr. 1226**  
75 mm  
75 mm

**Best-Nr. 1229**  
100  
70  
M8 x 10 mm

**Best-Nr. 1229-G**  
100  
70  
M8 x 10 mm

**Best-Nr. 1228**  
75 mm  
75 mm  
M8 x 10 mm

**Best-Nr. 1247-10**  
øD /mm øD1 /mm  
60 10

**Best-Nr. 1247-12**  
70 12

**Best-Nr. 1247-10-G**  
øD /mm øD1 /mm  
60 10

**Best-Nr. 1247-12-G**  
70 12

**Best-Nr. 1280**  
33,7 65

**Best-Nr. 1281**  
42,4 65

**Best-Nr. 1282**  
48,3 65

**Best-Nr. 1283**  
33,7 80

**Best-Nr. 1284**  
42,4 80

**Best-Nr. 1285**  
48,3 80

**Best-Nr. 1280**  
øD /mm L /mm  
33,7 65

**Best-Nr. 1281**  
42,4 65

**Best-Nr. 1282**  
48,3 65

**Best-Nr. 1283**  
33,7 80

**Best-Nr. 1284**  
42,4 80

**Best-Nr. 1285**  
48,3 80

**Best-Nr. 1279-65**  
L x w x s /mm  
65x25x3

**Best-Nr. 1290**  
L /mm  
65

**Best-Nr. 1291**  
100

**Best-Nr. 1292**  
L /mm  
65

**Best-Nr. 1293**  
100



Handlaufträger mit Abschlusskugel  
Support de main courante avec anneau borgne  
Handrail bracket with blind sphere ring  
Supporto semisferico cieco per corrimano  
Kolçak, kör küre yüzüklü

øD /mm	Best.-Nr.
33,7	1250
42,4	1251

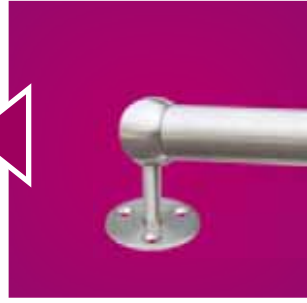

Handlaufträger mit Kugelring  
Support de main courante avec anneau  
Handrail bracket with sphere ring  
Supporto ad anello sferico per corrimano  
Kolçak, küre yüzüklü

øD /mm	Best.-Nr.
33,7	1252
42,4	1253

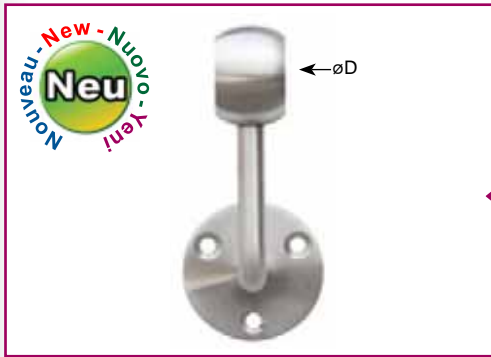

Handlaufträger mit Kugelring  
Support de main courante avec anneau  
Handrail bracket with sphere ring  
Supporto ad anello sferico per corrimano  
Kolçak, küre yüzüklü

øD /mm	Best.-Nr.
33,7	1245
42,4	1246

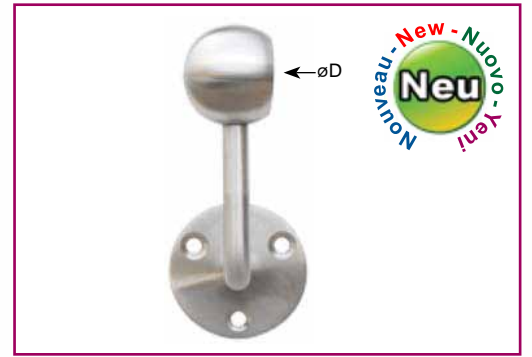
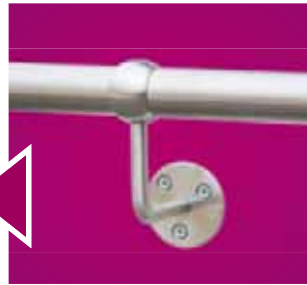

Handlaufträger mit Abschlusskugel  
Support de main courante avec anneau borgne  
Handrail bracket with blind sphere ring  
Supporto semisferico cieco per corrimano  
Kolçak, kör küre yüzüklü

øD /mm	Best.-Nr.
33,7	1243
42,4	1244

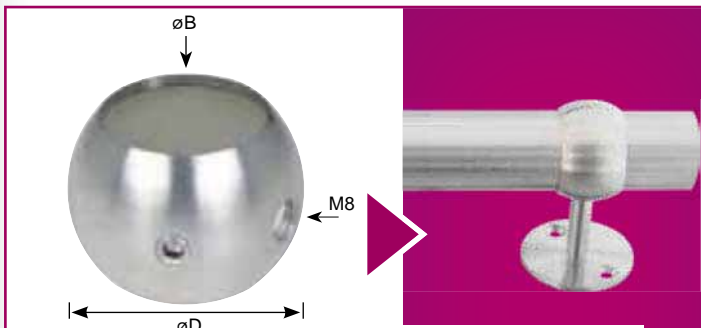

Kugel-Ring  
Anneau sphérique / Sphere ring  
Supporto ad anello sferico per corrimano / Küre yüzük

øB /mm	øD /mm	Best.-Nr.
26,9	40	1054
33,7	45	1055
42,4	55	1056
48,3	60	1057

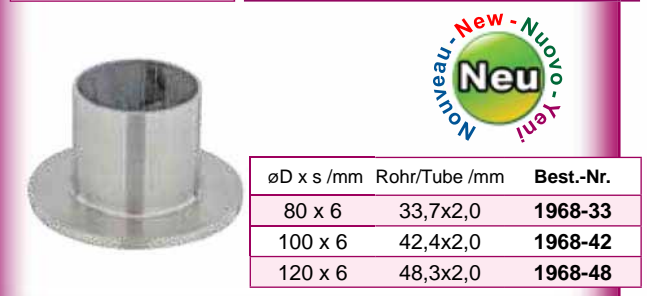
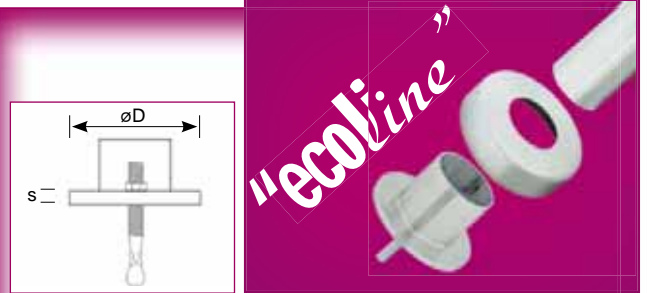

øD x s /mm	Rohr/Tube /mm	Best.-Nr.
80 x 6	33,7x2,0	1968-33
100 x 6	42,4x2,0	1968-42
120 x 6	48,3x2,0	1968-48

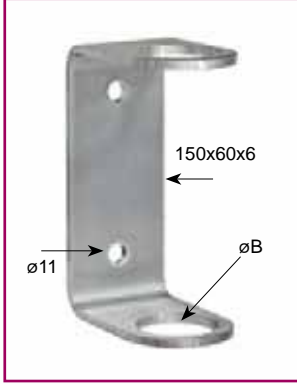

øB /mm	Best.-Nr.
34	1963-33
43	1963-42
49	1963-48

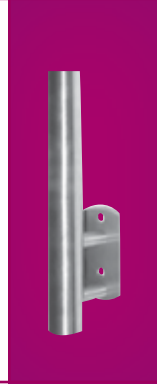
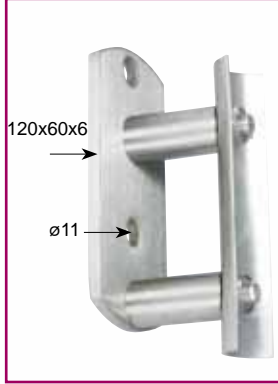

Rohr/Tube /mm	Best.-Nr.
33,7	1961-33
42,4	1961-42
48,3	1961-48

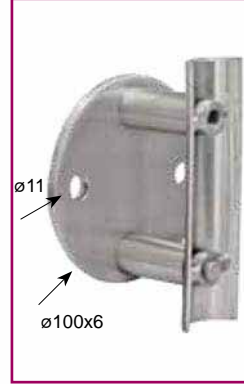

Rohr/Tube /mm	Best.-Nr.
33,7	1960-33
42,4	1960-42
48,3	1960-48

**Abstandshülse / Rallonge / Extension bar / Estensione / Montaj Çubuğu**

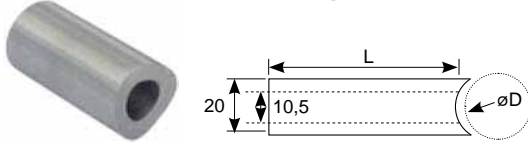

L /mm	øD /mm	Best.-Nr.
40	33,7	1969-40
70	42,4	1969-70
100	48,3	1969-100



øB /mm	Best.-Nr.
33,7	1962-33
42,4	1962-42
48,3	1962-48



øB /mm	Best.-Nr.
33,7	1964-33
42,4	1964-42
48,3	1964-48

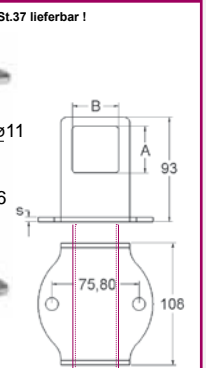
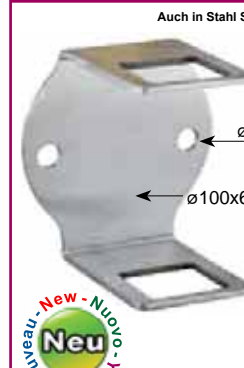

A /mm	B /mm	Best.-Nr.
30	30	1965-30
40	40	1965-40

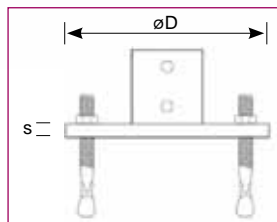

øD x s /mm	Rohr/Tube /mm	Best.-Nr.
80 x 6	33,7x2,0	1966-33
100 x 6	42,4x2,0	1966-42
120 x 6	48,3x2,0	1966-48

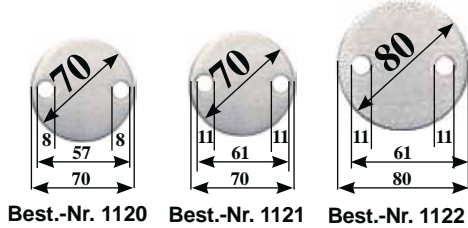
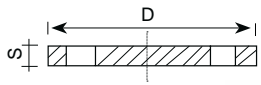

Best.-Nr. 1120 Best.-Nr. 1121 Best.-Nr. 1122

D x s /mm	Best.-Nr.
70 x 4	1120
70 x 6	1121
80 x 6	1122

Alle Ronden mit „plus Service“ Kanten bearbeitet!

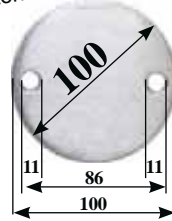

Best.-Nr. 1123

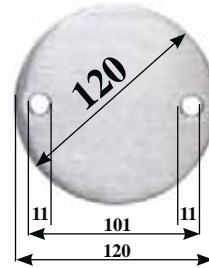

Best.-Nr. 1124

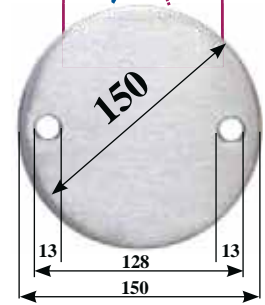

Best.-Nr. 1128

**Top**

D x s /mm	Best.-Nr.
100 x 6	1123

D x s /mm	Best.-Nr.
120 x 6	1124
150 x 6	1128

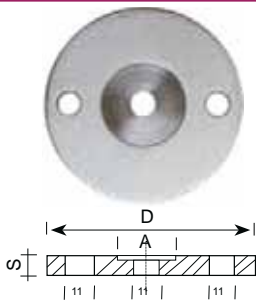

D x s /mm	A /mm	Best.-Nr.
80 x 6	34 x 1	1127-34
100 x 6	43 x 1	1127-43
120 x 6	49 x 1	1127-49

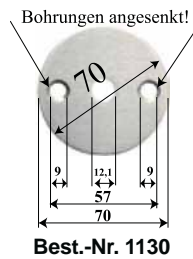

Best.-Nr. 1130

D x s /mm	Best.-Nr.
70 x 4	1130

Alle Ronden mit „plus Service“ Kanten bearbeitet!

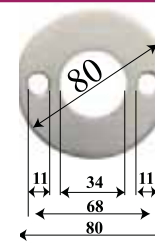

Best.-Nr. 1131

D x s /mm	Best.-Nr.
80 x 6	1131

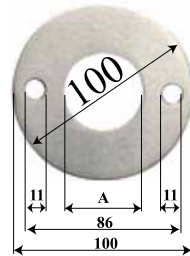

D x s /mm	A /mm	Best.-Nr.
100 x 6	34	1132-34
100 x 6	43	1132-43
100 x 6	49	1132-49

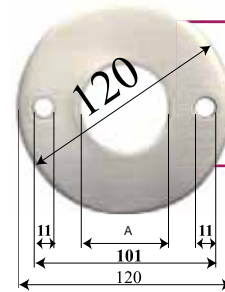

D x s /mm	A /mm	Best.-Nr.
120 x 6	34	1133-34
120 x 6	43	1133-43
120 x 6	49	1133-49



D x s /mm	Best.-Nr.
27 x 2	1111
33 x 2	1112
33 x 4	1100
42 x 2	1113
42 x 4	1101
48 x 4	1102
60 x 4	1103
70 x 4	1104
70 x 6	1105
80 x 4	1106
80 x 6	1107
100 x 4	1108
100 x 6	1109
120 x 6	1110
150 x 6	1114

Schale gewölbt, ungeschliffen

Embout bombé, non poli / Domed cap, unpolished  
Coperchio a cupola, grezzo / Bombeli kapak, polisajsız

Material 2,0 mm



ø /mm	h /mm	Zoll	Best.-Nr.
21	6	1/2"	1200-21
27	7	3/4"	1200-27
33	8	1"	1200-33
42	9	1 1/4"	1200-42
48	10	1 1/2"	1200-48
52	10	1 3/4"	1200-52
60	11	2"	1200-60
70	11	2 1/4"	1200-70
76	11	2 1/2"	1200-76
89	12	3"	1200-89
101	12	3 1/2"	1200-101
113	13	4"	1200-113
120	13	4 1/2"	1200-120



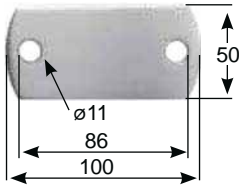

Best.-Nr. 1140

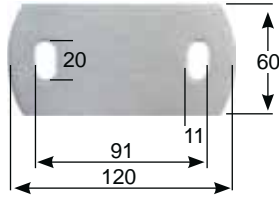

Best.-Nr. 1141

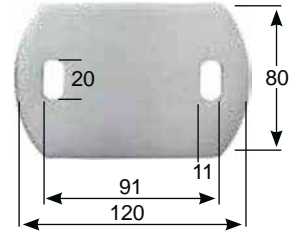

Best.-Nr. 1142

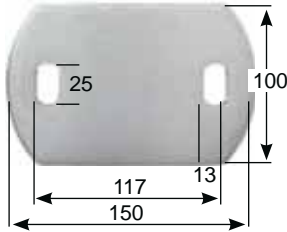

Best.-Nr. 1145

B x H x s /mm	Best.-Nr.
100x50x6	1140
120x60x6	1141
120x80x6	1142
150x100x6	1145
200x125x6	1146

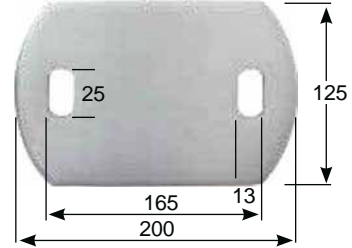

Best.-Nr. 1146

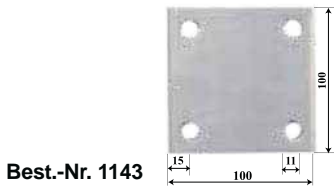

Best.-Nr. 1143

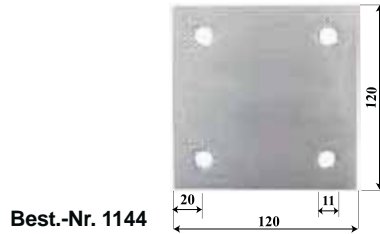

Best.-Nr. 1144



Alle Ronden mit „plus Service“ Kanten bearbeitet!

B x H x s /mm	Best.-Nr.
100x100x6	1143

B x H x s /mm	Best.-Nr.
120x120x6	1144

D x s /mm	Best.-Nr.
64 x 4	1125
64 x 4	1126

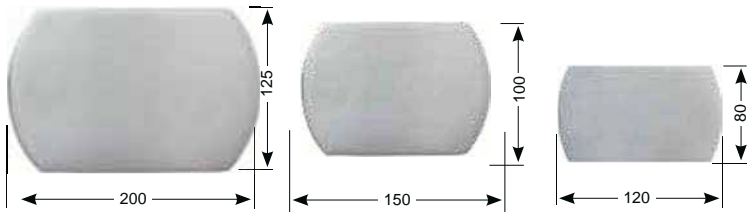

Best.-Nr. 1144-OB

∅D x s /mm	Best.-Nr.	Paket/Stk/paquet
100x100x6	1143-OB	65
120x 80x6	1142-OB	100
120x120x6	1144-OB	44
150x100x6	1145-OB	40
200x125x6	1146-OB	25

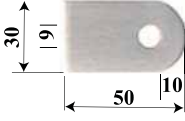

Best.-Nr. 1151

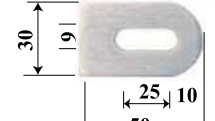

Best.-Nr. 1150

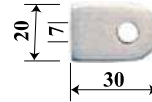

Best.-Nr. 1152

B x H x s /mm	Best.-Nr.
50 x 30 x 4	1150
50 x 30 x 4	1151
30 x 20 x 4	1152

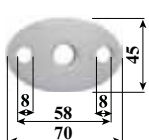

Best.-Nr. 1160

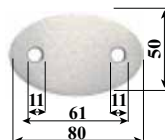

Best.-Nr. 1161

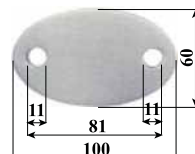

Best.-Nr. 1162

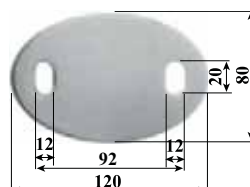

Best.-Nr. 1163

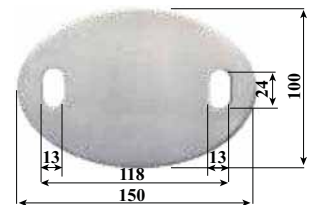

Best.-Nr. 1164

B x H x s /mm	Best.-Nr.
70 x 45 x 4	1160
80 x 50 x 4	1161

B x H x s /mm	Best.-Nr.
100 x 60 x 6	1162
120 x 80 x 6	1163

B x H x s /mm	Best.-Nr.
150 x 100 x 6	1164

**AK INOX**

**Rohrbögen / Tubes incurvés**  
**Curved tubes / Tubi ricurvi / Bükümlü borular**

90°

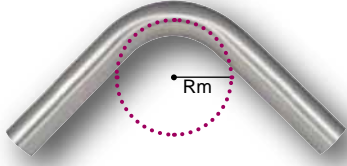
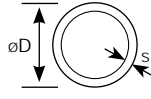

øD x s /mm	Rm	Best.-Nr.
26,9 x 2,0	54	1904-26
33,7 x 2,0	68	1904-33
33,7 x 2,6	68	1904-3326
42,4 x 2,0	86	1904-42
42,4 x 2,6	86	1904-4226
48,3 x 2,6	98	1904-48

120°

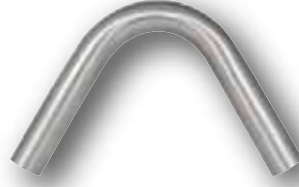

øD x s /mm	Rm	Best.-Nr.
26,9 x 2,0	54	1905-26
33,7 x 2,0	68	1905-33
33,7 x 2,6	68	1905-3326
42,4 x 2,0	86	1905-42
42,4 x 2,6	86	1905-4226
48,3 x 2,6	98	1905-48

180°



øD x s /mm	Rm	Best.-Nr.
26,9 x 2,0	54	1906-26
33,7 x 2,0	68	1906-33
33,7 x 2,6	68	1906-3326
42,4 x 2,0	86	1906-42
42,4 x 2,6	86	1906-4226
48,3 x 2,6	98	1906-48

30°



øD x s /mm	Rm	Best.-Nr.
26,9 x 2,0	54	1901-26
33,7 x 2,0	68	1901-33
33,7 x 2,6	68	1901-3326
42,4 x 2,0	86	1901-42
42,4 x 2,6	86	1901-4226
48,3 x 2,6	98	1901-48

45°



øD x s /mm	Rm	Best.-Nr.
26,9 x 2,0	54	1902-26
33,7 x 2,0	68	1902-33
33,7 x 2,6	68	1902-3326
42,4 x 2,0	86	1902-42
42,4 x 2,6	86	1902-4226
48,3 x 2,6	98	1902-48

60°



øD x s /mm	Rm	Best.-Nr.
26,9 x 2,0	54	1903-26
33,7 x 2,0	68	1903-33
33,7 x 2,6	68	1903-3326
42,4 x 2,0	86	1903-42
42,4 x 2,6	86	1903-4226
48,3 x 2,6	98	1903-48

60°

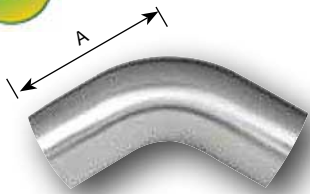

øD x s /mm	A	Best.-Nr.
42,4 x 2,0	79	1903-42-K

45°

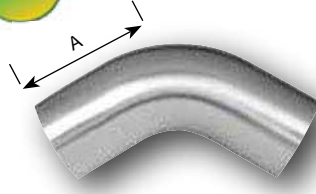

øD x s /mm	A	Best.-Nr.
42,4 x 2,0	73	1902-42-K

30°

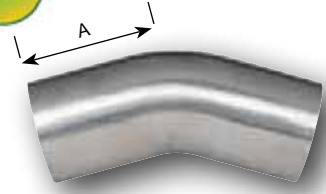

øD x s /mm	A	Best.-Nr. Code
42,4 x 2,0	73	1901-42-K

V2A / INOX 304

90°

Poliert  
Poli / Polished  
Lucidato / Polisajlı

90° Schweißbogen / Coude  
Elbow / Raccordo a gomito / Dirsek  
HP- Hochglanz / Haut polissage  
Highly polished / Lucidato a specchio / Parlak

Top



45°



New - Nuovo - Yeni

øD x s /mm	Rm	Best.-Nr
26,9 x 2,0	27	1924-26
32,0 x 1,5	38	1924-32
32,0 x 1,5	38	1924-32HP
33,7 x 2,0	35	1924-33
42,4 x 2,0	44	1924-42
48,3 x 2,6	54	1924-48
50,8 x 1,5	58	1924-51
50,8 x 1,5	58	1924-51HP

øD x s /mm	Best.-Nr.
33,7 x 2,0	1924-3345
42,4 x 2,0	1924-4245
48,3 x 2,0	1924-4845

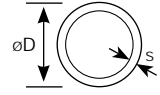
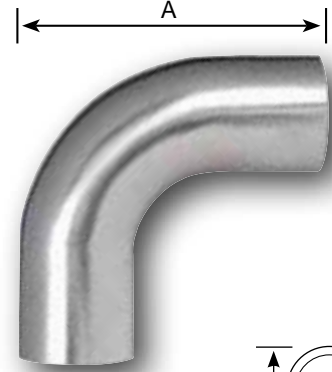

Rohrbogen kurz / Raccord arqué court  
Bent tube fitting, short / Raccordo per tubo, corto  
Bükümlü boru bağlantı elemanı, kısa

øD x s /mm	A /mm	Best.-Nr.
42,4 x 2,0	110	1904-42-K

## Rohrbögen mit Bohrung / Tubes incurvés percés

Tube fittings with holes / Raccordi forati per tubi / Konektör boru bağlantıları

60°

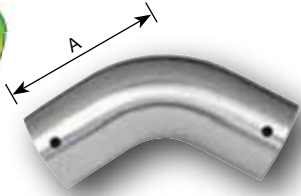

45°

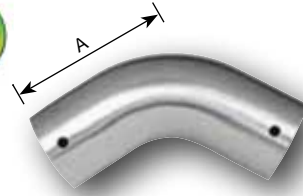

30°

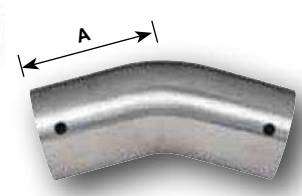

øD x s /mm	A /mm	Best.-Nr.
42,4 x 2,0	79	1903-42-KB

øD x s /mm	A /mm	Best.-Nr.
42,4 x 2,0	73	1902-42-KB

øD x s /mm	A /mm	Best.-Nr.
42,4 x 2,0	73	1901-42-KB

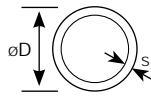
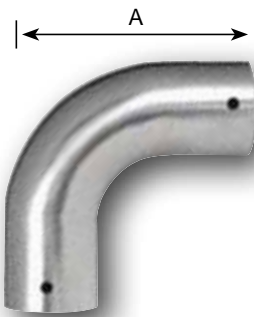

øD x s /mm	A /mm	Best.-Nr.
42,4 x 2,0	110	1904-42-KB

## Verbindungshülse / Raccord / Connector / Raccordo / Konektör



Mit Klemmschrauben  
Avec vis de serrage / With clamp screws  
Con viti a pressione / Sıkıştırma vidaları ile

Passend für Rohrwandstärke 2,0–2,6 mm  
Convient à une épaisseur de tube de 2,0 à 2,6 mm  
Suitable for 2,0-2,6 mm thickness of tube  
Per tubi di spessore 2,0-2,6 mm  
2,0-2,6 mm boru kalınlığına göre

8 mm vorgebohrt für Aufnahme der Verbindungshülse  
Trou de 8 mm sur le tube  
8 mm hole on the face of tube  
Foro da 8 mm sulla superficie del tubo  
Boru ağzında açılan 8 mm delik



Rohr/Tube /mm	Best.-Nr.
26,9	1951-26
33,7	1951-33
42,4	1951-42
48,3	1951-48

Verbindungshülse einstecken und Gewindestift (im Lieferumfang enthalten) festziehen. Fertig ist die Verbindung in Sekunden !



Rohr/Tube /mm	90 - 145° Best.-Nr.	100 - 165° Best.-Nr.
33,7 x 2,0	1937-1-33	1937-2-33
42,4 x 2,0	1937-1-42	1937-2-42
48,3 x 2,0	1937-1-48	1937-2-48



Rohr/Tube /mm	Best.-Nr.
33,7 x 2,0	1938-33
42,4 x 2,0	1938-42
48,3 x 2,0	1938-48



Rohr/Tube /mm	Best.-Nr.
33,7 x 2,0	1936-33
42,4 x 2,0	1936-42
48,3 x 2,0	1936-48



Rohr/Tube /mm	Best.-Nr.
33,7 x 2,0	1933-33
42,4 x 2,0	1933-42
48,3 x 2,0	1933-48



Rohr/Tube /mm	Best.-Nr.
33,7	1930-33
42,4	1930-42
48,3	1930-48



Rohr/Tube /mm	Best.-Nr.
33,7	1931-33
42,4	1931-42
48,3	1931-48

Passend für Rohrwandstärke 2,0–2,6 mm  
Convient à une épaisseur de tube de 2,0 à 2,6 mm  
Suitable for 2,0-2,6 mm thickness of tube  
Per tubi di spessore 2,0-2,6 mm  
2,0-2,6 mm boru kalınlığına göre

WEICON Klebstoffe / Adhésifs / Adhesivi / Epoxi yapıştırıcıları / Yapıştırıcılar



**COSMOPLAST 500L**

ein schnellhärtender 1-Komponenten-Klebstoff für die handwerkliche und industrielle Anwendung  
cyan-acrylic adhesive

Best.-Nr. 25116  
20 ml,



WEICONLOCK products are high quality anaerobic adhesives and sealants on the basis of special methacrylate resins, especially made for economical threadlocking, retaining and sealing of threaded, cylindrical and pipe

Best.-Nr. 25110  
20 ml,



**Epoxyd-Minutenkleber**

2-Komponenten, transparente und restelastisch aushärtende, Klebstoffe, welche die meisten Materialien, wie: Metall, Glas, Stein, Keramik, Holz und viele Kunststoffe mit- und untereinander verbinden.

WEICON Epoxy Minute Adhesive  
This transparent adhesive retains elasticity after curing and is ideal for jobs in construction and assembly and in fact in all cases where the use of WEICON Easy-Mix Systems would not be efficient. viscous, self-levelling very short pot life (3 - 4 minutes) fast-curing almost colourless, glass clear.

Best.-Nr. 25113  
24 ml,



**AK** INOX

**Steckfittings / Raccords**

**Tube fittings / Raccordi per tubi / Geçme boru bağlantıları**



Rohr Tube /mm	Best.-Nr.
33,7 x 2,0	1911-33
42,4 x 2,0	1911-42
48,3 x 2,0	1911-48

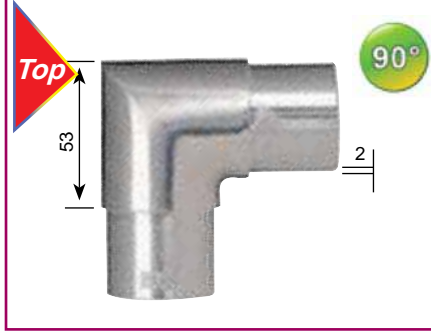

Rohr Tube /mm	Best.-Nr.
33,7 x 2,0	1910-33
42,4 x 2,0	1910-42
48,3 x 2,0	1910-48



Rohr Tube /mm	Best.-Nr.
42,4 x 2,0	1913-42



Rohr Tube /mm	Best.-Nr.
33,7 x 2,0	1918-33
42,4 x 2,0	1918-42
48,3 x 2,0	1918-48



Rohr Tube /mm	Best.-Nr.
33,7 x 2,0	1919-33
42,4 x 2,0	1919-42
48,3 x 2,0	1919-48



Rohr Tube /mm	Best.-Nr.
33,7 x 2,0	1912-33
42,4 x 2,0	1912-42
48,3 x 2,0	1912-48

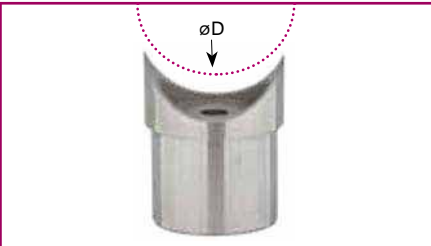

øD /mm	Best.-Nr.
33,7 x 2,0	1916-33
42,4 x 2,0	1916-42
48,3 x 2,0	1916-48

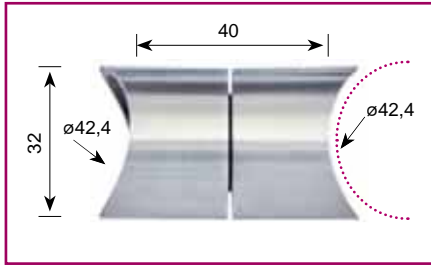

Anschlussstück Connecteur / Connecting fitting Connettore / Bağlantı parçası	
Rohr Tube /mm	Best.-Nr.
42,4-42,4	1925-4242

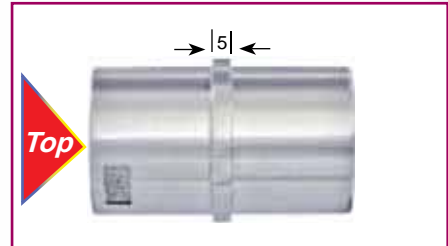

Rohr Tube /mm	Best.-Nr.
33,7 x 2,0	1917-33
42,4 x 2,0	1917-42
48,3 x 2,0	1917-48

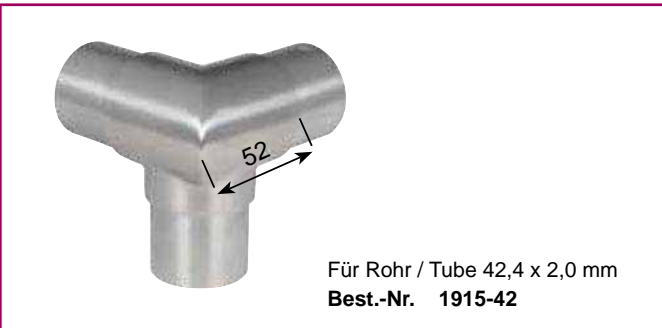

## Schlossgehäuse und Gegenkästen / Boîtiers de serrure et gâches Locking and striking cases / Serratura e controbocchetta / Kilit ve karşılık kasaları



Schlossgehäuse,  
Links oder Rechts verwendbar, 2-tourig  
Boîtier en inox,  
Disponibile droite et gauche, à 2 tours.  
Lock case,  
Left or right side usage with 2-tours lock.  
Serratura,  
Utilizzabile sia a destra che a sinistra,  
scrocco a doppio giro.  
Kilit kasası  
Sağ ve Sol olarak kullanılabilir,  
iki türlü kilit ile.

B x H x T /mm	Best.-Nr.
96 x 172 x 30	1304-30
96 x 172 x 34	1304-34
96 x 172 x 40	1304-40
96 x 172 x 50	1304-50

E = 72 mm, A = 60 mm



Gegenkasten  
Gehäuse und Schliessblech  
Gâche,  
Boîtier et platine de gâche  
Striking case,  
Lock case and striking plate  
Controbocchetta,  
Serratura e controbocchetta  
Karşılık kasası  
Kasa ve ayna

B x H x T /mm	Best.-Nr.
96 x 172 x 30	1324-30
96 x 172 x 34	1324-34
96 x 172 x 40	1324-40
96 x 172 x 50	1324-50



Schmales Schlossgehäuse,  
Links oder Rechts verwendbar, 1-tourig  
Boîtier de serrure étroit,  
Utilisable droite et gauche, serrure à un tour  
Narrow lock case,  
Left or right side usage with 1-tour lock  
Serratura stretta,  
Utilizzo a destra o sinistra, serratura a giro singolo  
Dar kilit kasası  
Sağ ve sol olarak kullanılabilir, bir türlü kilit ile

B x H x T /mm	Best.-Nr.
60 x 172 x 30	1305
60 x 172 x 40	1305-40



Schlossgehäuse mit Hakenfalle  
Boîtier de serrure à crochet pour porte  
coulissante  
Lock case for sliding doors with hook  
Serratura per porta scorrevole, ad uncino  
Kilit kasası kancalı kilit ile

B x H x T /mm	Best.-Nr.
96 x 172 x 30	1306-30
96 x 172 x 34	1306-34
96 x 172 x 40	1306-40
96 x 172 x 50	1306-50



Schliesskasten, links oder rechts verwendbar  
1 + 2 für Elektrischer Türöffner  
Gâche à encastrer, utilisable droite et gauche  
1 + 2 pour gâche électrique  
Striking box, left or right side usage  
1 + 2 for electric door opener  
Scatola di chiusura, utilizzo a sinistra o a destra  
1 + 2 per apertura elettrica  
Kilitleme kasaları, Sağ ve sol olarak kullanılabilir

B x H x T /mm	1 Best.-Nr.	2 Best.-Nr.	3 Best.-Nr.
45 x 172 x 30	1325-30	1326-30	1327-30
45 x 172 x 34	1325-34	1326-34	1327-34
45 x 172 x 40	1325-40	1326-40	1327-40

### Schliessbleche / Platines de gâche Striking plates / Controbocchetta / Kilit aynaları

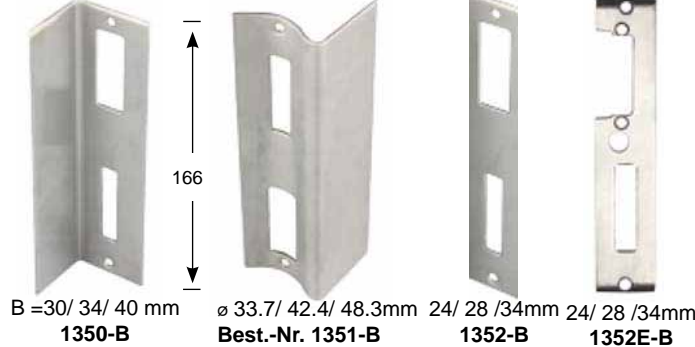

B = 30/ 34/ 40 mm  
1350-B  
ø 33.7/ 42.4/ 48.3mm  
Best.-Nr. 1351-B  
24/ 28 /34mm  
1352-B  
24/ 28 /34mm  
1352E-B



Elektrischer Türöffner mit Entriegelung,  
Links oder Rechts verwendbar  
Gâche électrique avec levier de déblocage.,  
Utilisable droite et gauche  
Electric door opener with mechanical release.,  
Left or right side usage  
Apertura elettrica con meccanismo a rilascio  
meccanico,  
Utilizzo a sinistra o a destra  
Elektrikli kapı açma otomatığı  
Sağ ve sol olarak kullanılabilir

6-12V AC/DC,  
67 x 16,5 x 28,5 mm

Best.-Nr. 10270



Design-Schlossgehäuse,  
Links oder Rechts verwendbar, 2-tourig  
Boîtier de serrure design ,  
Disponible droite et gauche, à 2 tours.  
Design lock case,  
Left or right side usage with 2-tours lock.  
Serratura design,  
Utilizzabile sia a destra che a sinistra, scrocco a doppio giro.  
Dizayn kilit kasası,  
Sağ ve Sol olarak kullanılabilir, iki türlü kilit ile.

Anschluss "Rund" / Fixation pour barreau  
"Round" connection Attacco speciale per incastro su tubi  
Boruya montaj için

øD /mm	B x H x T /mm	Best.-Nr.
42,4	130 x 250 x 42,4	1301-42
48,3	130 x 250 x 48,3	1301-48

E = 72 mm, A = 60 mm



Design-Schlossgehäuse,  
Links oder Rechts verwendbar, 2-tourig  
Boîtier de serrure design ,  
Disponible droite et gauche, à 2 tours.  
Design lock case,  
Left or right side usage with 2-tours lock.  
Serratura design,  
Utilizzabile sia a destra che a sinistra, scrocco a doppio giro.  
Dizayn kilit kasası,  
Sağ ve Sol olarak kullanılabilir, iki türlü kilit ile.

B x H x T /mm	Best.-Nr.
130 x 250 x 30	1302-30
130 x 250 x 34	1302-34
130 x 250 x 40	1302-40

E = 72 mm, A = 60 mm



Design-Gegenkasten,  
Links oder Rechts verwendbar  
Gâche design ,  
Utilisable droite et gauche  
Design striking case,  
Left or right side usage  
Controbocchetta design,  
Utilizzo a sinistra o a destra  
Dizayn karşılık kasası,  
Sağ ve sol olarak kullanılabilir

Anschluss "Rund" / Fixation pour barreau  
"Round" connection Attacco speciale per incastro su tubi  
Boruya montaj için

øD /mm	B x H x T /mm	Best.-Nr.
42,4	130 x 250 x 42,4	1321-42
48,3	130 x 250 x 48,3	1321-48



Design-Gegenkasten,  
Links oder Rechts verwendbar  
Gâche design ,  
Utilisable droite et gauche  
Design striking case,  
Left or right side usage  
Controbocchetta design,  
Utilizzo a sinistra o a destra  
Dizayn karşılık kasası,  
Sağ ve sol olarak kullanılabilir

B x H x T /mm	Best.-Nr.
130 x 250 x 30	1322-30
130 x 250 x 34	1322-34
130 x 250 x 40	1322-40

**Torriegel für Hangschloss**  
**Verrou au sol pour porte / Door bolt**  
**Chiavistello / Kapı Sürgüsü**

L /mm	B /mm	A /mm	s /mm	Best.-Nr.
200	55	25	8	1360-200





**AK INOX** Torbänder / Gonds / Hinges / Cerniere / Menteşeler

**Torband verstellbar**  
**Charnière réglable**  
**Adjustable hinge**  
**Cerniera regolabile**  
**Ayarlı menteşe**



øD /mm	L /mm	Best.-Nr.
M12	65	1390-12
M12	100	1390-12L
M16	65	1390-16
M20	65	1390-20

**Torband zweiteilig**  
**Charnière à souder**  
**Weld-on hinge**  
**Cerniera**  
**Mil menteşe**



øD x L /mm	Best.-Nr.
20 x 70	1391-20
24 x 85	1391-24

**Torband zweiteilig zur Verschraubung**  
**Charnière à visser**  
**Hinge to screw**  
**Cerniera a vite**  
**Vidalanan mil menteşe**



øD x L /mm	Best.-Nr.
20 x 70	1392-20
24 x 85	1392-24

ø20 mm = M6  
ø24 mm = M8



# Akbaz

Konkuk & Metal Ürünleri



P & H Saffra GdbR, D - 91301 Forchheim



helu Maschinenbau GmbH & Co. KG, A - 6232 Münster



P & H Saffra GdbR, D - 91301 Forchheim

V2A / INOX 304



**Türdrücker - Hohl / Poignées de porte - Creuses**  
**Lever handles - Hollow / Maniglie - Vuote all'interno / Kapı kolları - içi boş**



140 x 60 mm  
Best.-Nr. 1700



140 x 60 mm  
Best.-Nr. 1701



140 x 60 mm  
Best.-Nr. 1701-SH



140 x 60 mm  
Best.-Nr. 1702



140 x 60 mm  
Best.-Nr. 1703



140 x 60 mm  
Best.-Nr. 1704



**Kartoninhalt**  
Zwei Türgriffe  
Zwei Drücker-Rosetten  
Zwei Schlüssel-Rosetten  
Schrauben  
Vierkantstift (8x100 mm)

**Contenud'une boîte**  
Deux poignées  
Deux rosettes de poignée  
Deux rosettes de serrure  
Vis  
Branche quadrangulaire

**Box contents**  
Two lever handles  
Two handle rosettes  
Two lock rosettes  
Screws  
Profile spindle

**Contenuto della scatola**  
Due maniglie  
Due rosette per maniglie  
Due rosette per serratura  
Viti  
Barra di connessione

**Kutu içeriği**  
İki kapı kolu  
İki kol rozeti  
İki kilit rozeti  
Vidalalar  
Kapı kolu pimi



140 x 60 mm  
Best.-Nr. 1707



140 x 60 mm  
Best.-Nr. 1712



140 x 60 mm  
Best.-Nr. 1713



140 x 60 mm  
Best.-Nr. 1714



140 x 60 mm  
Best.-Nr. 1715



140 x 60 mm  
Best.-Nr. 1716



**Türdrücker - Massiv / Poignées de porte - Pleines**  
**Lever handles - Solid / Maniglie massicce / Kapı kolları - içi dolu**



140 x 60 mm  
Best.-Nr. 1707



140 x 60 mm  
Best.-Nr. 1708



140 x 60 mm  
Best.-Nr. 1709



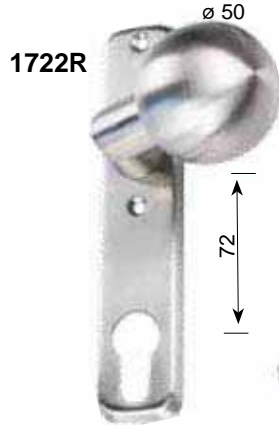
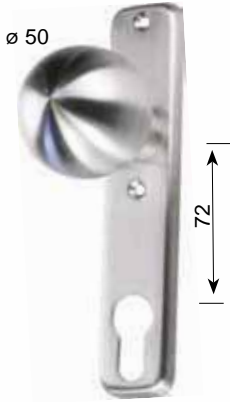

Fest / Fixe / Fixed / Fisso / Sabit

Best.-Nr.  
1720

Best.-Nr.  
1722R Rechts / a droite / right / a destra  
1722L Links / a gauche / left / a sinistra

KS = 155 x 32 mm

Best.-Nr.  
1700-KS

Drehbar / Pivotante / Turnable / Girevole / Çevrilebilir

Best.-Nr.  
1721

Best.-Nr.  
1723



Best.-Nr.  
1701-LS

Best.-Nr.  
1700-LS



Fest / Fixe / Fixed / Fisso / Sabit

Best.-Nr.  
1724

Best.-Nr.  
1725

Best.-Nr.  
1727

Best.-Nr.  
1728

Best.-Nr.  
1729

Drehbar / Pivotante / Turnable / Girevole / Çevrilebilir

Best.-Nr.  
1724-D

Best.-Nr.  
1725-D

Best.-Nr.  
1727-D

Best.-Nr.  
1728-D

Best.-Nr.  
1729-D

E-mail: bilgi@yapimetal.net, www.yapimetal.net

Telefon: (312) 385 48 06 - Belgegeçer: (312) 385 42 16



87 x 37 x 37 mm

Best.-Nr.  
1710

Massiv / Pleines  
Solid / Massicce / İçi dolu  
Drehbar / Pivotante  
Turnable / Girevole / Çevrilebilir

Paar/Set = 2 x



87 x 37 x 37 mm

Best.-Nr.  
1711



ø 55 mm  
Best.-Nr.  
1750-FU



ø 55 mm  
Best.-Nr.  
1750-PZ



ø 55 mm  
Best.-Nr.  
1750-BB



ø 55 mm  
Best.-Nr.  
1750-B



26 x 65 mm  
Best.-Nr.  
1755-FU



26 x 65 mm  
Best.-Nr.  
1755-PZ



26 x 65 mm  
Best.-Nr.  
1755-BB



26 x 65 mm  
Best.-Nr.  
1755-B

AK INOX

Stossgriffe / Poignées fixes  
Pull handles / Maniglioni / Çekme Kollar

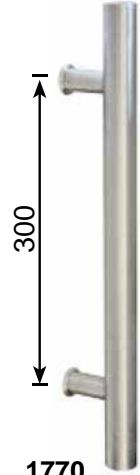

1770  
ø 32 mm

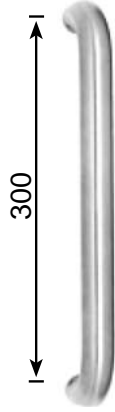

1771  
ø 32 mm

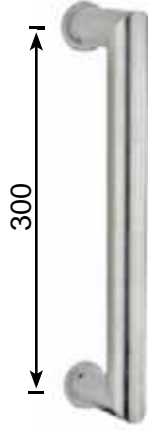

1771-EK  
ø 32 mm

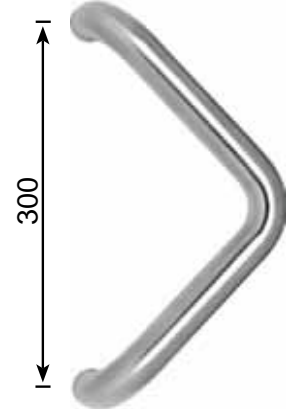

1774  
ø 32 mm

Sonderabmessungen auf Anfrage / Dimensions spéciales sur demande  
Special sizes of products on demand / Misure speciali su richiesta  
Talep üzerine özel ölçülerde üretilebilir

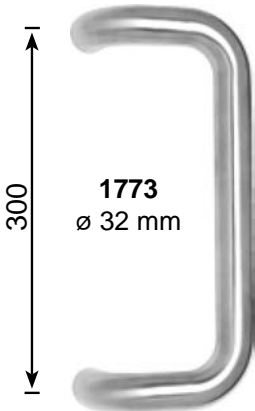

1773  
ø 32 mm

0 1 2 3  
4 5 6  
7 8 9  
a b c d

0,1,2,3,4,5,6,7,8,9  
=150 mm  
a,b,c,d = 115 mm  
Best.-Nr.  
1790

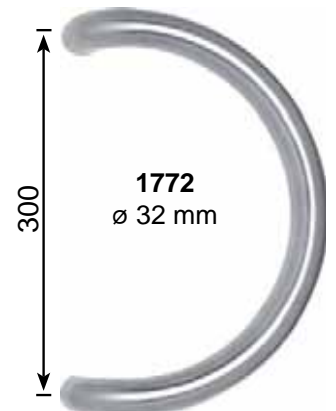

1772  
ø 32 mm

## Drahtseile / Cordages / Wire ropes / Funi / Halat

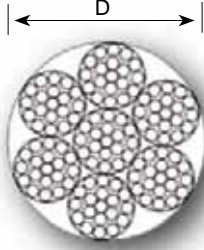

Drahtseil 7x19, 25 m-Rolle  
Cordage 7x19, 25 m-Bobine  
Wire rope 7x19, 25 m-Reel  
Fune 7x19, 25 m-Ruote  
Halat 7x19, 25 m Makara

V2A / Inox 304	
øD /mm	Best.-Nr.
3	1420-3-S 304
4	1420-4-S 304
5	1420-5-S 304

## Ketten / Chaines / Chains / Catene / Zincir



Edelstahl V2A / Inox 304  
Inox 304 / Inox 304  
304 Kalite Paslanmaz Çelik  
DIN 766

V2A / Inox 304	
øD /mm	Best.-Nr.
3	1421-3-304
4	1421-4-304
5	1421-5-304
6	1421-6-304

## Gewindeterminale für Selbmontage

Embout à filetage externe

Self mounting terminal with external thread

Terminali automontanti con filettatura esterna

Saplamalı terminal (setskur sıkıştırılmalı)



Rechtsgewinde Filetage droite Right thread Filetto destro Sağ dişli	øD /mm	øD1 /mm	L /mm	M x l /mm	Best.-Nr.
	2	7,85	50	4x20	1461-8
	3	9,7	56	4x20	1461-10
	4	12	65	5x24	1461-12

Linksgewinde Filetage gauche Left thread Filetto sinistro Sol dişli	øD /mm	øD1 /mm	L /mm	M x l /mm	Best.-Nr.
	2	7,85	50	4x20	1461-8-L
	3	9,7	56	4x20	1461-10-L
	4	12	65	5x24	1461-12-L

## Innengewindeterminale für Selbstmontage

Embout à filetage interne

Self mounting terminal with internal thread

Terminali automontanti con filettatura interna

Yuvalı terminal (setskur sıkıştırılmalı)

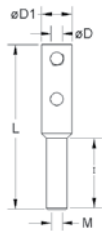

Rechtsgewinde Filetage droite Right thread Filetto destro Sağ dişli	øD /mm	øD1 /mm	L /mm	M x l /mm	Best.-Nr.
	2	8	50	4x20	1460-2
	3	10	56	4x20	1460-3
	4	12	65	5x25	1460-4

Linksgewinde Filetage gauche Left thread Filetto sinistro Sol dişli	øD /mm	øD1 /mm	L /mm	M x l /mm	Best.-Nr.
	2	8	50	4x20	1460-2-L
	3	10	56	4x20	1460-3-L
	4	12	65	5x25	1460-4-L

## Augterminale für Selbstmontage

Embout à chape, fixation interne

Self mounting fork terminal

Terminali a forcilla automontanti

Çatalı terminal (setskur sıkıştırılmalı)

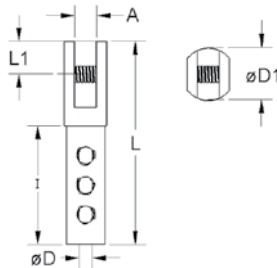

øD /mm	øD1 /mm	L /mm	l /mm	L1 /mm	A /mm	Best.-Nr.
2	10	44	24,5	7,0	4,7	1433-S-2
3	12	57	32,0	7,5	5,0	1433-S-3
4	16	60	35,0	8,0	7,0	1433-S-4

## Gabelterminale für Selbstmontage

Embout à chape avec oeil

Self mounting terminal with eye

Terminali automontanti con occhio

Gözlü terminal (setskur sıkıştırılmalı)

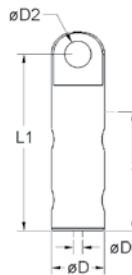

øD /mm	øD1 /mm	øD2 /mm	L1 /mm	l /mm	Best.-Nr.
2	2,4	4,5	37	25	1430-S-2
3	3,5	5,5	43	32	1430-S-3
4	4,5	6,5	52	34	1430-S-4



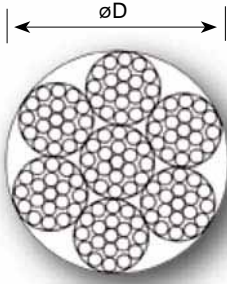

**Bu ürünlerin  
Türkiye'de  
satışı yoktur!**

Drahtseil 7x19, 25 m-Rolle  
 Cordage 7x19, 25 m-Bobine  
 Wire rope 7x19, 25 m-Reel  
 Fune 7x19, 25 m-Ruote  
 Halat 7x19, 25 m Makara

V4A / Inox 316	
øD /mm	Best.-Nr.
3	3420-3
4	3420-4
5	3420-5

Spannhülse / Cage fermée de ridoir  
 Body of turnbuckle / Tenditori corpo / Gerdirme gövdesi



M	Best.-Nr.
M5	3425-5
M6	3425-6
M8	3425-8
M10	3425-10

Gewindeösenterminal / Boulon à oeil  
 Eye bolt / Vite lunga con occhiello / Gözlü saplama

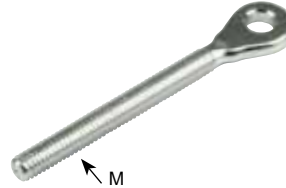

M	Best.-Nr.
M5	3437-5
M6	3437-6
M8	3437-8
M10	3437-10

Spannschloss mit Haken-Öse  
 Ridoir à crochet-oeil / Turnbuckle with Hook-Eye  
 Tenditore uncino-occhiello / Göz-Kanca gerdirme

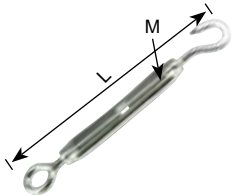

L /mm	M	Best.-Nr.
172-252	M6	3418-HE-6
182-257	M8	3418-HE-8
213-298	M10	3418-HE-10
238-318	M12	3418-HE-12

Gabelterminal / Embout à chape  
 Fork terminal / Terminale a forcella / Çatal terminal



øD /mm	Best.-Nr.
3	3431-3
4	3431-4
5	3431-5
6	3431-6

Spannschloss mit Haken/Haken  
 Ridoir à deux crochets / Turnbuckle with Hook-Hook  
 Tenditore a doppio uncino / Kanca-Kanca gerdirme



L /mm	M	Best.-Nr.
160	M6	3418-HH-6
200	M8	3418-HH-8
240	M10	3418-HH-10
300	M12	3418-HH-12

Spannschloss mit Öse/Öse  
 Ridoir à deux yeux / Turnbuckle with Eye-Eye  
 Tenditore a doppio occhiello / Göz-Göz gerdirme



L /mm	M	Best.-Nr.
160	M6	3418-EE-6
200	M8	3418-EE-8
240	M10	3418-EE-10
300	M12	3418-EE-12

Wantenspanner mit 2 Gabeln  
 Ridoir à chapes fixes / Turnbuckle with two forks  
 Tenditore a doppia forcella / Liftin



L /mm	M	Best.-Nr.
144	M6	3423-6
173	M8	3423-8
207	M10	3423-10
251	M12	3423-12

Gewindeterminal / Piton à sertir  
 Swage stud / Terminale a perno / Saplamalı terminal



M	øD /mm	Best.-Nr.
M6	3	3439-6-3
M6	4	3439-6-4
M8	5	3439-8-5
M10	6	3439-10-6

Gabelterminal / Embout à chape  
 Fork terminal / Terminale a forcella / Çatal terminal



øD /mm	Best.-Nr.
3	3433-3
4	3433-4
5	3433-5
6	3433-6

Gewindegabel / Embout à chape avec filetage externe  
 Fork with external thread / Forcella con filetto esterno / Çatal saplama



øD /mm	Best.-Nr.
M5	3434-5
M6	3434-6
M8	3434-8
M10	3434-10

**Gewindegabel**

Embout à chape avec filetage externe / Fork with external thread  
 Forcella con filetto esterno / Çatal saplama

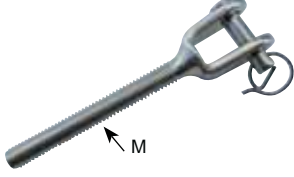

M	Best.-Nr.
M5	3432-5
M6	3432-6
M8	3432-8
M10	3432-10

**Augterminal für Selbmontage**

Embout à chape, fixation interne / Self mounting fork terminal  
 Terminali a forcella automontanti / Çatal terminal (setskur sıkıştırılmalı)



øD /mm	Best.-Nr.
2	3433-S-2
3	3433-S-3
4	3433-S-4

**Augterminal**

Embout à oeil à sertir / Eye bolt terminal  
 Bullone con terminale a occhiello / Gözlü terminal



øD /mm	Best.-Nr.
3	3436-3
4	3436-4
5	3436-5
6	3436-6

**Augbolzen**

Boulon à oeil avec écrou / Eye bolt with cap  
 Vite lunga con occhiello e rondelle / Gözlü saplama (şapkalı)

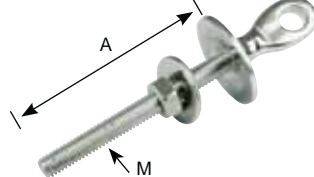

M	A /mm	Best.-Nr.
M6	60	3438-6
M8	80	3438-8

Linsenkopfterminal / Terminaison à tête cylindrique bombée à sertir /  
 Domed head terminal / Terminale a testa cilindrica  
 Kubbe baş terminal



øD /mm	Best.-Nr.
3	3440-3
4	3440-4
5	3440-5
6	3440-6

**Augenschraube / Piton à oeil**

Eye bolt / Terminale a occhiello / Gözlü saplama

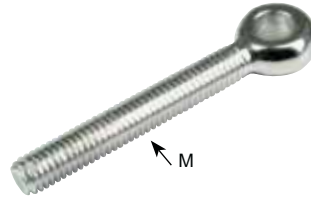

M	Best.-Nr.
M6	3491-2-6
M8	3491-2-8
M10	3491-2-10

**Wantenspanner mit Gabel/Gewinde**

Ridoir à chape fixe, terminaison à sertir  
 Turnbuckle with fork and terminal  
 Tenditore con terminale a forcella / Terminallı liftin

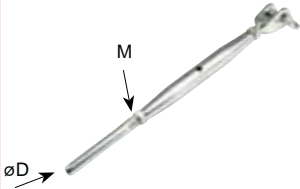

M	øD /mm	Best.-Nr.
M6	3	3424-6
M8	4	3424-8
M10	5	3424-10
M12	6	3424-12

**Augenschraube mit Holzgewinde**

Piton à oeil fermé filetage bois / Eye bolt with wood thread  
 Bullone con occhiello con filetto da legno / Ağaç için gözülü saplama

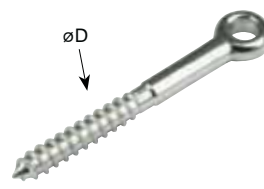

øD /mm	Best.-Nr.
M6	3491-1-6
M8	3491-1-8
M10	3491-1-10

Gabelterminal für Selbmontage / Embout à chape avec oeil  
 Self mounting terminal with eye / Terminali automontanti con occhiello  
 Gözlü terminal (setskur sıkıştırılmalı)



øD /mm	Best.-Nr.
2	3435-4
3	3435-5
4	3435-6
5	3435-8
6	3435-10

Innengewindeterminale für Selbstmontage / Embout à filetage interne  
 Self mounting terminal with internal thread  
 Terminali automontanti con filettatura interna  
 Yuvalı terminal (setskur sıkıştırılmalı)



M	øD /mm	Best.-Nr.
M4	2	3460-2
M4	3	3460-3
M5	4	3460-4

Gewindeterminale für Selbmontage / Embout à filetage externe  
 Self mounting terminal with external thread  
 Terminali automontanti con filettatura esterna  
 Saplamalı terminal (setskur sıkıştırılmalı)



øD /mm	Best.-Nr.
2	3461-8
3	3461-10
4	3461-12

Gabelterminal für Selbmontage / Embout à chape avec oeil  
 Self mounting terminal with eye  
 Terminali automontanti con occhiello  
 Gözlü terminal (setskur sıkıştırılmalı)



øD /mm	Best.-Nr.
2	3430-S-2
3	3430-S-3
4	3430-S-4

**AK** INOX

**Ketten und Zubehör / Chaînes et équipements**  
**Chains and accessories / Catene e accessori / Zincir ve aksesuarları**

**Bu ürünlerin  
Türkiye'de  
satışı yoktur!**

Abbildung in Edelstahl



Edelstahl V4A / Inox 316  
Inox 316 / Inox 316  
316 kalite paslanmaz çelik  
DIN 766

øD /mm	Best.-Nr.
3	3421-3
4	3421-4
5	3421-5
6	3421-6

Stahl verzinkt / Acier zingué  
Galvanized steel / Acciaio zincato  
Galvanizli çelik  
DIN 766

øD /mm	Best.-Nr.
3	1421-Z-3
4	1421-Z-4
5	1421-Z-5
6	1421-Z-6

Schäkel / Manille droite

Shackle (D type) / Grillo (tipo D) / Zincir kilidi (D tipi)



øD /mm	Best.-Nr.
4	3401-4
5	3401-5
6	3401-6
8	3401-8

Flachschäkel (lange Form) / Manille droite plate, longue

Flat shackle (long D type) / Grillo piatto (tipo D lungo)  
Zincir kilidi (uzun düz D tipi)



øD /mm	Best.-Nr.
4	3410-4
5	3410-5
6	3410-6
8	3410-8

Schäkel / Manille lyre

Shackle (omega type) / Grillo (tipo omega) / Zincir kilidi (omega tipi)



øD /mm	Best.-Nr.
4	3402-4
5	3402-5
6	3402-6
8	3402-8

Schlüsselschäkel mit Steg

Manille droite longue avec barette, axe imperdable  
Key-pin shackle with bar / Grillo con chiave a perno con barra  
Anahtarlı zincir kilidi (gözlü D tipi)



øD /mm	Best.-Nr.
5	3411-5
6	3411-6
8	3411-8

Rundschäkel (lange Form) / Manille droite, longue

Shackle (long D type) / Grillo (tipo D lungo) / Zincir kilidi (uzun D tipi)



øD /mm	Best.-Nr.
4	3403-4
5	3403-5
6	3403-6
8	3403-8

Rundschäkel (gedrehte Form) / Manille torse

Shackle (twisted type) / Grillo (tipo arrotolato) / Zincir kilidi (burgulu tip)

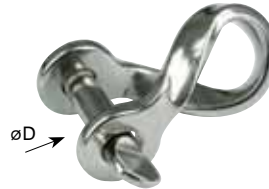

øD /mm	Best.-Nr.
5	3412-5
6	3412-6
8	3412-8

**AK** INOX

V4A / INOX 316

**Klemmbefestigungen / Pinces de vitre**

**Glass clamps / Supporti a clip per vetro / Cam tutucuları**

Seite/ Page

Page / Pagina / Sayfa

12-13





Rundschäkel (gedrehte Form)  
Manille torse / Shackle (twisted type)  
Grillo (tipo arrotolato) / Zincir kilidi (burgulu tip)



øD /mm	Best.-Nr.
4	3404-4
5	3404-5
6	3404-6
8	3404-8

Flachschäkel (lange Form) / Manille droite plate, longue  
Flat shackle (long D type) / Grillo piatto (tipo D lungo)  
Zincir kilidi (uzun düz D tipi)



øD /mm	Best.-Nr.
6	3414-6
8	3414-8

Flachschäkel (geschweifte Form) / Manille lyre plate  
Flat shackle (omega type) / Grillo piatto (tipo omega)  
Zincir kilidi (düz omega tipi)



øD /mm	Best.-Nr.
4	3409-4
5	3409-5
6	3409-6
8	3409-8

Augenschraube mit Ring / Piton à anneau  
Eye bolt with ring / Bullone con anello / Halkalı vida



A /mm	Best.-Nr.
3	3492-3
5	3492-5

Ringmutter / Ecrou à anneau  
Lifting eye nut / Anello filettato / Halkalı somun



M	Best.-Nr.
M6	3489-6
M8	3489-8
M10	3489-10

Seilkausche / Cosse cœur  
Wire thimble / Redancia per fune / Radanza



øD /mm	Best.-Nr.
3	3455-3
4	3455-4
5	3455-5
6	3455-6

Ringschraube / Vis à anneau  
Lifting eye bolt / Vite ad anello / Halkalı civata



M	Best.-Nr.
M6	3490-6
M8	3490-8
M10	3490-10

Simplexklemme / Serre câble plat  
Simplex wire rope clip / Fermacavo piatto / Tekli klemens



øD /mm	Best.-Nr.
3	3448-3
4	3448-4
5	3448-5
6	3448-6

Kettenschnellverschluss / Crochet avec écrou  
Hook with nut / Moschettone con dado / Vida kilitli karabina



øD /mm	Best.-Nr.
4	3482-4
5	3482-5
6	3482-6
8	3482-8

Duplexklemme / Double serre câble plat  
Duplex wire rope clips / Doppio fermacavo piatto / Çiftli klemens



øD /mm	Best.-Nr.
3	3449-3
4	3449-4
5	3449-5
6	3449-6

Karabinerhaken / Mousqueton  
Snap hook / Moschettone / Karabina



D x L /mm	Best.-Nr.
4 x 40	3465-4
5 x 50	3465-5
6 x 60	3465-6
8 x 80	3465-8

Seilklemme / Serre câble à étrier  
Wire rope clip / Fermacavo / Halat klemensi (kerye)



øD /mm	Best.-Nr.
3	3441-3
4	3441-4
5	3441-5
6	3441-6



**Rohrabschlussstopfen, gewölbt**  
Embout de fermeture, bombé  
End cap, cambered  
Coperchio, bombato  
Boru kapağı, Bombeli

Rohr/Tube øD x s / mm	Best.-Nr.
26,9 x 2,0	2004
33,7 x 2,0	2001
33,7 x 2,6	2005
42,4 x 2,0	2002
42,4 x 2,6	2006
48,3 x 2,0	2003
48,3 x 2,6	2007



**Rohrabschlussstopfen, gewölbt mit M8 Gewinde**  
Embout de fermeture, bombé avec filetage M8  
End cap, cambered with M8-thread  
Coperchio, bombato con foro filettato M8  
Boru kapağı, Bombeli M8 Dişli

Rohr/Tube øD x s / mm	Best.-Nr.
26,9 x 2,0	2004-G
33,7 x 2,0	2001-G
33,7 x 2,6	2005-G
42,4 x 2,0	2002-G
42,4 x 2,6	2006-G
48,3 x 2,0	2003-G
48,3 x 2,6	2007-G



**Rohr-Kugelstopfen, mit M8 Gewinde**  
Embout hémisphérique, filetage M8  
Hemisphere end cap, with M8- thread  
Coperchio semisferico, con foro filettato M8  
Yarım küre boru kapağı, M8 Dişli

Rohr/Tube øD x s / mm	Best.-Nr.
26,9 x 2,0	2023-G
33,7 x 2,0	2020-G
33,7 x 2,6	2024-G
42,4 x 2,0	2021-G
42,4 x 2,6	2025-G
48,3 x 2,0	2022-G
48,3 x 2,6	2026-G



**Rohr-Kugelstopfen**  
Embout hémisphérique / Hemisphere end cap  
Coperchio semisferico / Yarım küre boru kapağı

Rohr/Tube øD x s / mm	Best.-Nr.
26,9 x 2,0	2023
33,7 x 2,0	2020
33,7 x 2,6	2024
42,4 x 2,0	2021
42,4 x 2,6	2025
48,3 x 2,0	2022
48,3 x 2,6	2026



**Rohr-Knopf**  
Pommesaux / Knobs / Pomoli / Topuz

Rohr/Tube øD x s / mm	Best.-Nr.
33,7 x 2,0	2036
33,7 x 2,6	2037
42,4 x 2,0	2038
42,4 x 2,6	2039
48,3 x 2,0	2040
48,3 x 2,6	2041



**Rohr-Knopf**  
Pommesaux / Knobs / Pomoli / Topuz

Rohr/Tube øD x s / mm	Best.-Nr.
33,7 x 2,0	2030
33,7 x 2,6	2033
42,4 x 2,0	2031
42,4 x 2,6	2034
48,3 x 2,0	2032
48,3 x 2,6	2035

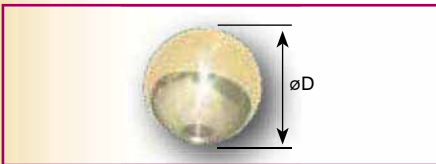

**Hohlkugeln**  
Sphères / Spheres / Sfere / Küre

øD / mm	M	Best.-Nr.
20	M6	2626-G
25	M6	2627-G
30	M6	2628-G
35	M6	2629-G



**Hohlkugeln, mit Gewinde**  
Sphères, avec pas de vis / Spheres, with screw hole  
Sfere, con foro filettato / Küre, tek tarafı dişli

øD / mm	M	Best.-Nr.
60	M8	2605-G
70	M8	2606-G
80	M10	2607-G
90	M10	2608-G
100	M10	2609-G
120	M10	2610-G
150	M12	2611-G
200	M12	2612-G



**Rohr-Abschlusskugeln**  
Embout sphérique / Sphere end cap  
Coperchio a sfera / Küre boru kapağı

øB / mm	øD / mm	Best.-Nr.
26,9	40	2050
33,7	45	2051
42,4	55	2052
48,3	60	2053



**Rohranschlussplatten gewölbt**  
Platines de fixation concaves  
Concave montage plates  
Placche per fissaggio concave  
Bombeli küpeşte montaj tablaları

	Für Rohr-ø		Best.-Nr.
	33,7 mm	42,4 mm	
65 x 25 x 3,0	33,7 mm	42,4 mm	2280
	42,4 mm	48,3 mm	2281
	48,3 mm		2282
80 x 25 x 3,0	33,7 mm	42,4 mm	2283
	42,4 mm	48,3 mm	2284
	48,3 mm		2285

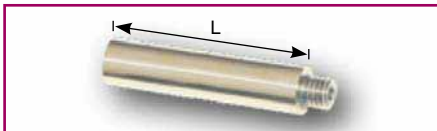

**Montagestifte**  
Rallonge / Extension bar  
Barra - prolunga / Montaj çubuğu

L/mm	Best.-Nr.
65	2292
100	2293



**Stanzteile / Platines / Plates / Placche / Pullar**

øD x s / mm	Best.-Nr.
40x4	2101
50x4	2102
60x4	2103
70x4	2104
80x4	2106
100x4	2108

## AK BRASS

### Abdeckrosetten / Rosaces / Cover plates / Copriflange / Rozetler

				
<b>ø 75x12 mm</b>	<b>ø 75x22 mm</b>	<b>ø 85x12 mm</b>	<b>ø 85x22 mm</b>	<b>ø 105x22 mm</b>
<b>øB /mm</b>	<b>øB /mm</b>	<b>øB /mm</b>	<b>øB /mm</b>	<b>øB /mm</b>
<b>Best.-Nr.</b>	<b>Best.-Nr.</b>	<b>Best.-Nr.</b>	<b>Best.-Nr.</b>	<b>Best.-Nr.</b>
12,5 <b>2206-12</b>	12,5 <b>2210-12</b>	12,5 <b>2218-12</b>	12,5 <b>2219-12</b>	34,0 <b>2216-34</b>
14,5 <b>2206-14</b>	14,5 <b>2210-14</b>	14,5 <b>2218-14</b>	14,5 <b>2219-14</b>	43,0 <b>2216-43</b>
34,0 <b>2206-34</b>	34,0 <b>2210-34</b>	34,0 <b>2218-34</b>	34,0 <b>2219-34</b>	49,0 <b>2216-49</b>
				
<b>ø 105x22 mm</b>	<b>ø 75x24 mm</b>	<b>ø 85x24mm</b>	<b>ø 105x38 mm</b>	<b>ø 125x38 mm</b>
<b>øB /mm</b>	<b>øB /mm</b>	<b>øB /mm</b>	<b>øB /mm</b>	<b>øB /mm</b>
<b>Best.-Nr.</b>	<b>Best.-Nr.</b>	<b>Best.-Nr.</b>	<b>Best.-Nr.</b>	<b>Best.-Nr.</b>
43,0 <b>2217-43</b>	12,5 <b>2201-12</b>	12,5 <b>2202-12</b>	34,0 <b>2203-34</b>	43,0 <b>2204-43</b>
49,0 <b>2217-49</b>	14,5 <b>2201-14</b>	14,5 <b>2202-14</b>	43,0 <b>2203-43</b>	49,0 <b>2204-49</b>
	34,0 <b>2201-34</b>	34,0 <b>2202-34</b>	49,0 <b>2203-49</b>	

## AK BRASS

### Handlaufzubehör / Accessoires de main-courantes Handrail accessories / Accessori per corrimano / Küpeşte aksesuarları

				
75 x 75 mm aus ø12 mm, mit M6 Innengewinde, Ronde 70x4 mm mit 9 mm Bohrungen angesenkt.	75 x 75 mm aus ø12 mm, mit M8 Aussengewinde, Ronde 70x4 mm mit 9 mm Bohrungen angesenkt.	<b>verstellbar</b> 75 x 75 mm aus ø12 mm Ronde 70x4 mm	Träger mit Abschlusskugel Schenkel 40 mm aus ø12 mm, Ronde 70x4 mm, mit 9 mm Bohrungen Passend für Rohr	Träger mit Durchgangsloch Schenkel 40 mm aus ø12 mm, Ronde 70x4 mm, mit 9 mm Bohrungen Passend für Rohr
<b>Best.-Nr.</b> 2221	<b>Best.-Nr.</b> 2222	<b>Best.-Nr.</b> 2231		

Zoll	øB /mm	<b>Best.-Nr.</b>	Zoll	øB /mm	<b>Best.-Nr.</b>
1"	33,7	<b>2250</b>	1"	33,7	<b>2252</b>
1 ¼"	42,4	<b>2251</b>	1 ¼"	42,4	<b>2253</b>

## AK BRASS

### Zierteile / Accessoires / Accessories / Accessori / Aksesuarlar

<b>øB /mm</b>	<b>Best.-Nr.</b>		<b>øB /mm</b>	<b>Best.-Nr.</b>
10,2	<b>2980-10</b>		10,2	<b>2983-10</b>
12,2	<b>2980-12</b>		12,2	<b>2983-12</b>
14,2	<b>2980-14</b>		14,2	<b>2983-14</b>
10,2	<b>2981-10</b>		10,2	<b>2984-10</b>
12,2	<b>2981-12</b>		12,2	<b>2984-12</b>
14,2	<b>2981-14</b>	14,2	<b>2984-14</b>	
10,2	<b>2986-10</b>		10,2	<b>2985-10</b>
12,2	<b>2986-12</b>		12,2	<b>2985-12</b>
14,2	<b>2986-14</b>		14,2	<b>2985-14</b>



**Ankerplatten / Platines de fixation**  
**Anchor plates / Placche per fissaggio / Montaj tablaları**

B x H x s /mm	Best.-Nr.	Paket/Stk/paquet
100 x 50 x 6	<b>10980</b>	<b>135</b>
120 x 60 x 6	<b>10981</b>	<b>100</b>
120 x 60 x 8	<b>10982</b>	<b>75</b>
120 x 80 x 6	<b>10983</b>	<b>80</b>
120 x 80 x 8	<b>10984</b>	<b>60</b>
100 x 100 x 6	<b>10985</b>	<b>65</b>
100 x 100 x 8	<b>10986</b>	<b>50</b>
120 x 120 x 6	<b>10987</b>	<b>44</b>
120 x 120 x 8	<b>10988</b>	<b>36</b>
150 x 100 x 8	<b>10989-150</b>	<b>32</b>
200 x 125 x 8	<b>10989-200</b>	<b>20</b>

øD x s /mm	Best.-Nr.	Paket/Stk/pcs
27 x 3	<b>10948</b>	<b>100</b>
30 x 4	<b>10947</b>	<b>100</b>
33 x 4	<b>10930</b>	<b>100</b>
42 x 4	<b>10931</b>	<b>100</b>
48 x 4	<b>10932</b>	<b>100</b>
60 x 4	<b>10933</b>	<b>100</b>
70 x 4	<b>10934</b>	<b>100</b>
70 x 6	<b>10935</b>	<b>100</b>
80 x 4	<b>10936</b>	<b>100</b>
80 x 6	<b>10937</b>	<b>100</b>

øD x s /mm	Best.-Nr.	Paket/Stk/paquet
80 x 8	<b>10938</b>	<b>100</b>
100 x 4	<b>10939</b>	<b>100</b>
100 x 6	<b>10940</b>	<b>80</b>
100 x 8	<b>10941</b>	<b>60</b>
120 x 4	<b>10942</b>	<b>80</b>
120 x 6	<b>10943</b>	<b>55</b>
120 x 8	<b>10944</b>	<b>45</b>
150 x 6	<b>10945</b>	<b>35</b>
150 x 8	<b>10946</b>	<b>27</b>

øD x s /mm	Best.-Nr.	Paket/Stk/paquet
80 x 6	<b>10912</b>	<b>100</b>
80 x 8	<b>10913</b>	<b>100</b>
100 x 6	<b>10914</b>	<b>85</b>
100 x 8	<b>10915</b>	<b>65</b>
120 x 6	<b>10916</b>	<b>60</b>
120 x 8	<b>10917</b>	<b>50</b>

øD x s /mm	Best.-Nr.	Paket/Stk/paquet
100 x 100 x 8	<b>10986-OB</b>	<b>50</b>
120 x 80 x 8	<b>10984-OB</b>	<b>60</b>
120 x 120 x 8	<b>10988-OB</b>	<b>36</b>
150 x 100 x 8	<b>10989-150-OB</b>	<b>32</b>
200 x 125 x 8	<b>10989-200-OB</b>	<b>20</b>

øD x s /mm	Best.-Nr.	Paket/Stk/paquet
70 x 6	<b>10920</b>	<b>100</b>
80 x 6	<b>10921</b>	<b>100</b>
80 x 8	<b>10922</b>	<b>100</b>
100 x 6	<b>10923</b>	<b>85</b>
100 x 8	<b>10924</b>	<b>65</b>
120 x 6	<b>10925</b>	<b>60</b>
120 x 8	<b>10926</b>	<b>45</b>
150 x 6	<b>10927</b>	<b>35</b>
150 x 8	<b>10928</b>	<b>28</b>

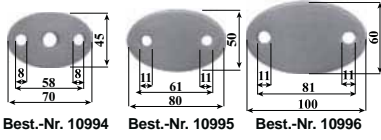

B x H x s /mm	Best.-Nr.
70 x 45 x 6	<b>10994</b>
80 x 50 x 6	<b>10995</b>
100 x 60 x 6	<b>10996</b>

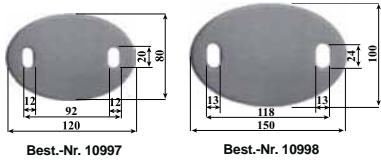

B x H x s /mm	Best.-Nr.
120 x 80 x 6	<b>10997</b>
150 x 100 x 6	<b>10998</b>

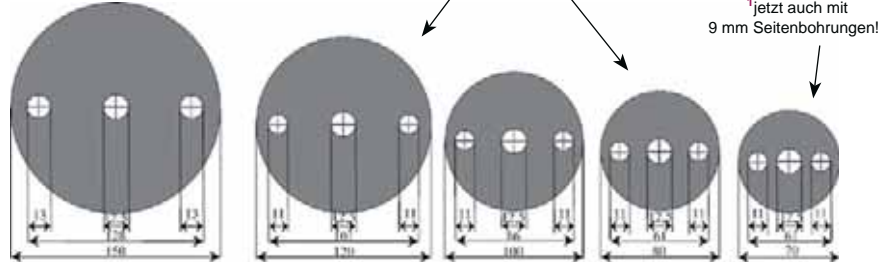
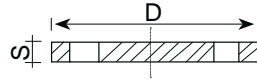

<sup>1</sup> Seitenbohrungen / Troux latéraux  
Edge holes / Adesso con foro / Kenar delikleri : 9 mm

<sup>2</sup> Seitenbohrungen / Troux latéraux  
Edge holes / Adesso con foro / Kenar delikleri : 13 mm

øD x s /mm	Best.-Nr.	Paket/Stk /paquet
70 x 6	<b>10909<sup>1</sup></b>	<b>100</b>
70 x 6	<b>10900</b>	<b>100</b>
80 x 6	<b>10901</b>	<b>100</b>
80 x 8	<b>10903</b>	<b>100</b>
100 x 6	<b>10902</b>	<b>85</b>
100 x 8	<b>10904</b>	<b>65</b>

øD x s /mm	Best.-Nr.	Paket/Stk /paquet
100 x 8	<b>10910<sup>2</sup></b>	<b>65</b>
120 x 6	<b>10905</b>	<b>60</b>
120 x 8	<b>10906</b>	<b>45</b>
120 x 8	<b>10911<sup>2</sup></b>	<b>45</b>
150 x 6	<b>10907</b>	<b>35</b>
150 x 8	<b>10908</b>	<b>28</b>

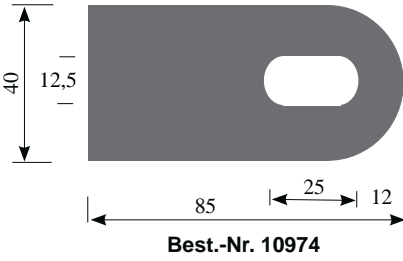

Best.-Nr. 10974

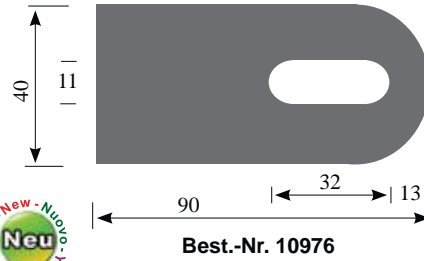

Best.-Nr. 10976

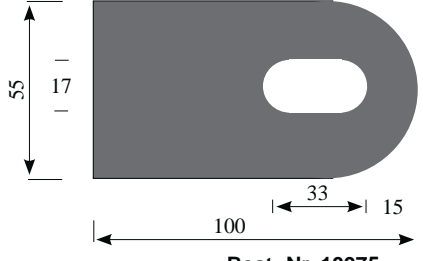

Best.-Nr. 10975

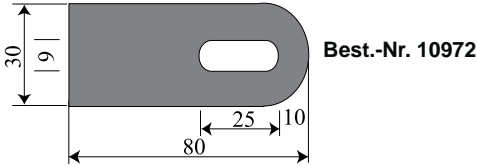

Best.-Nr. 10972

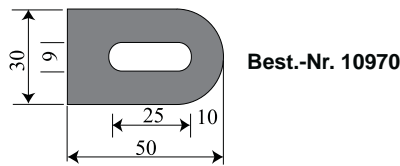

Best.-Nr. 10970

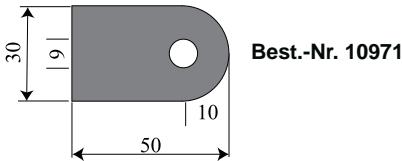

Best.-Nr. 10971

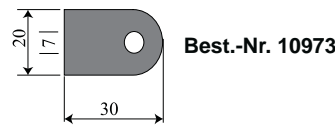

Best.-Nr. 10973

B x H x s /mm	Best.-Nr.
30 x 20 x 4	<b>10973</b>
50 x 30 x 6	<b>10970</b>
50 x 30 x 6	<b>10971</b>
80 x 30 x 6	<b>10972</b>
85 x 40 x 8	<b>10974</b>
90 x 40 x 8	<b>10976</b>
100 x 55 x 8	<b>10975</b>

**Wandbefestigung / Articles de fixation**

**Side mounted bases / Supporti da parete / Duvar montaj elemanları**



øB /mm	s /mm	Best.-Nr.
33,7	6	<b>10890-33</b>
42,4	6	<b>10890-42</b>
48,3	6	<b>10890-48</b>



A /mm	B /mm	s /mm	Best.-Nr.
30	30	6	<b>10891-30</b>
40	40	6	<b>10891-40</b>

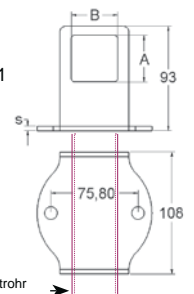
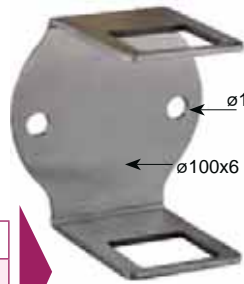

Vierkantrohr  
Rectangle tube



Material 2,5 mm  
**Rohrabschlussstopfen, gewölbt**  
**Embout de fermeture, Bombé / End cap, Cambered**  
**Coperchio, Bombato / Boru kapağı, Bombeli**

øD x s /mm	Best.-Nr.
26,9 x 2,0	12806
33,7 x 2,0	12800
33,7 x 2,6	12801
42,4 x 2,0	12802
42,4 x 2,6	12803
48,3 x 2,0	12804
48,3 x 2,6	12805
60,3 x 2,0	12807



Material 2,5 mm  
**Rohrabschlussstopfen, flach**  
**Embout de fermeture, Plat / End cap, Flat**  
**Coperchio, Piatto / Boru kapağı, Düz**

øD x s /mm	Best.-Nr.
26,9 x 2,0	12826
33,7 x 2,0	12820
33,7 x 2,6	12821
42,4 x 2,0	12822
42,4 x 2,6	12823
48,3 x 2,0	12824
48,3 x 2,6	12825
60,3 x 2,0	12827



Material 4 mm  
**Rohr-Kugelstopfen**  
**Embout hémisphérique / Hemisphere end cap**  
**Coperchio semisferico / Yarım küre boru kapağı**

øD x s /mm	Best.-Nr.
33,7 x 2,0	12840
33,7 x 2,6	12841
42,4 x 2,0	12842
42,4 x 2,6	12843
48,3 x 2,0	12844
48,3 x 2,6	12845



**Rohrabschlussstopfen, gewölbt mit M8 Gewinde**  
**Embout de fermeture, Bombé avec filetage M8**  
**End cap, Cambered with M8-thread**  
**Coperchio, Coperchio bombato con foro filettato M8**  
**Boru kapağı, Bombeli M8 Dişli**

øD x s /mm	Best.-Nr.
26,9 x 2,0	12816-G
33,7 x 2,0	12810-G
33,7 x 2,6	12811-G
42,4 x 2,0	12812-G
42,4 x 2,6	12813-G
48,3 x 2,0	12814-G
48,3 x 2,6	12815-G
60,3 x 2,0	12817-G



**Rohrabschlussstopfen, flach mit M8 Gewinde**  
**Embout de fermeture, Plat, filetage M8**  
**End cap, Flat, with M8-thread**  
**Coperchio, Piatto, con foro filettato M8**  
**Boru kapağı, Düz M8 Dişli**

øD x s /mm	Best.-Nr.
26,9 x 2,0	12836-G
33,7 x 2,0	12830-G
33,7 x 2,6	12831-G
42,4 x 2,0	12832-G
42,4 x 2,6	12833-G
48,3 x 2,0	12834-G
48,3 x 2,6	12835-G
60,3 x 2,0	12837-G

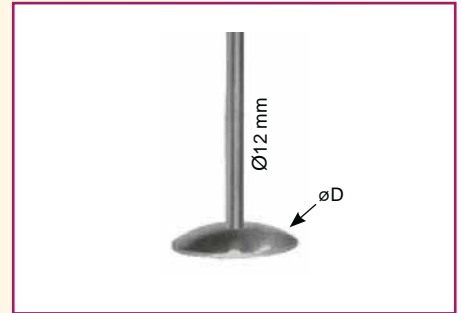

**Handlaufstütze / Support cavalier de main-courante**  
**Floor mounted base**  
**Supporto per tubo da pavimento / Montaj ayağı**

øD x s /mm	Best.-Nr.
33,7	12990
42,4	12991
48,3	12992
60,3	12993

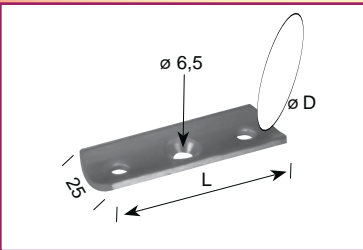

øD /mm	L /mm	Best.-Nr.
33,7	65	12980
42,4	65	12981
48,3	65	12982
33,7	80	12983
42,4	80	12984
48,3	80	12985



**Handlaufträger mit 2-Loch**  
**Supports de main-courante avec deux trous**  
**Handrail brackets with two holes**  
**Supporti per corrimano con due fori**  
**Kolçak, 2 delikli**

øD x s /mm	øB /mm	Best.-Nr.
70 x 6 mm	9	10990
80 x 6 mm	9	10992
70 x 6 mm	11	10991
80 x 6 mm	11	10993

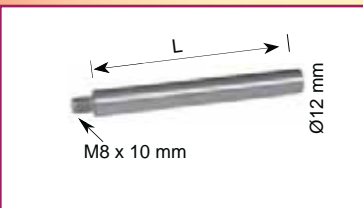

L /mm	Best.-Nr.
65	12995
100	12996

**Abdeckrosetten / Rosaces**  
**Cover plates / Copriflange / Rozetler**

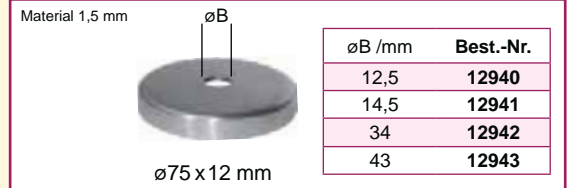

øB /mm	Best.-Nr.
12,5	12940
14,5	12941
34	12942
43	12943



øB /mm	Best.-Nr.
12,5	12936
14,5	12937
34	12938
43	12939

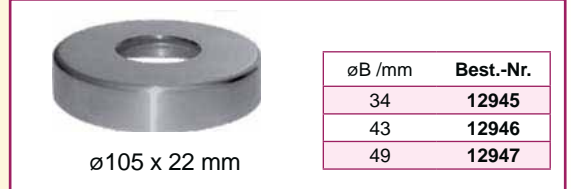

øB /mm	Best.-Nr.
34	12945
43	12946
49	12947



øB /mm	Best.-Nr.
43	12948
49	12949





Material 2 mm

Hohlkugeln  
Sphères / Spheres / Sfere / Küre

øD /mm	Best.-Nr.
30	12508
40	12501
50	12502
60	12503
70	12505
80	12504
90	12506
100	12507
120	12509
150	12510
200	12511



Vollkugeln  
Sphère pleine / Solid ball / Sfere / Dolu Küre

øD /mm	Best.-Nr.
15	12540
20	12541
25	12542
30	12543
35	12544
40	12546
50	12547



Vollkugel mit Durchgangsbohrung 12,5 mm  
Sphère pleine troué taille - à calibre 12,5 mm

Solid ball with 12,5 mm hole

Sfera solida con foro 12,5 mm

Dolu küre - 12,5 mm çap delikli

øD /mm	Best.-Nr.
25	12545-25
30	12545-30
35	12545-35

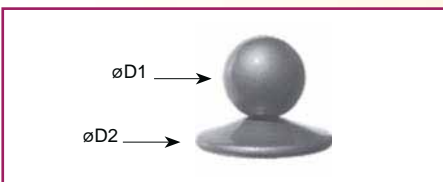

Rohr-Knopf  
Pommeaux / Knobs / Pomoli / Topuz

øD2 /mm	øD1 /mm	Best.-Nr.
42	30	12950
48	40	12951
60	50	12952

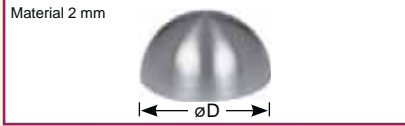

Halbhohlkugeln / Demi-sphère  
Hemisphere / Semisfera / Yarım küre

øD /mm	Best.-Nr.
26,9	12516
30	12520
33,7	12517
40	12521
42,4	12518
48,3	12519
50	12522
60	12523
70	12525
80	12524
90	12526
100	12527
120	12528
150	12529
200	12530



Schweissbogen / Coude  
Elbow / Raccordo a gomito / Patent Dirsek

øD x s /mm	Best.-Nr.
26,9 x 2,0	12997-26
33,7 x 2,6	12997-33
42,4 x 2,6	12997-42
48,3 x 2,6	12997-48
60,3 x 2,6	12997-60

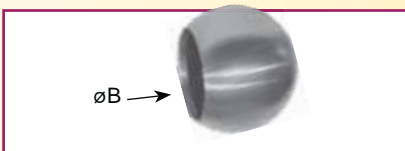

Rohr-Abschlusskugeln / Embout sphérique  
Sphere end cap / Coperchio a sfera  
Küre boru kapağı

øB /mm	Zoll	øD /mm	Best.-Nr.
26,9	¾"	40	12550
33,7	1"	45	12551
42,4	1¼"	55	12552
48,3	1½"	60	12553



Vollkugeln mit Sackloch  
Embout sphérique / Spheres, with blind hole  
Sfera, con foro cieco / Dolu küre, kör delikli

øD /mm	Best.-Nr.
25	12548-25
30	12548-30

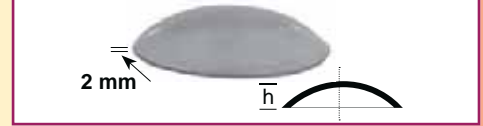

Schale gewölbt / Fermeture bombé  
Domed cap / Coperchio bombato / Bombeli kapak

øD /mm	h /mm	Rohr-Tube /Zoll	Best.-Nr.
21	6	½"	10953
26,9	7	¾"	10954
33	8	1"	10960
42	9	1¼"	10961
48	10	1½"	10962
52	10	1¾"	10955
60	11	2"	10963
70	11	2¼"	10964
76	11	2½"	10956
89	12	3"	10957
100	12	3½"	10965
113	13	4"	10958
120	13	4½"	10959

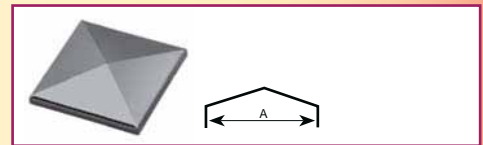

Abdeckkappen  
Embouts pyramidaux / Angular caps  
Coperchi quadrati ad angolo / Dört köşe kapak

A /mm	Best.-Nr.
20 x 20	12900
20 x 30	12901
20 x 40	12902
30 x 30	12903
30 x 50	12905
40 x 40	12906
40 x 60	12907
50 x 50	12908
60 x 60	12909
80 x 80	12910
100 x 100	12911
120 x 120	12912
150 x 150	12913



Runde Abdeckkappen / Fermeture ronde  
Round cap / Coperchio rotondo  
Yuvarlak kaynak kapak

øD /mm	Best.-Nr.
33	12920
42	12921
48	12922
60	12923
101	12924

**AK FER**

**Schnörkel / Volutes**  
**Scrolls / Arrotolata / Motifler**



**Best.-Nr.6000**  
80 x 50 mm, 0,13 kg



**Best.-Nr. 6036**  
60 x 120 mm, 0,15 kg



**Best.-Nr. 6078**  
95 x 135 mm, 0,22 kg



**Best.-Nr. 6001**  
100 x 65 mm, 0,15 kg



**Best.-Nr. 6005**  
80 x 170 mm, 0,23 kg



**Best.-Nr. 6006**  
140 x 190 mm, 0,33 kg



**Best.-Nr. 6002**  
120 x 70 mm, 0,17 kg



**Best.-Nr. 6085**  
110 x 240 mm, 0,33 kg



**Best.-Nr. 6007**  
100 x 150 mm, 0,22 kg



**Best.-Nr. 6031**  
140 x 80 mm, 0,20 kg



**Best.-Nr. 6072**  
120 x 260 mm, 0,44 kg



**Best.-Nr. 6010**  
100 x 50 mm, 0,14 kg



**Best.-Nr. 6003**  
160 x 90 mm, 0,23 kg



**Best.-Nr. 6009**  
130 x 330 mm, 0,41 kg



**Best.-Nr. 6037**  
60 x 220 mm, 0,19 kg



**Best.-Nr. 6032**  
180 x 100 mm, 0,25 kg



**Best.-Nr. 6008**  
75 x 210 mm, 0,23 kg



**Best.-Nr. 6004**  
220 x 120 mm, 0,34 kg



**Best.-Nr. 6071**  
140 x 330 mm, 0,58 kg



**Best.-Nr. 6038**  
60 x 220 mm, 0,21 kg



**Best.-Nr. 6035**  
60 x 120 mm, 0,12 kg



**Best.-Nr. 6012**  
80 x 160 mm, 0,16 kg



**Best.-Nr. 6033**  
260 x 70 mm, 0,29 kg



**Best.-Nr. 6011**  
80 x 80 mm, 0,12 kg



**Best.-Nr. 6230**  
120 x 80 mm, 0,20 kg



**Best.-Nr. 6034**  
270 x 75 mm, 0,29 kg

**AK FER**

**Schnörkel - kantengehämmt / Volutes martelées**  
**Scrolls - hammered edges / Motivo - Bordi martellati / Motifler-Köşe dövme**



Best.-Nr. 6100  
80 x 50 mm, 0,13 kg



Best.-Nr. 6136  
60 x 120 mm, 0,15 kg

Best.-Nr. 6178  
95 x 135 mm, 0,21 kg



Best.-Nr. 6101  
100 x 60 mm, 0,15 kg

Best.-Nr. 6105  
80 x 170 mm, 0,22 kg

Best.-Nr. 6106  
140 x 190 mm, 0,32 kg



Best.-Nr. 6102  
120 x 70 mm, 0,16 kg

Best.-Nr. 6172  
120 x 260 mm, 0,42 kg

Best.-Nr. 6107  
100 x 150 mm, 0,21 kg



Best.-Nr. 6131  
140 x 80 mm, 0,19 kg

Best.-Nr. 6185  
110 x 240 mm, 0,32 kg

Best.-Nr. 6135  
60 x 120 mm, 0,12 kg



Best.-Nr. 6103  
160 x 90 mm, 0,22 kg

Best.-Nr. 6109  
130 x 330 mm, 0,39 kg

Best.-Nr. 6137  
60 x 220 mm, 0,18 kg



Best.-Nr. 6132  
180 x 100 mm, 0,24 kg



Best.-Nr. 6108  
75 x 210 mm, 0,22 kg



Best.-Nr. 6104  
220 x 120 mm, 0,33 kg

Best.-Nr. 6171  
140 x 330 mm, 0,55 kg

Best.-Nr. 6138  
60 x 220 mm, 0,20 kg



Best.-Nr. 6130  
120 x 80 mm, 0,18 kg

Best.-Nr. 6111  
80 x 80 mm, 0,12 kg

Best.-Nr. 6134  
270 x 75 mm, 0,28 kg



Best.-Nr. 6110  
100 x 50 mm, 0,14 kg

Best.-Nr. 6112  
80 x 160 mm, 0,16 kg



Best.-Nr. 6133  
260 x 70 mm, 0,28 kg



**AK FER**

**Leichtbarock-Schnörkel / Volutes - Baroque Léger**  
**Light Baroque scrolls / Motivo Barocco Leggero / Hafif Barok motifler**



**Best.-Nr. 6201**  
120 x 80 mm, 0,20 kg



**Best.-Nr. 6224** **Best.-Nr. 6225**

80 x 80 mm  
0,12 kg



**Best.-Nr. 6202**  
140 x 90 mm, 0,22 kg



**Best.-Nr. 6226** **Best.-Nr. 6227**

80 x 160 mm  
0,17 kg



**Best.-Nr. 6203**  
160 x 90 mm, 0,24 kg



**Best.-Nr. 6220** **Best.-Nr. 6221**

85 x 125 mm  
0,15 kg



**Best.-Nr. 6205**  
220 x 130 mm, 0,33 kg



**Best.-Nr. 6222** **Best.-Nr. 6223**

105 x 150 mm  
0,15 kg



**Best.-Nr. 6260**  
300 x 220 mm  
0,62 kg

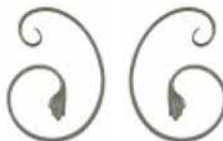

**Best.-Nr. 6238** **Best.-Nr. 6239**

140 x 190 mm  
0,34 kg



70 x 190 mm  
0,22 kg

**Best.-Nr. 6246** **Best.-Nr. 6247**

**AK FER**



**Best.-Nr. 6240** **Best.-Nr. 6241**

80 x 170 mm  
0,23 kg



55 x 260 mm  
0,20 kg

**Best.-Nr. 6231** **Best.-Nr. 6232**



105 x 180 mm  
0,26 kg

**Best.-Nr. 6236** **Best.-Nr. 6237**



**Best.-Nr. 6244** **Best.-Nr. 6245**

140 x 330 mm  
0,41 kg



**Best.-Nr. 6261**  
440 x 350 mm, 0,91 kg



**Best.-Nr. 6254**

200 x 320 mm, 0,50 kg



**Best.-Nr. 6255**



280 x 500 mm, 0,73 kg

**Best.-Nr. 6248**

**Best.-Nr. 6249**

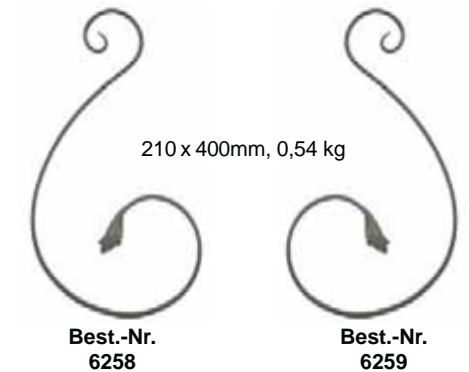

210 x 400mm, 0,54 kg

**Best.-Nr. 6258**

**Best.-Nr. 6259**

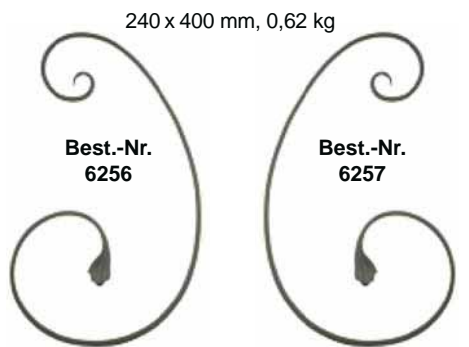

240 x 400 mm, 0,62 kg

**Best.-Nr. 6256**

**Best.-Nr. 6257**

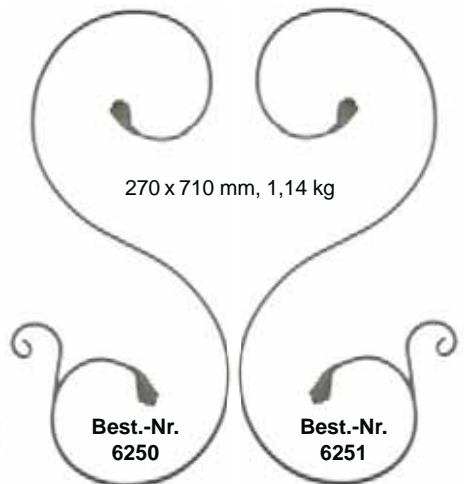

270 x 710 mm, 1,14 kg

**Best.-Nr. 6250**

**Best.-Nr. 6251**

## Landbarock-Schnörkel / Volutes - Baroque de Pays Country Baroque Scrolls / Motivo Barocco Rustico / Kırsal Barok motifler

Best.-Nr.  
14323



210 x 400 mm, 0,83 kg

Best.-Nr.  
14324



Best.-Nr. 14300  
120 x 70 mm, 0,27 kg



Best.-Nr.  
14313

200 x 320 mm, 0,77 kg



Best.-Nr.  
14314

AK FER

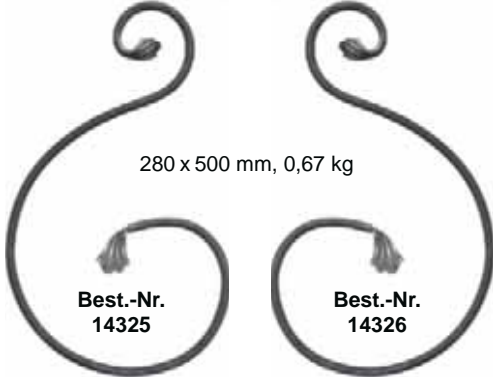

280 x 500 mm, 0,67 kg

Best.-Nr.  
14325

Best.-Nr.  
14326

Best.-Nr. 14302  
160 x 90 mm, 0,32 kg



Best.-Nr.  
14315

240 x 400 mm, 0,97 kg



Best.-Nr.  
14316



Best.-Nr. 14329  
300 x 220 mm, 0,96 kg



Best.-Nr. 14304  
220 x 130 mm, 0,50 kg



Best.-Nr. 14334  
350 x 90 mm, 0,50 kg



Best.-Nr. 14330  
440 x 350 mm, 1,55 kg

AK FER

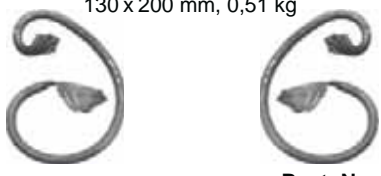

130 x 200 mm, 0,51 kg

Best.-Nr.  
14311

Best.-Nr.  
14312

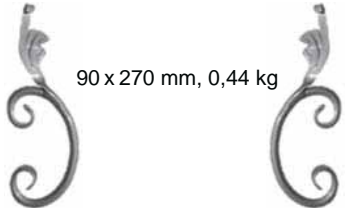

90 x 270 mm, 0,44 kg

Best.-Nr.  
14333

Best.-Nr.  
14332

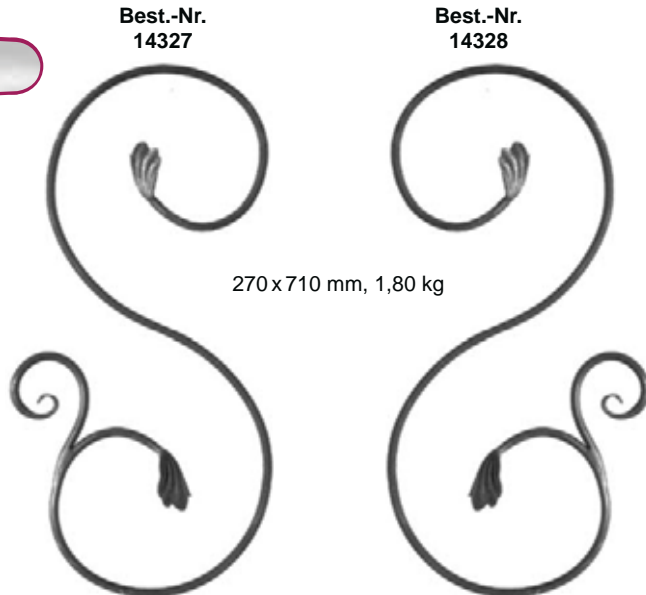

Best.-Nr.  
14327

Best.-Nr.  
14328

270 x 710 mm, 1,80 kg



Detail Ausschmiedung: Blätter aus einem Stück geschmiedet

Patte d'oie. Finition sans soudure forgée à même la pièce

Forge Detail: leaves are forged from one piece of iron without welding

Dettagli di fabbricazione: prodotti forgiati da pezzi interi di ferro, senza alcuna saldatura

Yapraklar kaynaklı olup tek parçadan dövülmüştür

**AK FER**

**Meisterbarock-Schnörkel / Volutes - Baroque de Maître**  
**Master Baroque Scrolls / Motivo Artigianale Barocco / Uzman Barok motifler**



Best.-Nr. 14129  
300 x 220 mm, 1,30 kg

130 x 200 mm, 0,57 kg

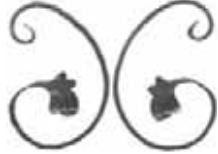

Best.-Nr. 14111

**AK FER**

210 x 400 mm, 0,88 kg



Best.-Nr. 14123

Best.-Nr. 14124

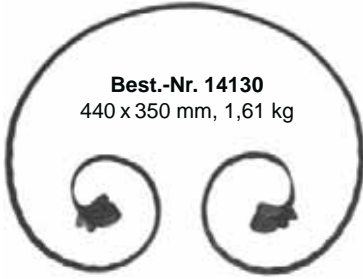

Best.-Nr. 14130  
440 x 350 mm, 1,61 kg

200 x 320 mm, 0,84 kg



Best.-Nr. 14113

Best.-Nr. 14114

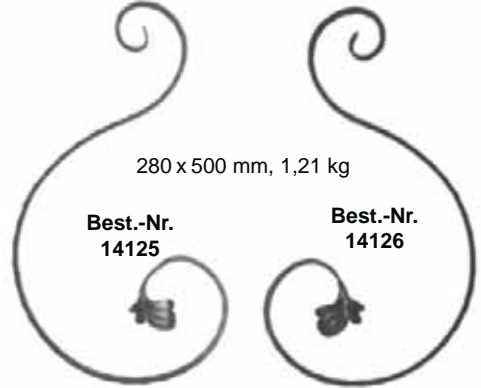

280 x 500 mm, 1,21 kg

Best.-Nr. 14125

Best.-Nr. 14126

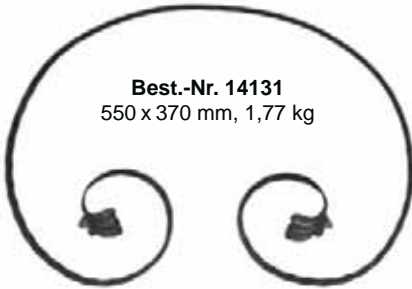

Best.-Nr. 14131  
550 x 370 mm, 1,77 kg

240 x 400 mm, 1,07 kg



Best.-Nr. 14115

Best.-Nr. 14116

140 x 420 mm, 0,80 kg



Best.-Nr. 14121

Best.-Nr. 14122



Best.-Nr. 14100  
120 x 70 mm, 0,26 kg



Best.-Nr. 14102  
160 x 90 mm, 0,39 kg



Best.-Nr. 14104  
220 x 130 mm, 0,55 kg



Best.-Nr. 14110  
130 x 200 mm, 0,54 kg



Best.-Nr. 14107  
140 x 330 mm, 0,81 kg

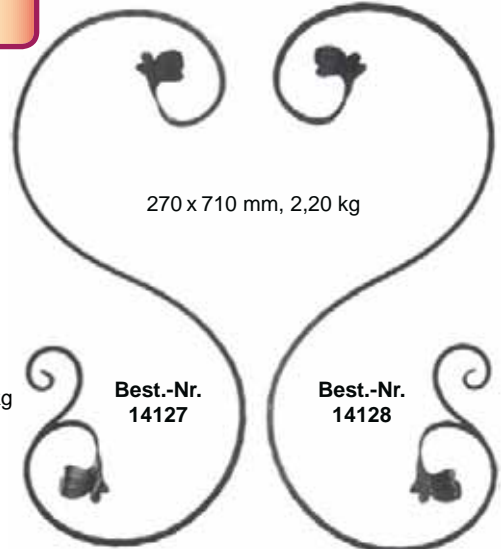

270 x 710 mm, 2,20 kg

Best.-Nr. 14127

Best.-Nr. 14128

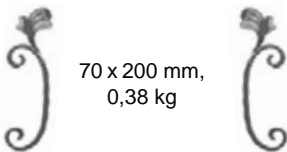

Best.-Nr. 14132

Best.-Nr. 14133

Best.-Nr. 14108  
100 x 160 mm, 0,40 kg



**AK FER**

**Schwerbarock-Schnörkel / Volutes - Baroque Lourde**  
**Heavy Baroque Scrolls / Motivo Barocco Rigido / Ağır Barok Motifler**

130 x 200 mm, 0,50 kg



Best.-Nr.  
14212



Best.-Nr.  
14211



Best.-Nr. 14200  
120 x 70 mm, 0,26 kg



Best.-Nr. 14202  
160 x 90 mm, 0,37 kg



Best.-Nr. 14207  
140 x 330 mm, 0,89 kg



Best.-Nr. 14229  
300 x 220 mm, 1,20 kg

200 x 320 mm, 0,84 kg



Best.-Nr.  
14213



Best.-Nr.  
14214



Best.-Nr. 14204  
220 x 130 mm, 0,55 kg



Best.-Nr. 14210  
130 x 200 mm, 0,57 kg

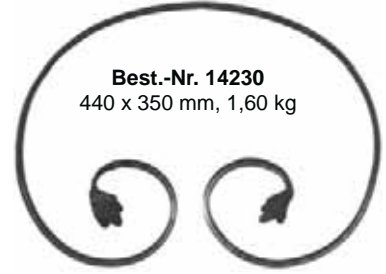

Best.-Nr. 14230  
440 x 350 mm, 1,60 kg

240 x 400 mm, 1,01 kg



Best.-Nr.  
14215



Best.-Nr.  
14216



Best.-Nr. 14208  
100 x 160 mm, 0,37 kg

**AK FER**

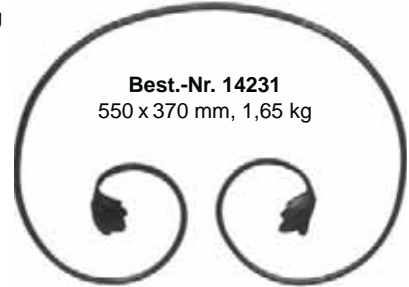

Best.-Nr. 14231  
550 x 370 mm, 1,65 kg

140 x 330 mm, 1,20 kg



Best.-Nr.  
14234



Best.-Nr.  
14235



Detail Ausschmiedung / Patte d'oie  
Forge Detail / Dettagli di fabbricazione  
Uçlar sıcak şahmerdan dövme

Best.-Nr.  
14223

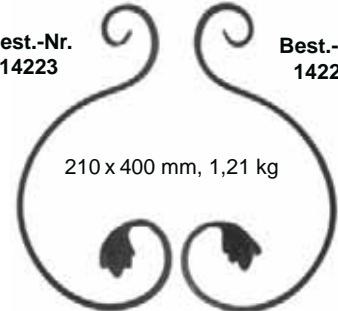

Best.-Nr.  
14224

210 x 400 mm, 1,21 kg

140 x 420 mm, 0,80 kg



Best.-Nr.  
14221



Best.-Nr.  
14222

270 x 710 mm, 2,20 kg

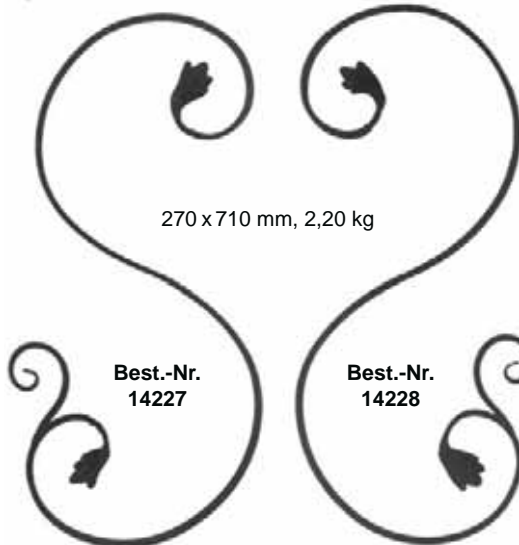

Best.-Nr.  
14227

Best.-Nr.  
14225



Best.-Nr.  
14226

280 x 500 mm, 1,14 kg

**AK FER**

**Designstäbe / Barreaux design**  
**Design bars / Barre decorative / Dizayn çubuklar**

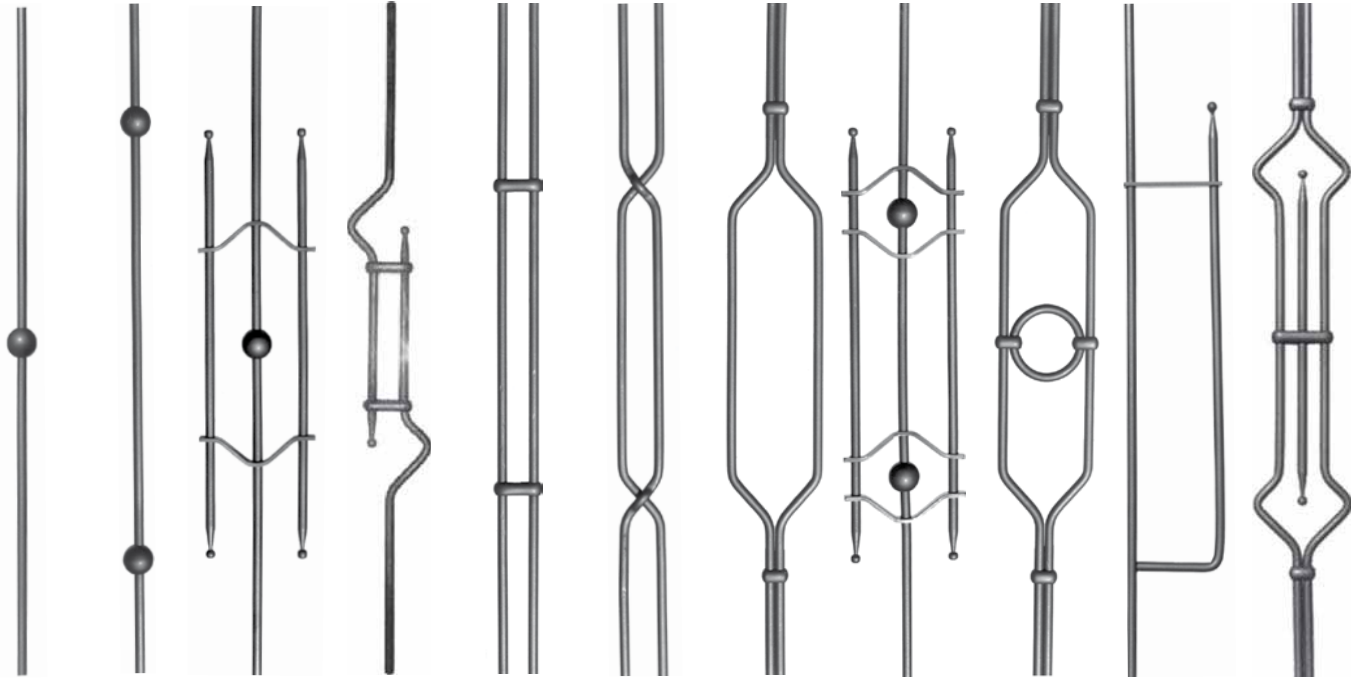

Best.-Nr.	Best.-Nr.	Best.-Nr.	Best.-Nr.	Best.-Nr.	Best.-Nr.	Best.-Nr.	Best.-Nr.	Best.-Nr.	Best.-Nr.	Best.-Nr.
<b>5500</b>	<b>5501</b>	<b>5512</b>	<b>5521</b>	<b>5502</b>	<b>5503</b>	<b>5506</b>	<b>5513</b>	<b>5507</b>	<b>5505</b>	<b>5508</b>
40 x 40 mm	40 x 600 mm	150 x 550 mm	110 x 430 mm	55 x 900 mm	60 x 900 mm	125 x 460 mm	150 x 550 mm	125 x 460 mm	120 x 600 mm	130 x 540 mm
0,91 kg	0,97kg	2,18 kg	1,40 kg	1,87 kg	1,84 kg	1,77 kg	2,45 kg	2,17 kg	1,59 kg	2,34 kg

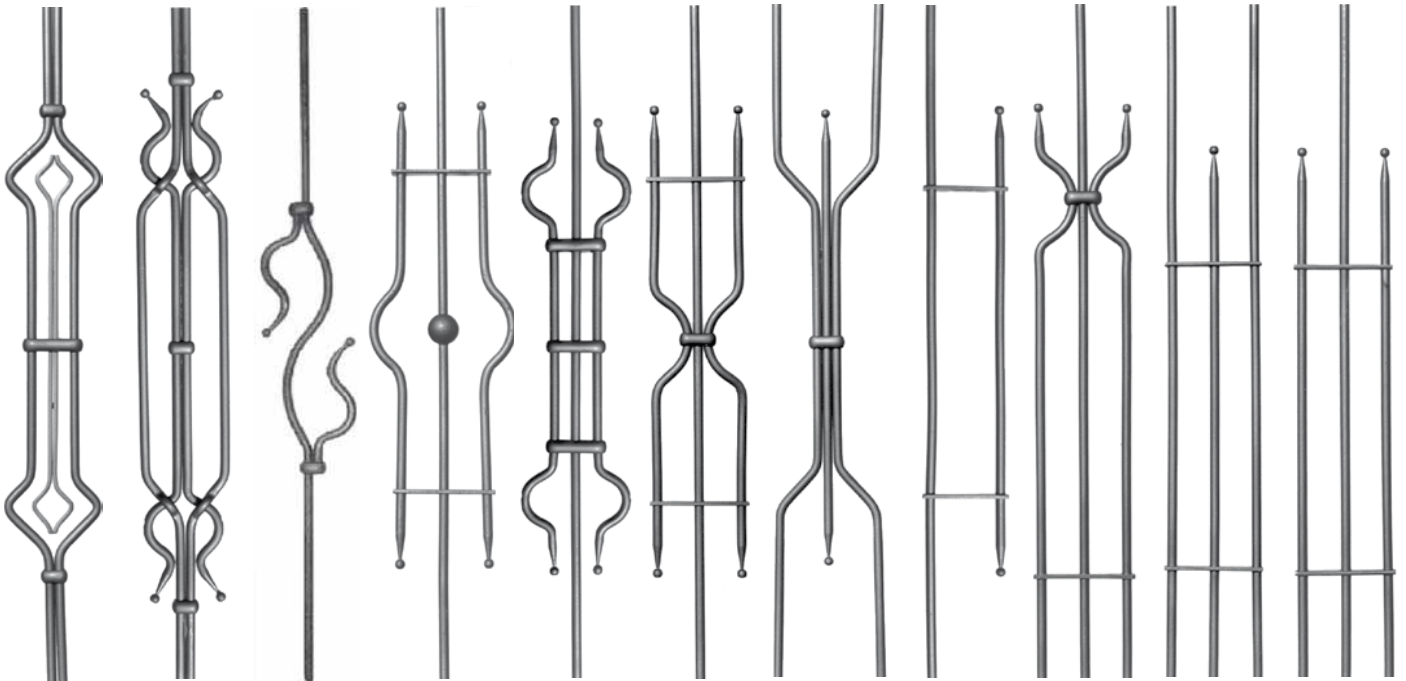

Best.-Nr.	Best.-Nr.	Best.-Nr.	Best.-Nr.	Best.-Nr.	Best.-Nr.	Best.-Nr.	Best.-Nr.	Best.-Nr.	Best.-Nr.	Best.-Nr.
<b>5509</b>	<b>5510</b>	<b>5520</b>	<b>5519</b>	<b>5516</b>	<b>5517</b>	<b>5518</b>	<b>5504</b>	<b>5511</b>	<b>5515</b>	<b>5514</b>
130 x 540 mm	125 x 660 mm	125 x 355 mm	190 x 600 mm	140 x 600 mm	125 x 600 mm	140 x 600 mm	105 x 600 mm	125 x 700 mm	125 x 700 mm	125 x 700 mm
2,50 kg	3,12 kg	1,50 kg	2,14 kg	2,18 kg	2,26kg	2,39 kg	1,53 kg	2,43 kg	2,56 kg	2,32 kg

## AK FER



Best.-Nr.  
**6512**  
144x600 mm  
1,03 kg



Best.-Nr.  
**6513**  
144x1000 mm  
1,75 kg



Best.-Nr.  
**6514**  
144x1500 mm  
2,65 kg

Best.-Nr.  
**6515**  
134x600 mm  
1,01 kg

Best.-Nr.  
**6516**  
134x1000 mm  
1,73 kg

Best.-Nr.  
**6517**  
134x1500 mm  
2,63 kg



Länge / Longueur Length / Lunghezza Uzunluk /mm	Material / Matériau Material / Materiale Malzeme	Best.-Nr.
600	Ø12	6519
1000	Ø12	6520
1500	Ø12	6521
600	12 x 12	6522
1000	12 x 12	6523
1500	12 x 12	6524

Top



Best.-Nr.  
**6501**  
155 x 90 mm  
0,38 kg



Best.-Nr.  
**6500**  
190 x 100 mm  
0,45 kg



Best.-Nr.  
**6509**  
120 x 85 mm  
0,30 kg



Best.-Nr.  
**6510**  
160 x 100 mm  
0,35 kg



Best.-Nr.  
**6511**  
220 x 105 mm  
0,38 kg



Best.-Nr.  
**6502**  
165x60 mm  
0,15 kg



Best.-Nr.  
**6505**  
120 x 110 mm  
0,23 kg



Best.-Nr.  
**6504**  
130 x 100 mm  
0,22 kg



Best.-Nr.  
**6507**  
180 x 115 mm  
0,35 kg



Best.-Nr.  
**6508**  
155 x 100 mm  
0,32 kg



Best.-Nr.  
**6506**  
115x120 mm  
0,24 kg



Best.-Nr.  
**6503**  
215x90 mm  
0,29 kg

## AK FER

### U- Bunde / Colliers en U / U-Collars / Collari a U / U-Bilezikler

#### Material 12 x 3 mm

Für / for / pour mm	Best.-Nr.
12 x 12	6021
18 x 12	6022
24 x 12	6023



#### U-Bund überlappend / Colliers en U à rabattre U-Collar overlapped / Collari a U ribattuti U-Bilezik binmeli Material 14 x 4 mm

Für / for / pour mm	Best.-Nr.
12 x 12	6080
18 x 12	6081
24 x 12	6082

#### Material 16 x 3 mm

Für / for / pour mm	Best.-Nr.
12 x 12	6026
18 x 12	6027
24 x 12	6028
36 x 12	6029
16 x 16	6096
24 x 16	6097
32 x 16	6098

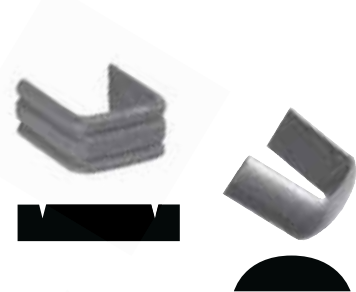

#### Material 16 x 5 mm, für/for/pour ● 12 mm

Für / for / pour mm	Best.-Nr.
12 x 12	6090
18 x 12	6091
24 x 12	6092
36 x 12	6093
48 x 12	6094
60 x 12	6095

#### Material 12 x 3 mm, für/for/pour ● 12 mm

Für / for / pour mm	Best.-Nr.
24 x 12	6083
36 x 12	6084



## AK FER

Achtung: Angabe der „Für Abmessung“  
bezieht sich auf das zu bindende Material!



**AK FER**

**Zierstäbe, glatt / Balustres, lisses / Ornamental balusters, plain edges**  
**Balaustre decorative, semplici / Motifli çubuklar-düz**

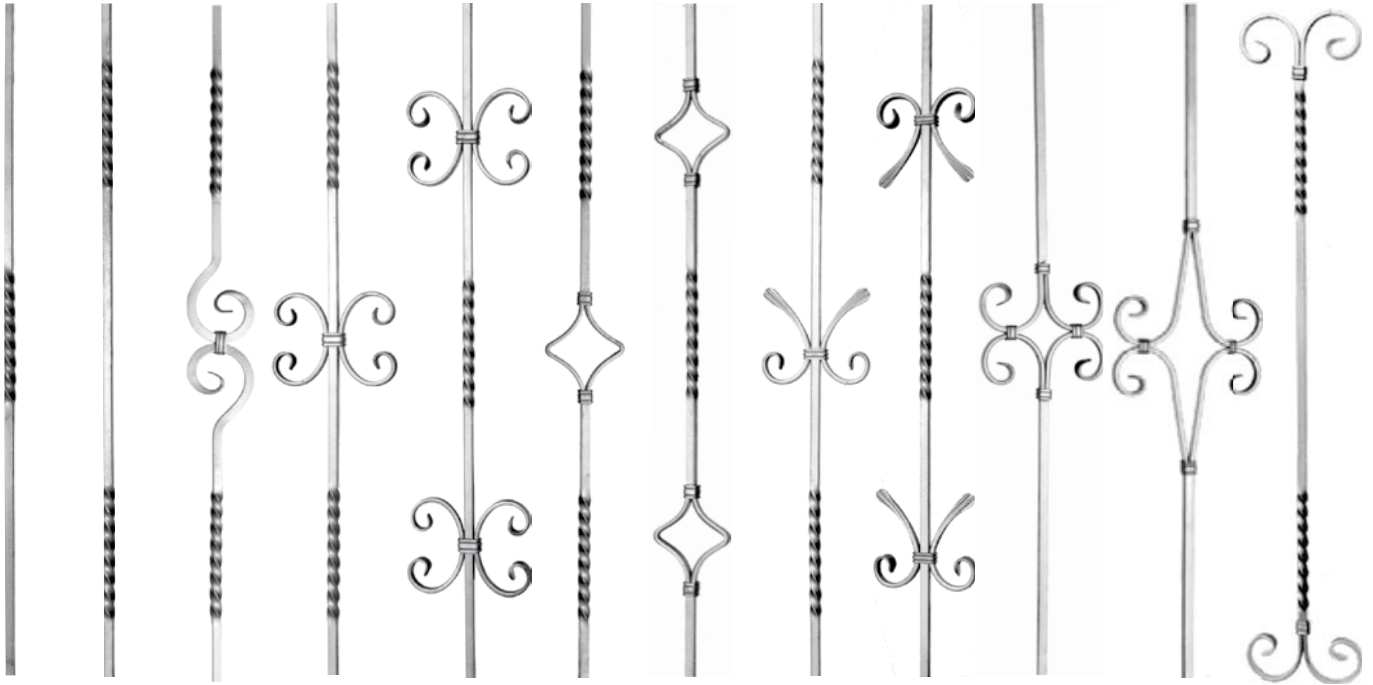

Best.-Nr. <b>5001</b> 15 x 160 mm 1,00 kg	Best.-Nr. <b>5002</b> 15 x 700 mm 0,99 kg	Best.-Nr. <b>5008</b> 80 x 200 mm 1,30 kg	Best.-Nr. <b>5014</b> 150 x 120 mm 1,36 kg	Best.-Nr. <b>5015</b> 150 x 640 mm 1,67 kg	Best.-Nr. <b>5009</b> 100 x 120 mm 1,06 kg	Best.-Nr. <b>5010</b> 100 x 640 mm 1,16 kg	Best.-Nr. <b>5037</b> 130 x 120 mm 1,24 kg	Best.-Nr. <b>5038</b> 130 x 640 mm 1,52 kg	Best.-Nr. <b>5011</b> 150 x 160 mm 1,31 kg	Best.-Nr. <b>5013</b> 190 x 320 mm 1,34 kg	Best.-Nr. <b>5006</b> 160 x 900 mm 1,33 kg
--	--	--	---	---	---	---	---	---	---	---	---

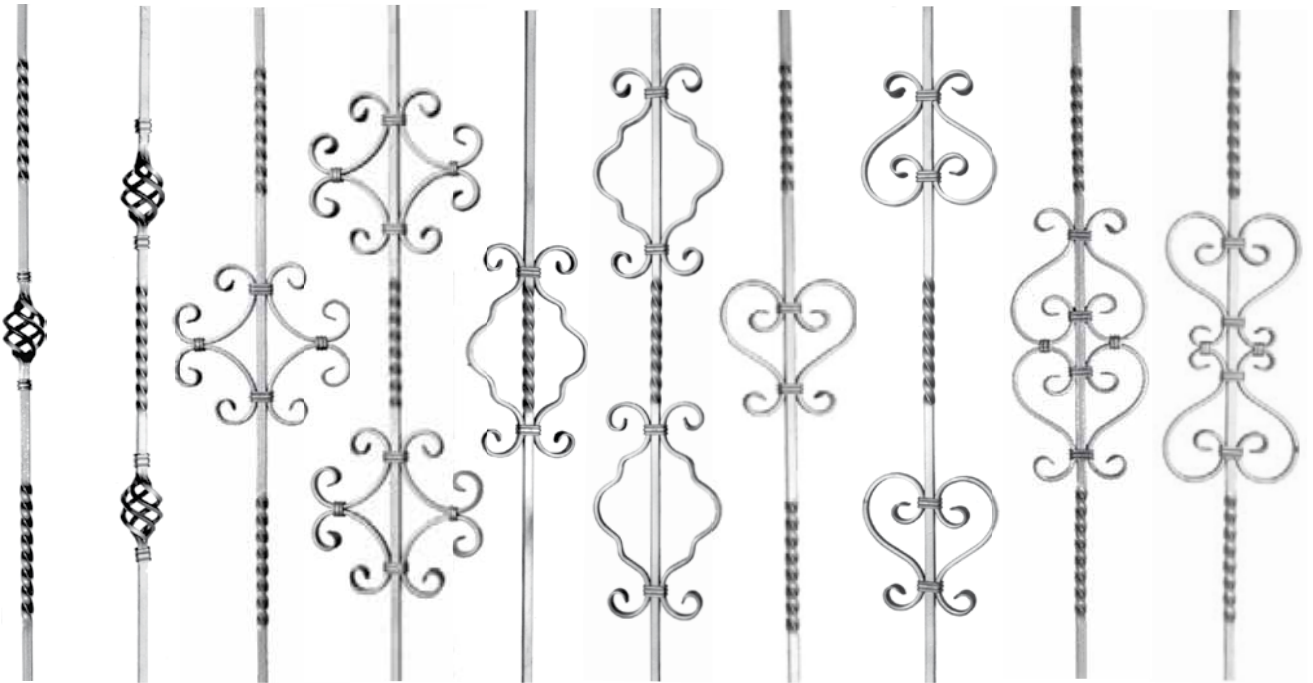

Best.-Nr. <b>5007</b> 60 x 80 mm 1,06 kg	Best.-Nr. <b>5046</b> 60 x 540 mm 1,13 kg	Best.-Nr. <b>5018</b> 220 x 210 mm 1,69 kg	Best.-Nr. <b>5019</b> 220x640 mm 2,45 kg	Best.-Nr. <b>5040</b> 160 x 270 mm 1,59 kg	Best.-Nr. <b>5041</b> 160 x 700 mm 2,17 kg	Best.-Nr. <b>5031</b> 170 x 170 mm 1,53 kg	Best.-Nr. <b>5030</b> 170 x 640 mm 1,98 kg	Best.-Nr. <b>5026</b> 170 x 340 mm 2,00 kg	Best.-Nr. <b>5027</b> 170 x 340 mm 2,00 kg
---	--	---	---	---	---	---	---	---	---

**AK FER**

**Zierstäbe, glatt / Balustres, lisses / Ornamental balusters, plain edges**  
**Balaustre decorative, semplici / Motifli çubuklar-düz**

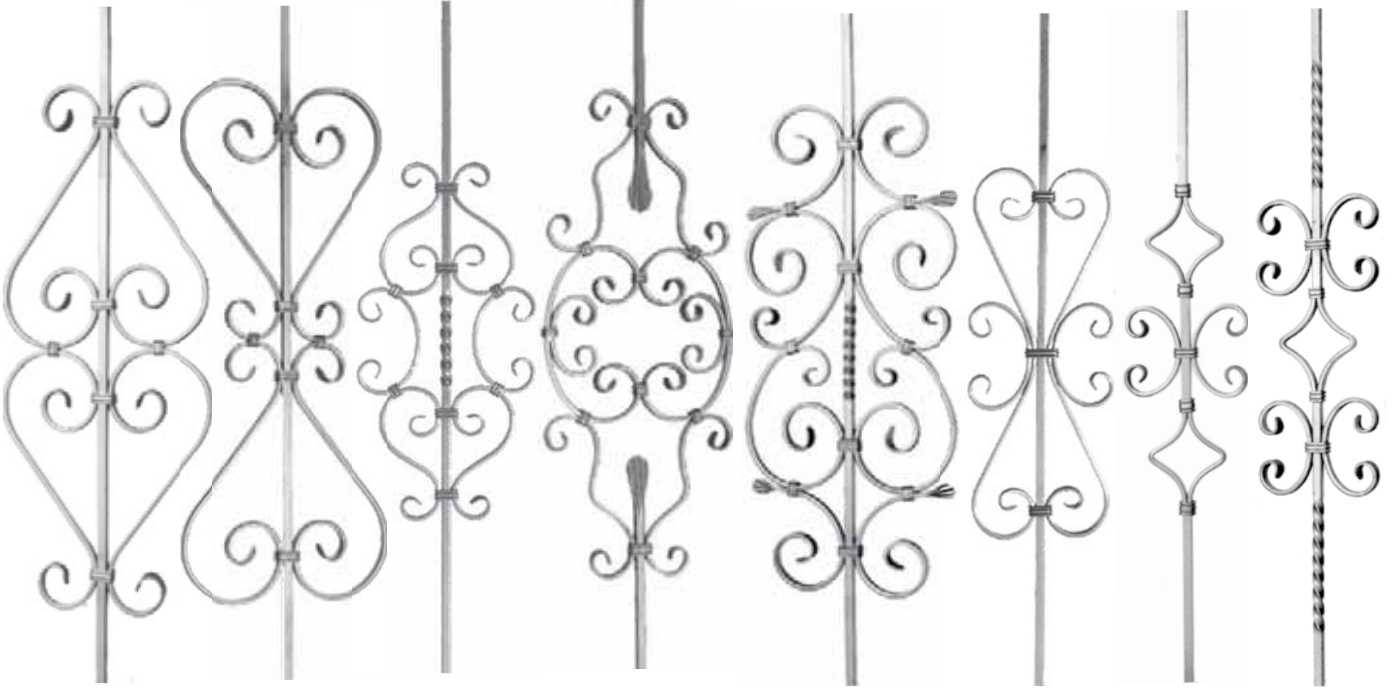

Best.-Nr.  
**5028**  
270 x 660 mm  
2,75 kg

Best.-Nr.  
**5029**  
270 x 660 mm  
2,75 kg

Best.-Nr.  
**5045**  
230 x 460 mm  
2,49 kg

Best.-Nr.  
**5022**  
250 x 620 mm  
2,64 kg

Best.-Nr.  
**5047**  
280 x 620 mm  
3,42 kg

Best.-Nr.  
**5050**  
185 x 475 mm  
2,32 kg

Best.-Nr.  
**5043**  
150 x 375 mm  
1,53 kg

Best.-Nr.  
**5044**  
150 x 375 mm  
1,77 kg

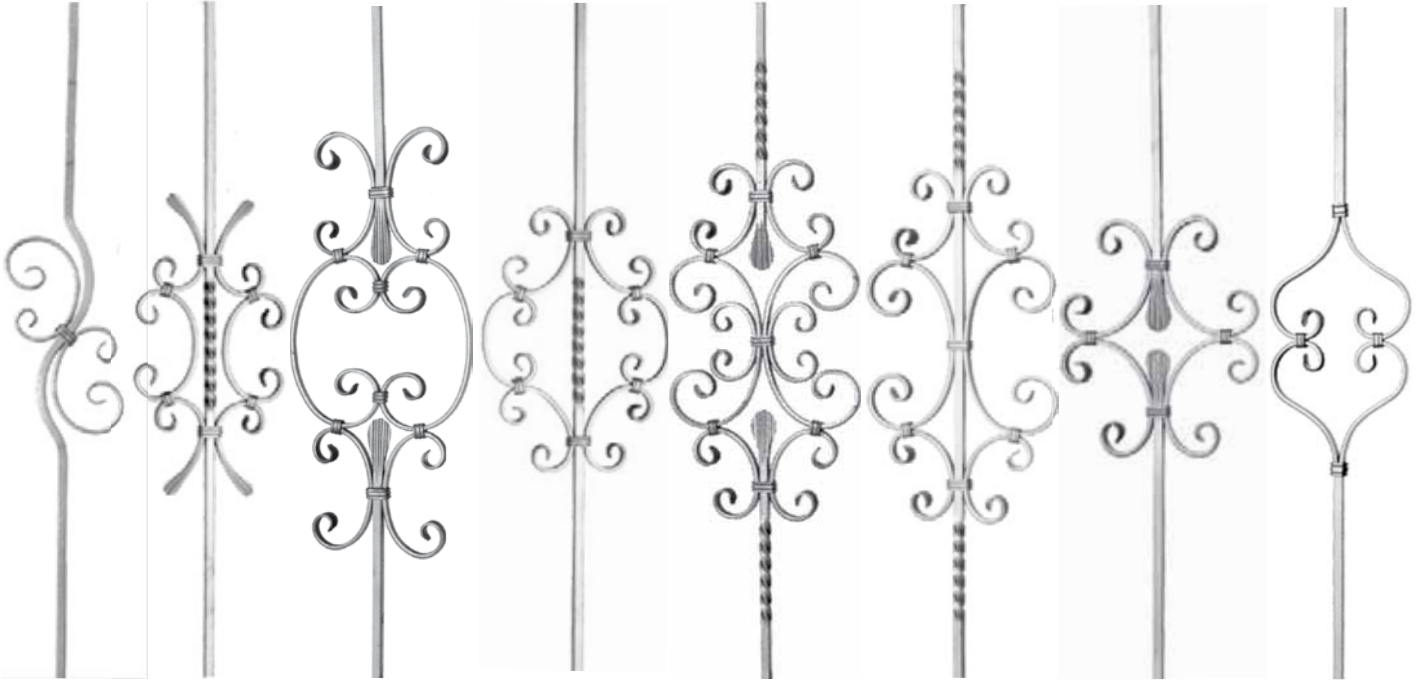

Best.-Nr.  
**5051**  
150 x 250 mm  
1,47 kg

Best.-Nr.  
**5039**  
185 x 360 mm  
1,97 kg

Best.-Nr.  
**5023**  
250 x 540 mm  
2,32 kg

Best.-Nr.  
**5017**  
250 x 340 mm  
2,10 kg

Best.-Nr.  
**5021**  
250 x 450 mm  
2,57 kg

Best.-Nr.  
**5016**  
250 x 450 mm  
2,41 kg

Best.-Nr.  
**5024**  
250 x 300 mm  
1,90 kg

Best.-Nr.  
**5012**  
180 x 320 mm  
1,33 kg

## Zierstäbe, kantengehämmt / Balustres, Martelé

### Ornamental balusters, Hammered edges / Balaustre, Bordi martellati / Köşe dövme motifli çubuklar

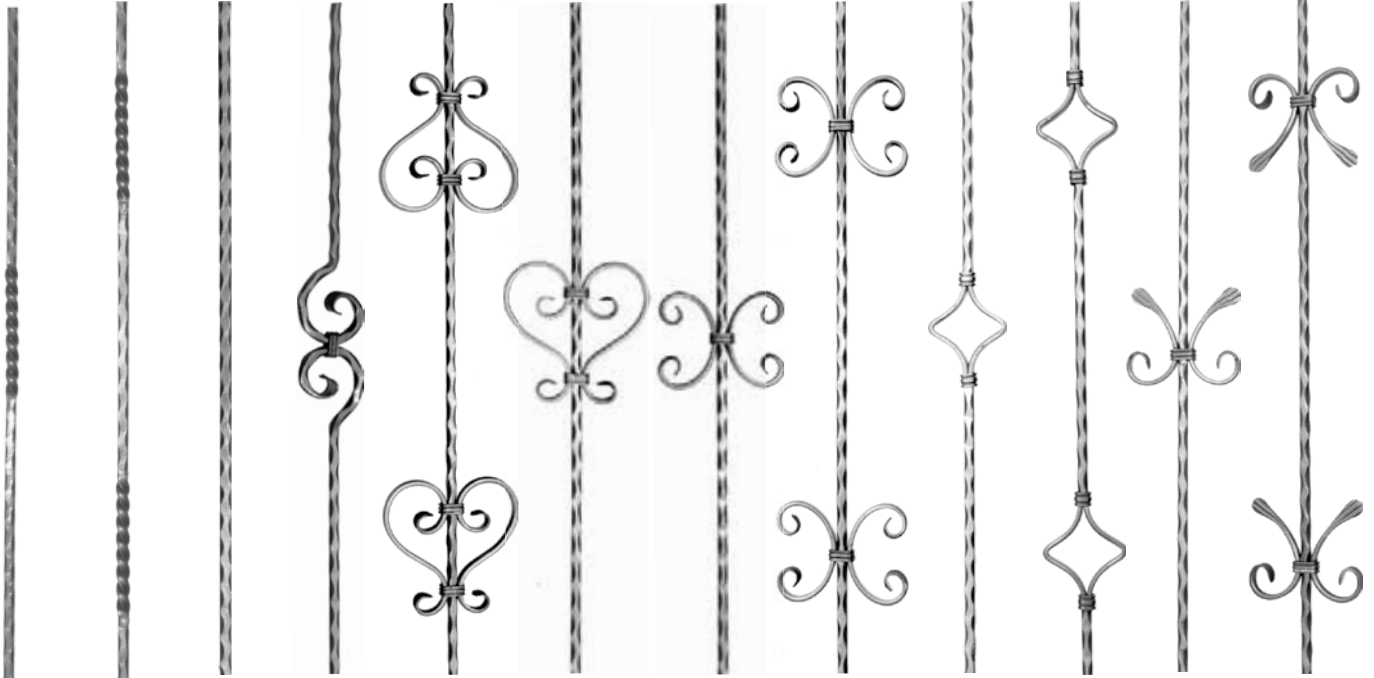

Best.-Nr.	Best.-Nr.	Best.-Nr.	Best.-Nr.	Best.-Nr.	Best.-Nr.	Best.-Nr.	Best.-Nr.	Best.-Nr.	Best.-Nr.	Best.-Nr.	Best.-Nr.
5101	5102	5100	5108	5130	5131	5114	5115	5109	5110	5137	5138
15 x 160 mm	15 x 700 mm	12 x 900 mm	80 x 200 mm	170 x 640 mm	170 x 170 mm	150 x 120 mm	150 x 640 mm	100 x 120 mm	100 x 640 mm	130 x 120 mm	130 x 640 mm
0,98 kg	0,98 kg	0,92 kg	1,14 kg	1,84 kg	1,34 kg	1,24 kg	1,61 kg	1,00 kg	1,06 kg	1,07 kg	1,34 kg

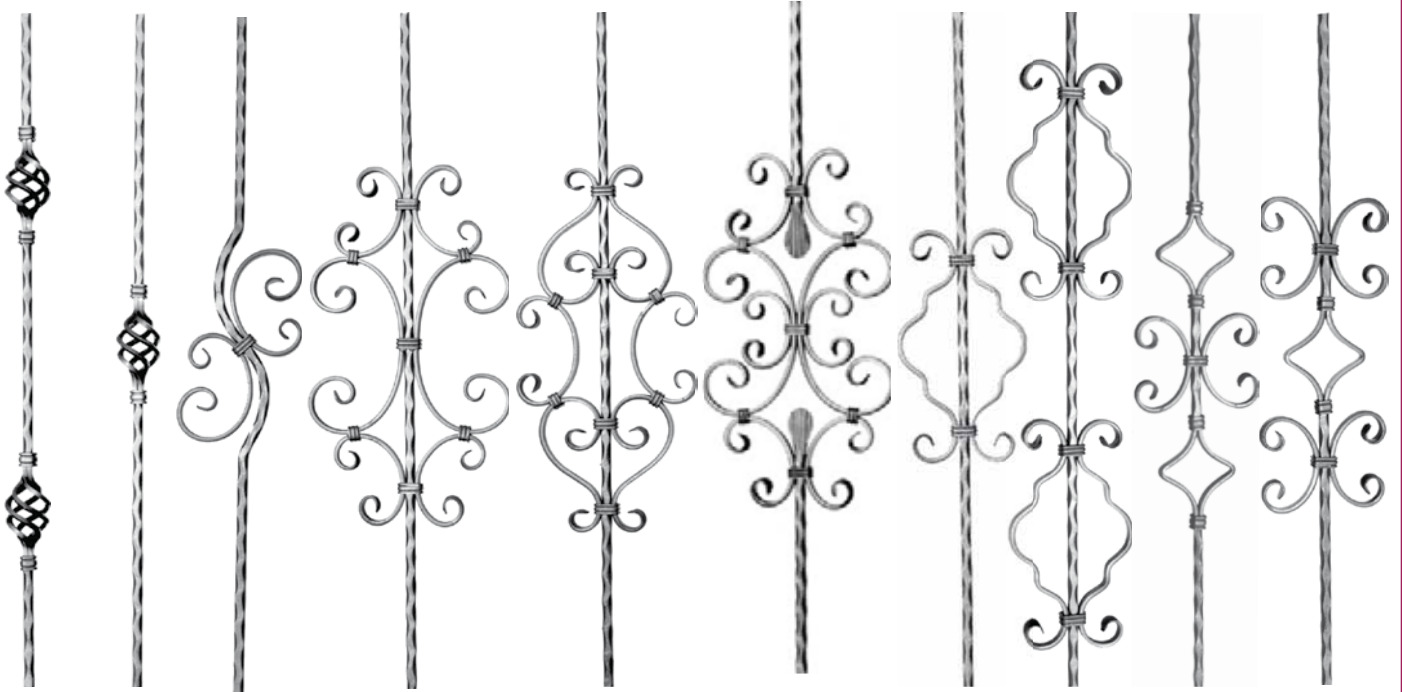

Best.-Nr.	Best.-Nr.	Best.-Nr.	Best.-Nr.	Best.-Nr.	Best.-Nr.	Best.-Nr.	Best.-Nr.	Best.-Nr.	Best.-Nr.
5146	5107	5151	5116	5145	5121	5140	5141	5143	5144
60 x 540 mm	60 x 80 mm	150 x 250 mm	250 x 450 mm	230 x 460 mm	250 x 450 mm	160 x 270 mm	160 x 700 mm	150 x 375 mm	150 x 375 mm
1,08 kg	0,96 kg	1,45 kg	2,34 kg	2,31 kg	2,47 kg	1,40 kg	1,96 kg	1,40 kg	1,69 kg



## Zierstäbe, kantengehämert / Balustres, Martelé

### Ornamental balusters, Hammered edges / Balaustre, Bordi martellati / Köşe dövme motifli çubuklar

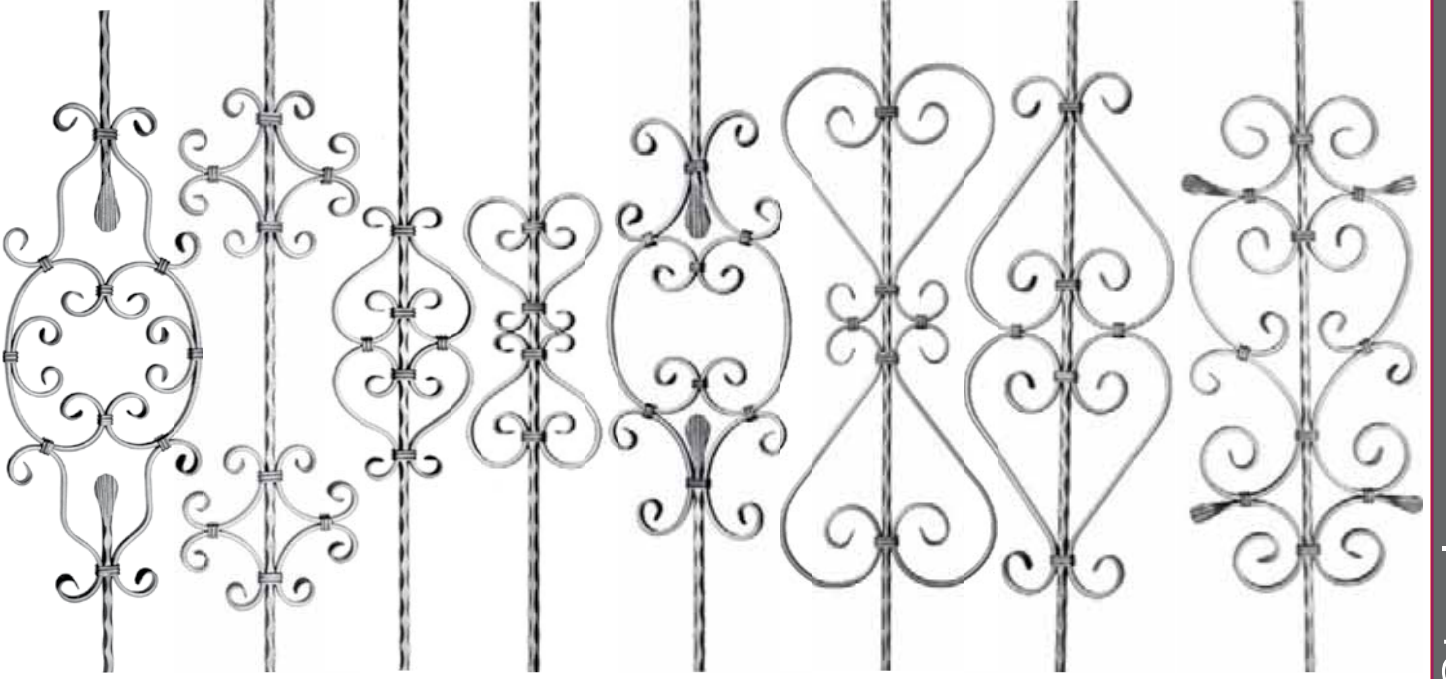

Best.-Nr.

**5122**

250 x 620 mm  
2,61 kg

Best.-Nr.

**5119**

220 x 640 mm  
2,33 kg

Best.-Nr.

**5126**

170 x 340 mm  
1,85 kg

Best.-Nr.

**5127**

170 x 340 mm  
1,85 kg

Best.-Nr.

**5123**

250 x 540 mm  
2,39 kg

Best.-Nr.

**5129**

270 x 660 mm  
2,65 kg

Best.-Nr.

**5128**

270 x 660 mm  
2,65 kg

Best.-Nr.

**5147**

280 x 620 mm  
3,37 kg

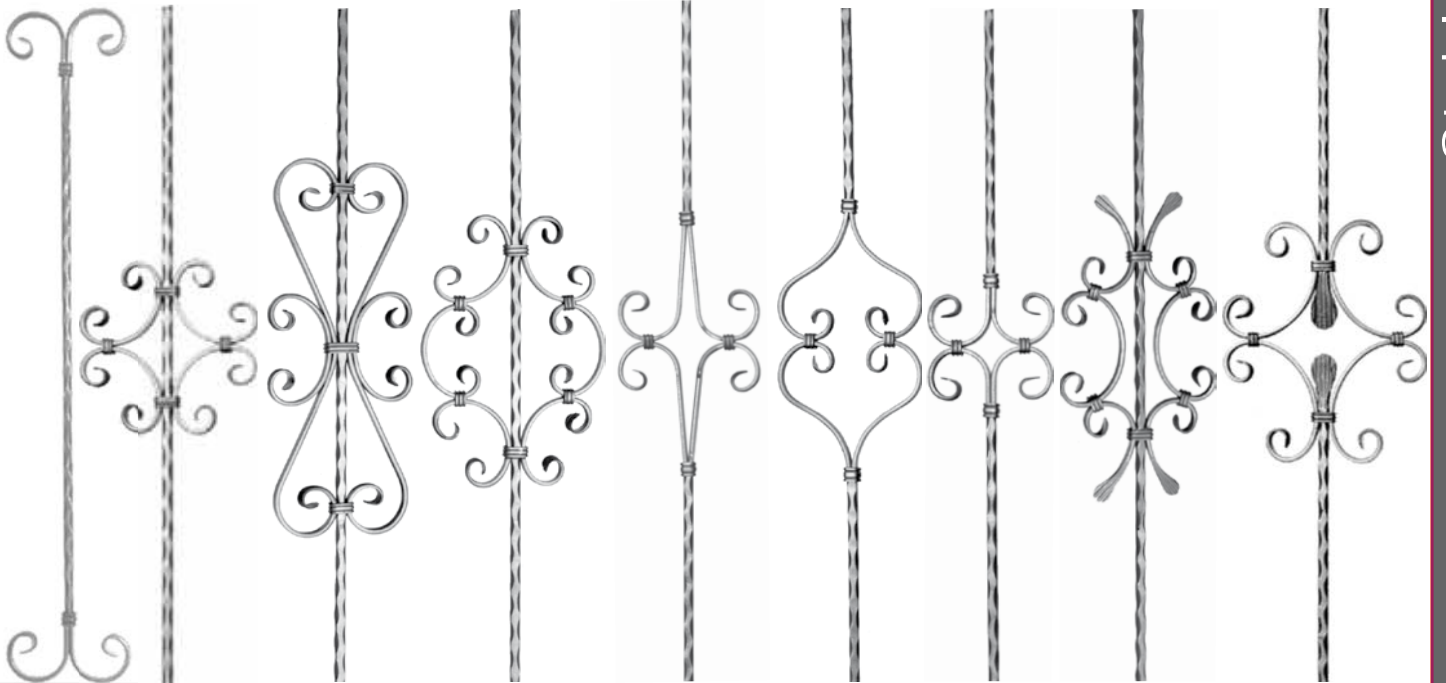

Best.-Nr.

**5106**

160 x 900 mm  
1,25 kg

Best.-Nr.

**5118**

220 x 210 mm  
1,59 kg

Best.-Nr.

**5150**

185 x 475 mm  
2,27 kg

Best.-Nr.

**5117**

250 x 340 mm  
2,00 kg

Best.-Nr.

**5113**

190 x 320 mm  
1,35 kg

Best.-Nr.

**5112**

180 x 320 mm  
1,26 kg

Best.-Nr.

**5111**

150 x 160 mm  
1,27 kg

Best.-Nr.

**5139**

185 x 360 mm  
1,77 kg

Best.-Nr.

**5124**

250 x 300 mm  
1,81 kg



**AK FER**

**Leichtbarock- Zierstäbe, glatt / Balustres lisses baroque léger**  
**Light Baroque balusters, plain edges / Barra semplice a motivo barocco**  
**Hafif Barok motifli çubuklar, düz**



Best.-Nr.  
**5206**  
180 x 340 mm  
1,41 kg

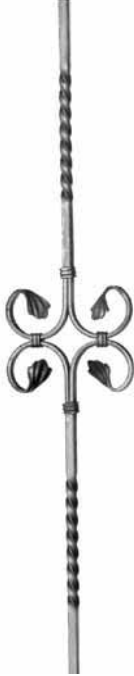

Best.-Nr.  
**5207**  
170 x 180 mm  
1,34 kg



Best.-Nr.  
**5205**  
195 x 320 mm  
1,38 kg



Best.-Nr.  
**5203**  
170 x 120 mm  
1,39 kg



Best.-Nr.  
**5204**  
170 x 640 mm  
1,82 kg



Best.-Nr.  
**5225**  
260 x 290 mm  
1,92 kg



Best.-Nr.  
**5210**  
170 x 410 mm  
1,54 kg



Best.-Nr.  
**5211**  
170 x 375 mm  
1,88 kg



Best.-Nr.  
**5224**  
170 x 900 mm  
1,35 kg



Best.-Nr.  
**5219**  
260 x 450 mm  
2,59 kg



Best.-Nr.  
**5218**  
250 x 530 mm  
2,44 kg

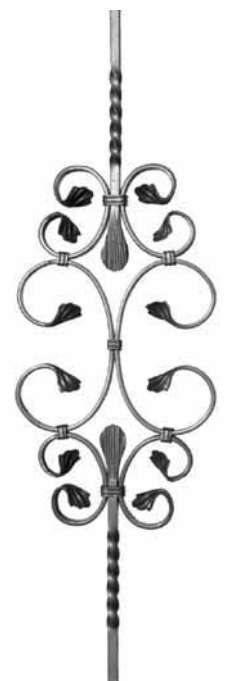

Best.-Nr.  
**5220**  
240 x 450 mm  
2,31 kg

**AK FER**

**Leichtbarock-Zierstäbe, glatt / Balustres lisses baroque léger**  
**Light Baroque balusters, plain edges / Barra semplice a motivo barocco**  
**Hafif Barok motifli çubuklar, düz**

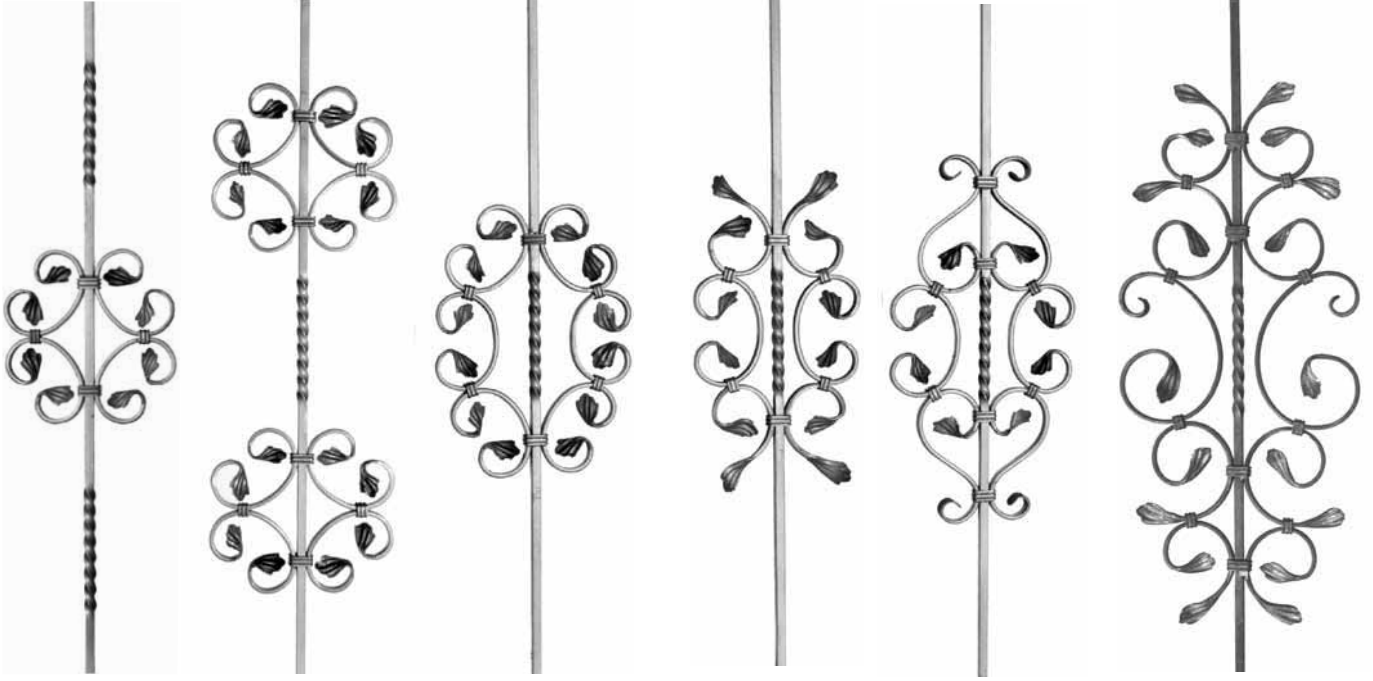

Best.-Nr.  
**5208**  
220 x 220 mm  
1,84 kg

Best.-Nr.  
**5209**  
220 x 640 mm  
2,60 kg

Best.-Nr.  
**5214**  
250 x 340 mm  
2,24 kg

Best.-Nr.  
**5212**  
210 x 460 mm  
2,11 kg

Best.-Nr.  
**5213**  
240 x 460 mm  
2,46 kg

Best.-Nr.  
**5201**  
280 x 620 mm  
3,33 kg

**AK FER**



Best.-Nr.  
**5223**  
300 x 620 mm  
3,23 kg

Best.-Nr.  
**5221**  
290 x 660 mm  
2,70 kg

Best.-Nr.  
**5222**  
290 x 660 mm  
2,70 kg

Best.-Nr.  
**5217**  
170 x 340 mm  
1,95 kg

Best.-Nr.  
**5216**  
170 x 340 mm  
1,95 kg

**AK FER**

**Leichtbarock- Zierstäbe, kantengehäm. / Balustres baroque léger, martelées**  
**Light Baroque balusters, hammered / Balaustre decorative, bordi martellati**  
**Hafif Barok motifli çubuklar, köşe dövme**

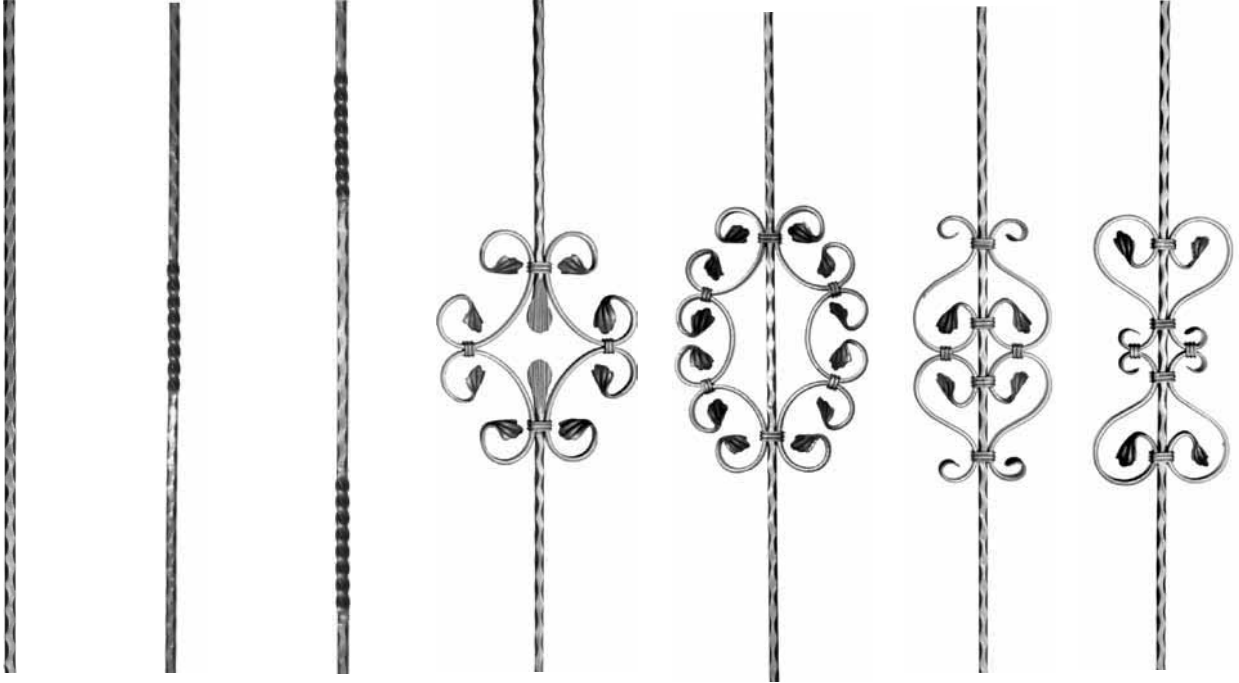

Best.-Nr.  
**5100**  
12 x 900 mm  
0,92 kg

Best.-Nr.  
**5101**  
15 x 160 mm  
0,98 kg

Best.-Nr.  
**5102**  
15 x 700 mm  
0,98 kg

Best.-Nr.  
**5325**  
260 x 290 mm  
1,84 kg

Best.-Nr.  
**5314**  
250 x 340 mm  
2,20 kg

Best.-Nr.  
**5316**  
170 x 340 mm  
1,85 kg

Best.-Nr.  
**5317**  
170 x 340 mm  
1,79 kg



Best.-Nr.  
**5313**  
240 x 460 mm  
2,32 kg

Best.-Nr.  
**5320**  
240 x 450 mm  
2,28 kg

Best.-Nr.  
**5321**  
290 x 660 mm  
2,70 kg

Best.-Nr.  
**5322**  
290 x 660 mm  
2,70 kg

Best.-Nr.  
**5323**  
300 x 620 mm  
3,28 kg

Best.-Nr.  
**5301**  
280 x 620 mm  
3,27 kg



**AK FER**

**Leichtbarock- Zierstäbe, kantengehäm. / Balustres baroque léger, martelées**  
**Light Baroque balusters, hammered / Balaustre decorative, bordi martellati**  
**Hafif Barok motifli çubuklar, köşe dövme**

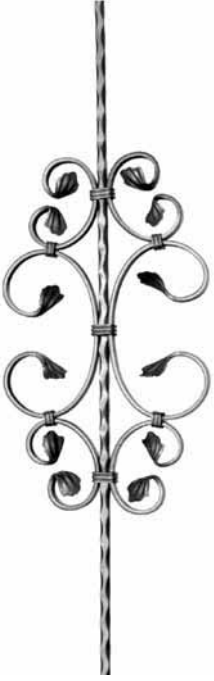

Best.-Nr.  
**5319**  
260 x 450 mm  
2,47 kg



Best.-Nr.  
**5305**  
195 x 320 mm  
1,35 kg



Best.-Nr.  
**5306**  
180 x 340 mm  
1,29 kg

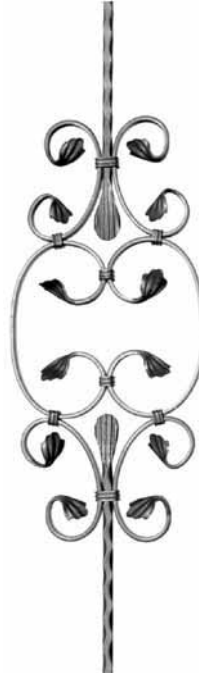

Best.-Nr.  
**5318**  
250 x 340 mm  
2,45 kg



Best.-Nr.  
**5303**  
170 x 120 mm  
1,27 kg



Best.-Nr.  
**5304**  
170 x 640 mm  
1,66 kg



Best.-Nr.  
**5310**  
170 x 375 mm  
1,47 kg



Best.-Nr.  
**5311**  
170 x 375 mm  
1,83 kg



Best.-Nr.  
**5308**  
220 x 220 mm  
1,70 kg

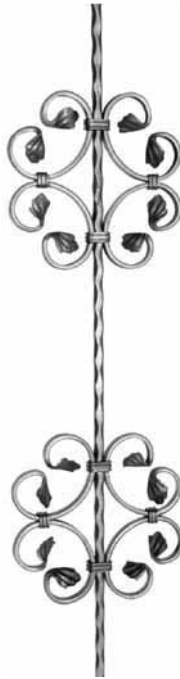

Best.-Nr.  
**5309**  
220 x 640 mm  
2,68 kg



Best.-Nr.  
**5312**  
210 x 400 mm  
2,05 kg



Best.-Nr.  
**5307**  
170 x 180 mm  
1,29 kg



Best.-Nr.  
**5324**  
170 x 900 mm  
1,25 kg



**AK FER**

**Schmiedestäbe / Balustres forgées**  
**Forged balusters / Barre per balaustre, forgiate / Dövme çubuklar**

**Länge / Longueur / Length / Lunghezza / Uzunluk: 1000 mm**



Best.-Nr. <b>5442</b> 12x12 mm 1,10kg	Best.-Nr. <b>5401</b> 12x12 mm 1,50kg	Best.-Nr. <b>5406</b> 12x12 mm 1,80 kg	Best.-Nr. <b>5410</b> 12x12 mm 1,55 kg	Best.-Nr. <b>5411</b> 12x12 mm 1,95 kg	Best.-Nr. <b>5434</b> ø 12 mm 1,06 kg	Best.-Nr. <b>5435</b> ø 12 mm 1,10 kg	Best.-Nr. <b>5417</b> ø 14 mm 1,25 kg	Best.-Nr. <b>5418</b> ø 14 mm 1,30 kg	Best.-Nr. <b>5415</b> ø 14 mm 1,20 kg	Best.-Nr. <b>5414</b> ø 14 mm 1,20 kg	Best.-Nr. <b>5412</b> 12x12 mm 1,10 kg	Best.-Nr. <b>5413</b> 12x12 mm 1,10 kg
--	--	---	---	---	--	--	--	--	--	--	---	---

**Länge / Longueur / Length / Lunghezza / Uzunluk: 1000 mm**

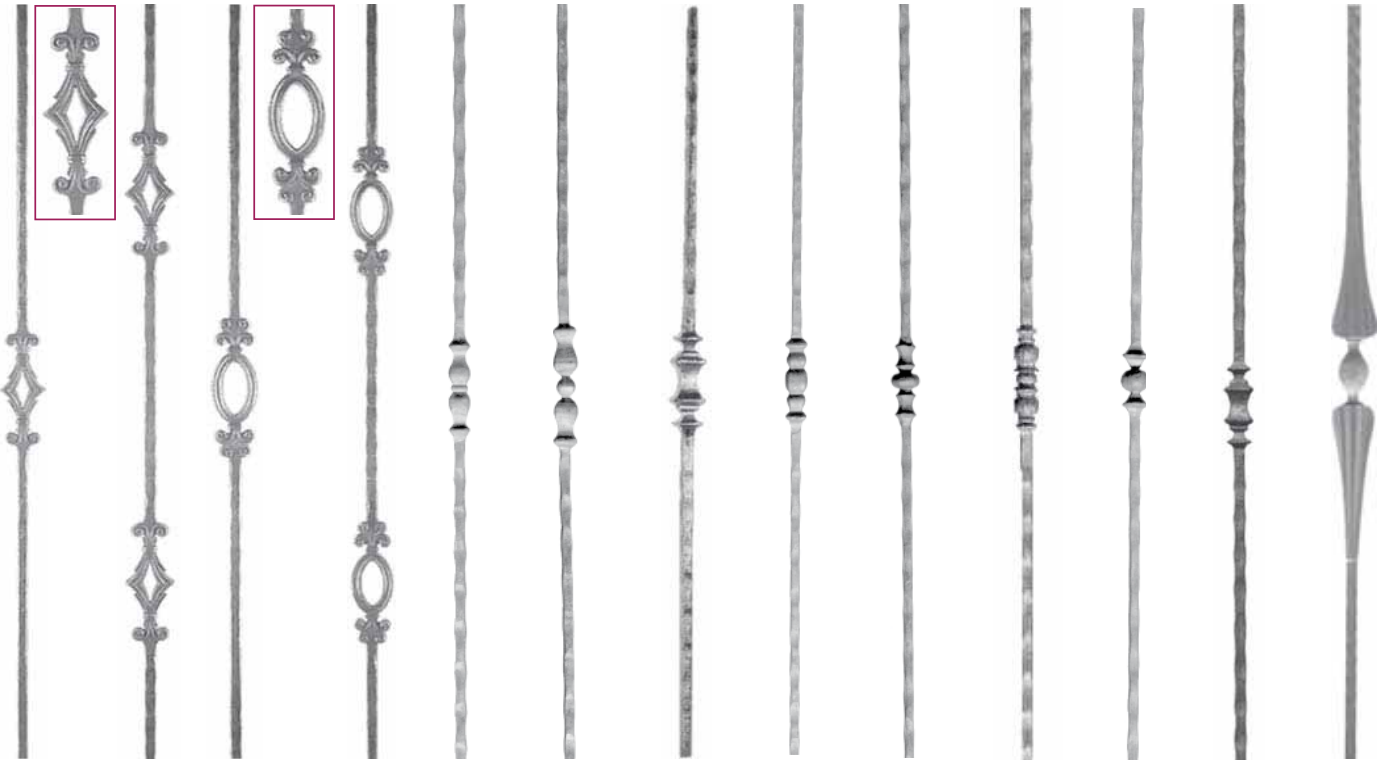

Best.-Nr. <b>5421</b> 14 x14 mm 1,65 kg	Best.-Nr. <b>5425</b> 14x14 mm 1,80 kg	Best.-Nr. <b>5422</b> 14x14 mm 1,65 kg	Best.-Nr. <b>5428</b> 14x14 mm 1,80 kg	Best.-Nr. <b>5400</b> 12x12 mm 1,30 kg	Best.-Nr. <b>5402</b> 12x12 mm 1,65 kg	Best.-Nr. <b>5436</b> 14x14 mm 2,11 kg	Best.-Nr. <b>5407</b> 12x12 mm 1,65 kg	Best.-Nr. <b>5404</b> 12x12 mm 1,55 kg	Best.-Nr. <b>5408</b> 12x12 mm 1,70 kg	Best.-Nr. <b>5409</b> 13 x13 mm 1,24 kg	Best.-Nr. <b>5405</b> 12x12 mm 1,65 kg	Best.-Nr. <b>5416</b> 14x14 mm 1,50 kg
--	---	---	---	---	---	---	---	---	---	--	---	---

Stahl St. 37 / Steel

**AK FER**

**Schmiedestäbe / Balustres forgées**  
**Forged balusters / Barre per balaustre, forgiate / Dövme çubuklar**

**Länge / Longueur / Length / Lunghezza / Uzunluk: 1000 mm**

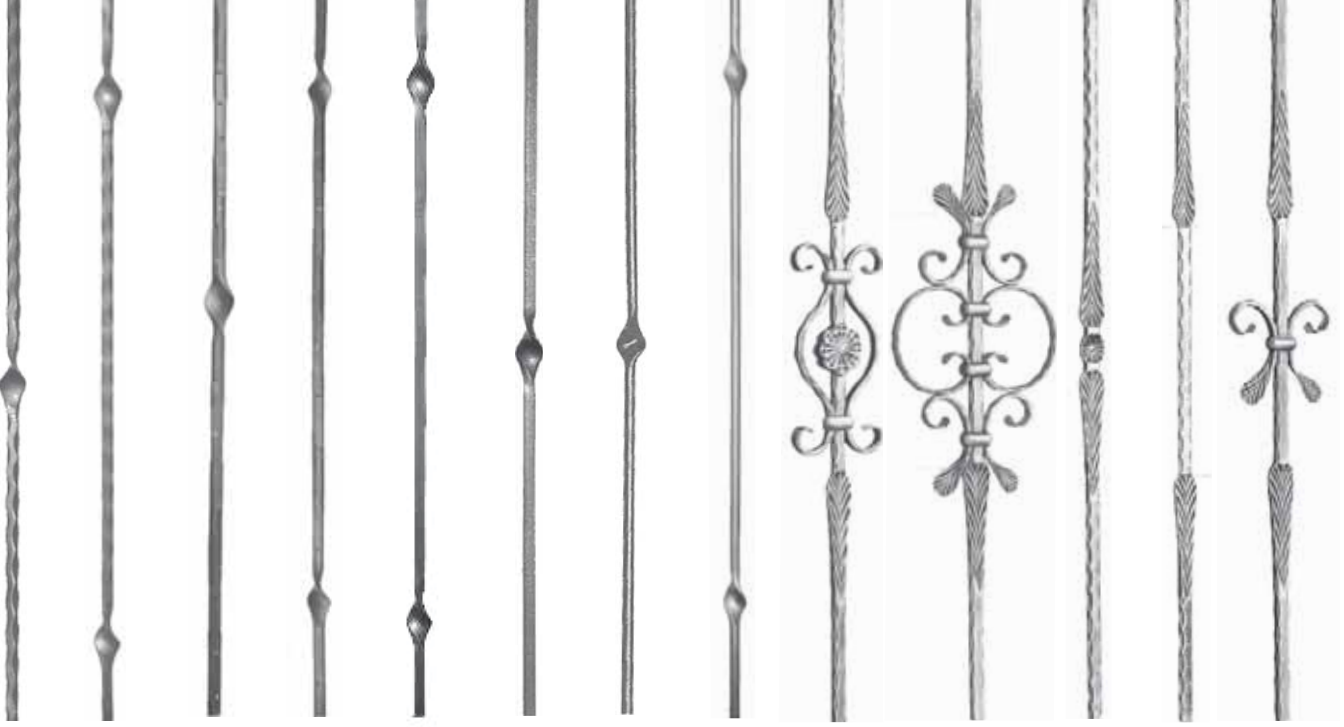

Best.-Nr. <b>5430</b> 12x12 mm kantengeh. 1,00 kg	Best.-Nr. <b>5431</b> 12x12 mm kantengeh. 1,00 kg	Best.-Nr. <b>5440</b> ø 14 mm gehämmert 1,08 kg	Best.-Nr. <b>5441</b> ø 14 mm gehämmert 1,08 kg	Best.-Nr. <b>5423</b> 12x12 mm 1,00 kg	Best.-Nr. <b>5424</b> 12x12 mm 1,00 kg	Best.-Nr. <b>5426</b> ø 12 mm 0,80 kg	Best.-Nr. <b>5427</b> ø 12 mm 0,80 kg	Best.-Nr. <b>5438</b> 12x12 mm 1,75 kg	Best.-Nr. <b>5439</b> 12x12 mm 2,01 kg	Best.-Nr. <b>5419</b> 12x12 mm kantengeh. 0,98 kg	Best.-Nr. <b>5420</b> 12x12 mm kantengeh. 1,00 kg	Best.-Nr. <b>5437</b> 12x12 mm kantengeh. 1,27 kg
---	---	---	---	---	---	--	--	---	---	---	---	---

**Länge / Longueur / Length / Lunghezza / Uzunluk: 1000 mm**



Best.-Nr. <b>5480</b> 13 x 13 mm 1,57kg	Best.-Nr. <b>5481</b> ø 14 mm 1,57 kg	Best.-Nr. <b>5482</b> ø 12 mm 1,06 kg	Best.-Nr. <b>5483</b> ø 12 mm 1,22 kg	Best.-Nr. <b>5484</b> ø 12 mm 1,02 kg	Best.-Nr. <b>5485</b> ø 12 mm 1,14 kg	Best.-Nr. <b>5486</b> ø 12 mm 1,18 kg	Best.-Nr. <b>5487</b> 12x12 mm 1,13 kg	Best.-Nr. <b>5488</b> 12x12 mm 1,13 kg	Best.-Nr. <b>5489</b> ø 12 mm 1,14 kg	Best.-Nr. <b>5490</b> ø 12 mm 1,28 kg
--	--	--	--	--	--	--	---	---	--	--



# Akbas

Konkuk & Metal Ürünleri



Bauschlosserei Höcst GmbH & Co. KG, D - 35510 Butzbach



Schlosserei Marco Müller, D - 64753 Brombachtal



Schlosserei Marco Müller, D - 64753 Brombachtal

Stahl St. 37 / Steel



Schlosserei Rupert GraBer, D - 84184 Tiefenbach





Stahl St. 37 / Steel



Schlosserei Marco Müller, D - 64753 Brombachtal



Schlosserei Marco Müller, D - 64753 Brombachtal



Länge / Longueur / Length / Lunghezza / Uzunluk: 1200 mm



Best.-Nr. **8001**  
20 x 20 mm  
3,79 kg



Best.-Nr. **8006**  
20 x 20 mm  
4,07 kg



Best.-Nr. **8003**  
20 x 20 mm  
kantengehämmert  
3,67 kg



Best.-Nr. **8008**  
20 x 20 mm  
4,12 kg



Best.-Nr. **8009**  
20 x 20 mm  
kantengehämmert  
3,79 kg



Best.-Nr. **8014**  
25 x 25 mm  
4,90 kg



Best.-Nr. **8017**  
25x25 mm  
kantengehämmert  
5,90 kg



Best.-Nr. **8015**  
25 x 25 mm  
7,30 kg



Best.-Nr. **8019**  
25 x 25 mm  
5,90 kg



Best.-Nr. **8016**  
25 x 25 mm  
6,70 kg



Best.-Nr. **8020**  
ø 25 mm  
4,60 kg



Best.-Nr. **8018**  
25 x 25 mm  
5,85 kg



Best.-Nr. **8021**  
25 x 25 mm  
4,70 kg



Best.-Nr. **8022**  
ø 25 mm  
5,92 kg



Best.-Nr. **8023**  
ø 25 mm  
5,49 kg



Best.-Nr. **8024**  
ø 28 mm  
6,32 kg



**Vierkanteisen, kantengehämmt**  
**Barreaux quadrangulaires, martelés**  
**Square steel bar, hammered edges**  
**Barra quadrangolare, bordi martellati**  
**Köşe dövmei dörtköşeler**

**Länge / Longueur**  
**Length / Lunghezza / Uzunluk**  
**3000 mm**



Abmessungen /Mesure	kg /m	Best.-Nr.
12x12 mm	1,05	<b>11001</b>
14x14 mm	1,42	<b>11004</b>
16x16 mm	1,85	<b>11002</b>
20x20 mm	2,92	<b>11003</b>
25x25 mm	4,56	<b>11005</b>

**Vierkantrohr, kantengehämmt**  
**Tubes quadrangulaires, martelés**  
**Rectangle tubes, hammered edges**  
**Tubi rettangolari con spigoli martellati**  
**Köşe dövmei profiller**

**Länge / Longueur**  
**Length / Lunghezza / Uzunluk : 3000 mm**



Abmessungen /Mesure	kg /m	Best.-Nr.
20 x 20 x 2,0 mm	1,00	<b>11500</b>
25 x 25 x 2,0 mm	1,33	<b>11511</b>
30 x 20 x 2,0 mm	1,33	<b>11501</b>
30 x 30 x 2,5 mm	2,10	<b>11502</b>
40 x 20 x 2,5 mm	2,10	<b>11503</b>
40 x 30 x 2,5 mm	2,33	<b>11504</b>
40 x 40 x 2,5 mm	2,83	<b>11505</b>
50 x 30 x 2,5 mm	2,83	<b>11506</b>
60 x 40 x 2,5 mm	3,77	<b>11507</b>
60 x 60 x 2,5 mm	5,30	<b>11508</b>
80 x 80 x 3,0 mm	7,00	<b>11509</b>
100 x 100 x 3,5 mm	8,60	<b>11510</b>

Spießkantig abgehämmt, somit absolut keine scharfen Kanten!

**Tubes quadrangulaires : Bords adoucis!**  
**Rectangle tubes: No sharp edges!**  
**Tubi rettangolari: Spigoli smussati!**  
**Keskin olmayan dört köşe demirler**

**Bundeisen und Stangenware / Colliers et barreaux**  
**Collars and bars / Collari e barre / Bilezik ve Çubuklar**

**Handlauf / Main courante**  
**Handrail / Corrimano / Lamalar**

**Länge / Longueur**  
**Length / Lunghezza / Uzunluk**  
**Abmessung / Dimension**  
**Dimension / Dimension / Ölçü**  
**Best.-Nr.**

**Länge / Longueur / Length / Lunghezza / Uzunluk: 3000 mm**

**Abmessung / Dimension**  
**Dimension / Dimension / Ölçü**  
**kg/m**  
**Best.-Nr.**

	Bundeisen	2500 mm	12 x 3 mm	<b>11300</b>
	Bundeisen	2500 mm	16 x 3 mm	<b>11301</b>
	Bundeisen	3000 mm	13 x 3 mm	<b>11302</b>
	Bundeisen	4000 mm	16 x 5 mm	<b>11303</b>
	Vierkanteisen, gerillt 1,05 kg/m	3000 mm	12 x 12 mm	<b>11202</b>
	Flacheisen beidseitig gerillt 0,94 kg/m	3000 mm	16 x 8 mm	<b>11201</b>
	Flacheisen beidseitig abgehämmt 0,92 kg/m	3000 mm	16 x 8 mm	<b>11101</b>
	Flacheisen, gerillt, beidseitig abgehämmt 2,18 kg/m	3000 mm	30 x 10 mm	<b>11102</b>

	40 x 8 mm	2,05	<b>7030</b>
--	-----------	------	-------------

	30 x 8 mm	1,77	<b>7003</b>
	40 x 8 mm	2,35	<b>7004</b>
	50 x 5 mm	1,83	<b>11011</b>
	50 x 8 mm	2,93	<b>7036</b>

	20 x 8 mm	1,18	<b>7001</b>
	25 x 8 mm	1,47	<b>7028</b>
	40 x 5 mm	1,46	<b>11010</b>
	40 x 8 mm	2,35	<b>7002</b>

**Hespeneisen / U-Fer / U-Iron / U-Ferro / U-Demir**



Länge / Longueur	Material / Matériau	Best.-Nr.
Length / Lunghezza	Material / Materiale	
Uzunluk /mm	Malzeme	
3000	25 x 8 mm	<b>11012</b>
3000	30 x 8 mm	<b>11013</b>

**Handlaufzubehör ohne Rillen / Accessoires de main-courante sans rainure**  
**Handrail accessories, not grooved / Accessori per corrimano, martellati, non scanalati**  
**Dövmeli küpeşte aksesuarları**



**Handlauf-Anfang**  
**Best.-Nr. 7017**  
 400 x 150 mm  
 1,65 kg



**Handlauf-Anfang**  
**Best.-Nr. 7006**  
 730 x 150 mm  
 2,20 kg



**Handlauf-Anfang**  
**Best.-Nr. 7016**  
 750 x 320 mm  
 2,30 kg



**Krümmer**  
 290 x 290 mm

**Best.-Nr. 7008**  
 20 x 8 mm, 0,60 kg

**Best.-Nr. 7029**  
 25 x 8 mm, 0,75 kg

**Best.-Nr. 7009**  
 40 x 8 mm, 1,20 kg



**Handlauf-Anfang**  
**Best.-Nr. 7007**  
 250 x 115 mm  
 Aus 40 x 8 mm,  
 0,90 kg



**Handlauf-Anfang**  
**Best.-Nr. 7026**  
 140 x 60 mm  
 Aus 40 x 8 mm,  
 0,47 kg

**Handlaufzubehör mit Rillen / Accessoire de main-courante avec rainure**  
**Grooved handrail termination / Accessorio lavorato per corrimano**  
**Yarmalı küpeşte sonlandırıcısı**



**Handlauf-Anfang**  
**Best.-Nr. 7019**  
 400 x 150 mm  
 1,65 kg



**Handlauf-Anfang**  
**Best.-Nr. 7018**  
 750 x 320 mm  
 2,30 kg



**Handlauf-Anfang**  
**Best.-Nr. 7010**  
 Aus 40 x 8 mm  
 730 x 150 mm, 2,20 kg

**Best.-Nr. 7038**  
 Aus 50 x 8 mm  
 730 x 150 mm, 2,75 kg



**Handlauf-Anfang**  
**Best.-Nr. 7011**  
 Aus 40 x 8 mm,  
 0,90 kg

**Best.-Nr. 7037**  
 Aus 50 x 8 mm,  
 1,13 kg



**Handlauf-Ende**  
**Best.-Nr. 7027**  
 140 x 60 mm  
 Aus 40 x 8 mm,  
 0,47 kg

**Best.-Nr. 7035**  
 Aus 50 x 8 mm,  
 0,60 kg



**Krümmer**  
 290 x 290 mm  
**Best.-Nr. 7013**  
 Aus 30 x 8 mm,  
 0,9 kg

**Best.-Nr. 7014**  
 Aus 40 x 8 mm,  
 1,20 kg

**Handlaufzubehör mit Rillen**  
**Accessoire de main-courante avec rainure**  
**Grooved handrail termination**  
**Accessorio lavorato per corrimano**  
**Yarmalı küpeşte sonlandırıcısı**



**Handlauf-Anfang**  
**Best.-Nr. 7031**  
 250 x 115 mm  
 0,80 kg



**Krümmer**  
**Best.-Nr. 7033**  
 Aus 40 x 8 mm  
 290 x 290 mm  
 1,06 kg



**Handlauf-Anfang**  
**Best.-Nr. 7032**  
 730 x 150 mm  
 1,94 kg

**Handlaufzubehör**  
**Support de main-courante / Handrail bracket**  
**Supporto per corrimano / Duvar kolçağı**

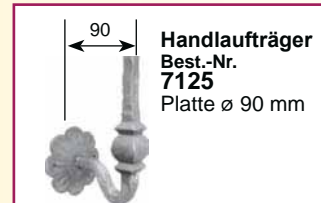

**Handlaufträger**  
**Best.-Nr. 7125**  
 Platte ø 90 mm



**Handlaufträger**  
**Best.-Nr. 7126**  
 Platte ø 90 mm



**Handlaufträger**  
**Best.-Nr. 7122**  
 110 x 190 mm  
 0,52 kg



**Handlaufträger**  
**Best.-Nr. 7123**  
 gehämmert / martelé  
 hammered / martellato  
 dövmeli  
 ø 80 mm

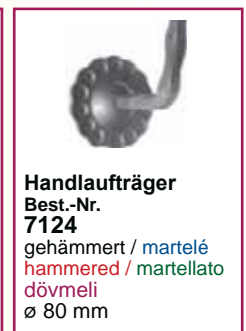

**Handlaufträger**  
**Best.-Nr. 7124**  
 gehämmert / martelé  
 hammered / martellato  
 dövmeli  
 ø 80 mm



**Korbstab aus 12x12 mm**  
glatt / lisse / plain / piatto / düz  
Ausbauchung / Renflement  
Belly / Concavo / Derinlik 180 mm

Länge/mm	Best.-Nr.
900	4001
1350	4002
1500	4003

**Korbstab aus 12x12 mm**  
gehämmert / martelé / hammered / martellato / dövme- Ausbauchung / Renflement  
Belly / Concavo / Derinlik 180 mm

Länge/mm	Best.-Nr.
900	4101
1350	4102
1500	4103



**Korbstab aus 12x12 mm**  
glatt / lisse / plain / piatto / düz  
Ausbauchung / Renflement  
Belly / Concavo / Derinlik 180 mm

Länge/mm	Best.-Nr.
900	4016
1350	4017
1500	4018

**Korbstab aus 12x12 mm**  
gehämmert / martelé / hammered / martellato / dövme- Ausbauchung / Renflement  
Belly / Concavo / Derinlik 180 mm

Länge/mm	Best.-Nr.
900	4116
1350	4117
1500	4118



**Korbstab aus 12x12 mm**  
glatt / lisse / plain / piatto / düz  
Ausbauchung / Renflement  
Belly / Concavo / Derinlik 180 mm

Länge/mm	Best.-Nr.
900	4022
1350	4023
1500	4024

**Korbstab aus 12x12 mm**  
gehämmert / martelé / hammered / martellato / dövme- Ausbauchung / Renflement  
Belly / Concavo / Derinlik 180 mm

Länge/mm	Best.-Nr.
900	4122
1350	4123
1500	4124



**Korbstab aus 12x12 mm**  
glatt / lisse / plain / piatto / düz  
Ausbauchung / Renflement  
Belly / Concavo / Derinlik 180 mm

Länge/mm	Best.-Nr.
900	4028
1350	4029
1500	4030

**Korbstab aus 12x12 mm**  
gehämmert / martelé / hammered / martellato / dövme- Ausbauchung / Renflement  
Belly / Concavo / Derinlik 180 mm

Länge/mm	Best.-Nr.
900	4128
1350	4129
1500	4130



**Korbstab aus 12x12 mm**  
glatt / lisse / plain / piatto / düz  
Ausbauchung / Renflement  
Belly / Concavo / Derinlik 200 mm

Länge/mm	Best.-Nr.
1000	4050
1350	4051
1500	4052

**Korbstab aus 12x12 mm**  
gehämmert / martelé / hammered / martellato / dövme- Ausbauchung / Renflement  
Belly / Concavo / Derinlik 200 mm

Länge/mm	Best.-Nr.
1000	4150
1350	4151
1500	4152



**Korbstab aus 12x12 mm**  
glatt / lisse / plain / piatto / düz  
Ausbauchung / Renflement  
Belly / Concavo / Derinlik 130 mm

Länge/mm	Best.-Nr.
900	4031
1350	4032
1500	4033

**Korbstab aus 12x12 mm**  
gehämmert / martelé / hammered / martellato / dövme- Ausbauchung / Renflement  
Belly / Concavo / Derinlik 130 mm

Länge/mm	Best.-Nr.
900	5553
1350	5554
1500	5555



**Korbstab aus 12x12 mm**  
glatt / lisse / plain / piatto / düz  
Ausbauchung / Renflement  
Belly / Concavo / Derinlik 180 mm

Länge/mm	Best.-Nr.
900	4013
1350	4014
1500	4015



**AK FER**

**Korbstab aus 12x12 mm**  
glatt / lisse / plain / piatto / düz  
Ausbauchung / Renflement  
Belly / Concavo / Derinlik 180 mm

Länge/mm	Best.-Nr.
900	4004
1350	4005
1500	4006



## Korbstäbe & Zubehör / Barreaux galbés et accessoires Convex bars & Accessories / Barre piegata e accessori / Cumbalar & Aksesuarlar



**Korbstab aus 12x12 mm**  
Ausbauchung / Renflement  
Belly / Concavo / Derinlik 110 mm

	Best.-Nr.
glatt	4060
gehämmert	4160



**Best.-Nr. 4075**  
Aus 25 x 8 mm  
900 mm



**Best.-Nr. 4070**  
Aus 12 x 12 mm  
900 mm

**Best.-Nr. 4071**  
Aus 14 x 14 mm  
900 mm

**Best.-Nr. 4072**  
Aus 14 x 14 mm  
1500 mm



**Best.-Nr. 4073**  
Aus 14 x 14 mm  
900 mm

**Best.-Nr. 4074**  
Aus 14 x 14 mm  
1500 mm



**Best.-Nr. 6174**  
Aus 14 x 14 mm  
70 x 140 mm  
gehämmert  
martelé  
hammered  
martellato  
dövmeli



**Best.-Nr. 6074**  
Aus 14 x 14 mm  
70 x 140 mm  
glatt  
lisse  
plain  
piatto  
düz



**Best.-Nr. 6077**  
Aus 14 x 14 mm  
70 x 140 mm



**Best.-Nr. 6076**  
Aus 30 x 8 mm  
70 x 100 mm



**Best.-Nr. 6175**  
45 x 135 mm, Mat. 10 mm  
**Best.-Nr. 6176**  
60 x 175 mm, Mat. 10 mm

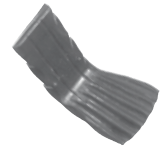

**Best.-Nr. 6075**  
Aus 40 x 8 mm, 70 x 100 mm  
Gerillt / Rainure sur la tranche  
Grooved / Scanalato / Yarmali

**Best.-Nr. 6099**  
Aus 40 x 8 mm, 70 x 100 mm  
ohne Rillen / sans rainure  
not grooved / Senza scanalatura  
Düz

## AK FER

## Locheisen / Barreaux avec trous forgés Bars with holes / Barre forate / Delikli traversler

ca. 2000 mm, 14 Loch/Stange / ca. 2000 mm, 14 Trous/Barre  
approx. 2000 mm, 14 Hole/Bar / circa 2000 mm, Barra forata con 14 fori / 14 delikli yaklaşık 2000 mm.lik çubuk

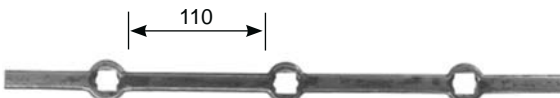

**Best.-Nr. 11410-14** ■ 14 mm, Lochung □ 14 mm  
**Best.-Nr. 11410-20** ■ 20 mm, Lochung □ 20 mm

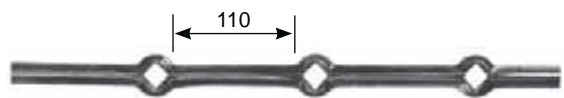

**Best.-Nr. 11412-14** ◆ 14 mm, Lochung □ 14 mm  
**Best.-Nr. 11412-20** ◆ 20 mm, Lochung □ 20 mm

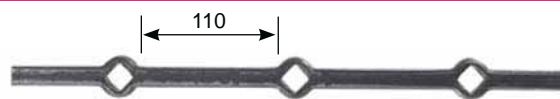

**Best.-Nr. 11411-14** ■ 14 mm, Lochung □ 14 mm  
**Best.-Nr. 11411-20** ■ 20 mm, Lochung □ 20 mm



**Best.-Nr. 11413-14** ● 14 mm, Lochung ○ 14 mm  
**Best.-Nr. 11413-20** ● 20 mm, Lochung ○ 20 mm



Best.-Nr.  
**9014**  
■ 24 mm  
30 x 125 mm



Best.-Nr.  
**9011**  
Ø 30 mm  
35 x 120 mm



Best.-Nr.  
**9025**  
Ø 20 mm  
70 x 125 mm



Best.-Nr.  
**9005**  
60 x 125 mm

Ø 20 mm  
Ø 13 mm



Best.-Nr.  
**9008**  
60 x 125 mm

Ø 20 mm  
Ø 13 mm



Best.-Nr.  
**9029**  
50 x 150 mm



Best.-Nr.  
**9015**  
■ 32 mm  
165 mm



Best.-Nr.  
**9012**  
Ø 33 mm  
40 x 150 mm



Best.-Nr.  
**9026**  
Ø 25 mm  
90 x 160 mm



Best.-Nr.  
**9006**  
70 x 160 mm

Ø 25 mm  
Ø 17 mm



Best.-Nr.  
**9009**  
70 x 160 mm

Ø 25 mm  
Ø 17 mm



Best.-Nr.  
**9028**  
60 x 175 mm



Best.-Nr.  
**9027**  
65 x 200 mm



Best.-Nr.  
**9020**  
Aus ø 12 mm

Best.-Nr.  
**9021**  
Aus 12 x 12 mm

Best.-Nr.  
**9022**  
Aus 12 x 12 mm  
gehämmert  
martelé  
hammered  
martellato  
dövmeli  
30 x 175 mm



Best.-Nr.  
**9016**  
Aus ø 12 mm

Best.-Nr.  
**9017**  
Aus 12 x 12 mm

Best.-Nr.  
**9023**  
Aus 12 x 12 mm  
gehämmert  
martelé  
hammered  
martellato  
dövmeli  
35 x 150 mm



Best.-Nr.  
**9001**  
Aus ø 12 mm

Best.-Nr.  
**9002**  
Aus 12 x 12 mm

Best.-Nr.  
**9003**  
Aus 12 x 12 mm  
gehämmert  
martelé  
hammered  
martellato  
dövmeli  
35 x 150 mm



Best.-Nr.  
**9018**  
Aus ø 12 mm

Best.-Nr.  
**9019**  
Aus 12 x 12 mm

Best.-Nr.  
**9024**  
Aus 12 x 12 mm  
gehämmert  
martelé  
hammered  
martellato  
dövmeli  
35 x 150 mm



Best.-Nr. **9301**  
Ø 12 mm, 100 cm  
Best.-Nr. **9302**  
Ø 12 mm, 150 cm  
Best.-Nr. **9303**  
12 x 12 mm, 100 cm  
Best.-Nr. **9304**  
12 x 12 mm, 150 cm

Best.-Nr. **9305**  
12 x 12 mm, 100 cm  
gehämmert / martelé  
hammered / martellato dövmeli

Best.-Nr. **9306**  
12 x 12 mm, 150 cm  
gehämmert / martelé  
hammered / martellato dövmeli



Best.-Nr. **9307**  
ø 12 mm, 100 cm  
Best.-Nr. **9308**  
ø 12 mm, 150 cm  
Best.-Nr. **9309**  
12 x 12 mm, 100 cm  
Best.-Nr. **9310**  
12 x 12 mm, 150 cm

Best.-Nr. **9323**  
12 x 12 mm, 100 cm  
gehämmert / martelé  
hammered / martellato dövmeli

Best.-Nr. **9324**  
12 x 12 mm, 150 mm  
gehämmert / martelé  
hammered / martellato dövmeli



Best.-Nr. **9311**  
ø 12 mm, 100 cm  
Best.-Nr. **9312**  
ø 12 mm, 150 cm  
Best.-Nr. **9313**  
12 x 12 mm, 100 cm  
Best.-Nr. **9314**  
12 x 12 mm, 150 cm

Best.-Nr. **9315**  
12 x 12 mm, 100 cm  
gehämmert / martelé  
hammered / martellato dövmeli

Best.-Nr. **9316**  
12 x 12 mm, 150 mm  
gehämmert / martelé  
hammered / martellato dövmeli



Best.-Nr. **9317**  
ø 12 mm, 100 cm  
Best.-Nr. **9318**  
ø 12 mm, 150 cm  
Best.-Nr. **9319**  
12 x 12 mm, 100 cm  
Best.-Nr. **9320**  
12 x 12 mm, 150 cm

Best.-Nr. **9321**  
12 x 12 mm, 100 cm  
gehämmert / martelé  
hammered / martellato dövmeli

Best.-Nr. **9322**  
12 x 12 mm, 150 cm  
gehämmert / martelé  
hammered / martellato dövmeli

## AK FER

### Rosetten / Rosettes forgées Forged rosettes / Rosette in ferro / Ferforje rozetler

<b>65 x 65 mm,</b> Material 4 mm	Best.-Nr.
ohne Loch	<b>10809</b>
mit Loch 12x12 mm	<b>10810</b>
mit Loch 16x16 mm	<b>10811</b>
mit Loch 20x20 mm	<b>10812</b>



<b>ø 80 mm,</b> Material 4 mm	Best.-Nr.
ohne Loch	<b>10823</b>
mit Loch 12x12 mm	<b>10824</b>
mit Loch 16x16 mm	<b>10825</b>
mit Loch 20x20 mm	<b>10826</b>
mit Loch 24x24 mm	<b>10827</b>



<b>80x80 mm,</b> Material 4 mm	Best.-Nr.
ohne Loch	<b>10813</b>
mit Loch 12x12 mm	<b>10814</b>
mit Loch 16x16 mm	<b>10815</b>
mit Loch 20x20 mm	<b>10816</b>
mit Loch 24x24 mm	<b>10817</b>



<b>100 x 100 mm,</b> Material 6 mm	Best.-Nr.
ohne Loch	<b>10818</b>

<b>100 x 100 mm,</b> Material 8 mm	Best.-Nr.
ohne Loch	<b>10819</b>

Best.-Nr. <b>10829</b> ø 65 mm Material 3 mm	Best.-Nr. <b>10828</b> ø 65 mm Material 3 mm	Best.-Nr. <b>10831</b> ø 130 mm Material 4 mm	Best.-Nr. <b>10830</b> ø 80 mm Material 2,5 mm
---	---	--	---

## AK FER

### Schmiedestücke & Zierteile / Accessoires en fer forgé Forgings & Accessories / Ferro battuto & Accessori / Dövme parçalar



Best.-Nr.  
**9202**  
rund



Best.-Nr.  
**9203**  
eckig



Best.-Nr.  
**9204**



Best.-Nr.  
**9205**



Best.-Nr.  
**6013**  
Aus 12 x 12 mm  
glatt / lisse  
plain / piatto / düz  
Länge 290 mm



Best.-Nr.  
**6113**  
Aus 12 x 12 mm  
gehämmert  
martelé  
hammered  
martellato  
dövmeli  
Länge 290 mm



Best.-Nr.  
**6014**  
Aus 12 x 12 mm  
glatt / lisse  
plain / piatto / düz  
55 x 100 mm



Best.-Nr.  
**6114**  
Aus 12 x 12 mm  
gehämmert / martelé  
hammered / martellato  
dövmeli  
55 x 100 mm



Best.-Nr. **9214**  
Lochung ø 12,5 mm, ø 35 x 25 mm

Best.-Nr. **9215**  
Lochung ø 14,5 mm, ø 35 x 25 mm



Best.-Nr.  
**9210**  
ø 40 x 90 mm



Best.-Nr. **9212**  
Lochung ø 12,5 mm, ø 40 x 68 mm

Best.-Nr. **9213**  
Lochung ø 14,5 mm, ø 40 x 68 mm



Best.-Nr. **9211**  
Lochung  
12,5 x 12,5 mm  
40 x 40 x 70 mm

øD



øD / mm	Gewicht / kg	Best.-Nr.
37	0,15	9206
45	0,50	9207
55	0,80	9208
65	1,40	9209



## AK FER

### Ringen / Anneaux / Rings / Anelli / Halkalar

Verschweisst und sauber verschliffen / Soudé et lissé / Welded and grinded / Saldati e lisciati / Kaynatılıp taşlanmış

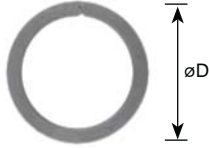

Material ● 12 mm

øD /mm	Best.-Nr.
100	6600
110	6601
120	6602

Material 12 x 12 mm

100	6610
110	6611
120	6612

Material 12 x 6 mm

100	6620
110	6621
120	6622

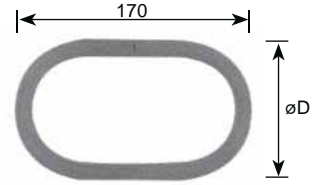

Material ● 12 mm

øD /mm	Best.-Nr.
100	6650
110	6651
120	6652

Material 12 x 12 mm

100	6660
110	6661
120	6662

Material 12 x 6 mm

100	6670
110	6671
120	6672

## AK FER

### Ornamente / Ornaments / Ornements / Oggetti ornamentali / Ornamentler

Material: 12 x 6 mm

**Profiqualität!**



Best.-Nr. 6017  
240 x 240 mm

Best.-Nr. 6018  
300 x 300 mm

Material: 12 x 6 mm

**Profiqualität!**



Best.-Nr. 6053  
240 x 240 mm

Best.-Nr. 6054  
300 x 300 mm



Best.-Nr.  
6042  
150 x 270 mm



Best.-Nr.  
6043  
120 x 210 mm



Best.-Nr.  
6044  
120 x 210 mm



Best.-Nr.  
6045  
100 x 120 mm



Best.-Nr.  
6049  
Zwirbel 20



Best.-Nr.  
6048  
Zwirbel 12

AK

FER

Ornamente / Ornaments / Ornamenti / Oggetti ornamentali / Ornamentler

Ornament 650 x 450 mm



- Best.-Nr. 9400 aus  $\varnothing$  12 mm, 3,50 kg  
glatt / plain  
lisse / piatto / düz
- Best.-Nr. 9401 aus 16 x 8 mm, 3,75 kg  
gehämmert / martelé  
hammered / martellato / dövme
- Best.-Nr. 9402 aus 16 x 8 mm, 3,75 kg  
gerillt / rainure sur la tranche  
grooved / scanalato / yarmalı

Ornament 710 x 710 mm



- Best.-Nr. 9410 aus  $\varnothing$  12 mm, 3,25 kg  
glatt / plain  
lisse / piatto / düz
- Best.-Nr. 9411 aus 16 x 8 mm, 3,50 kg  
gehämmert / martelé  
hammered / martellato / dövme
- Best.-Nr. 9412 aus 16 x 8 mm, 3,50 kg  
gerillt / rainure sur la tranche  
grooved / scanalato / yarmalı

Ornament 615 x 775 mm



- Best.-Nr. 9406 aus  $\varnothing$  12 mm, 6,20 kg  
glatt / plain  
lisse / piatto / düz
- Best.-Nr. 9407 aus 16 x 8 mm, 6,87 kg  
gehämmert / martelé  
hammered / martellato / dövme
- Best.-Nr. 9408 aus 16 x 8 mm, 6,87 kg  
gerillt / rainure sur la tranche  
grooved / scanalato / yarmalı

Ornament 500 x 450 mm



- Best.-Nr. 9403 aus 12 x 6 mm, 5,88 kg  
glatt / plain  
lisse / piatto / düz



Best.-Nr. **12007**  
155 x 60 mm  
Material 3 mm



Best.-Nr. **12008**  
155 x 60 mm  
Material 3 mm



Best.-Nr. **12035**  
Rosenblatt  
32 x 47 mm  
Material 1 mm



Best.-Nr. **12009**  
95 x 115 mm  
Material 3 mm



Best.-Nr. **12010**  
95 x 115 mm  
Material 3 mm



Best.-Nr. **12003**  
80 x 85 mm  
Material 3 mm



Best.-Nr. **12004**  
80 x 85 mm  
Material 3 mm



Best.-Nr. **12005**  
110 x 40 mm  
Material 3 mm



Best.-Nr. **12006**  
110 x 40 mm  
Material 3 mm

Best.-Nr. **12036**  
Länge ca.  
340 mm



Best.-Nr. **12037**  
Länge ca.  
200 mm



Best.-Nr. **12029**  
125 x 85 mm  
Material 3 mm



Best.-Nr. **12031**  
200 x 95 mm  
Material 6 mm



Best.-Nr. **12032**  
205 x 100 mm  
Material 3 mm



Best.-Nr. **12033**  
160 x 60 mm  
Material 3 mm



Best.-Nr. **12013**  
60 x 70 mm  
Material 3 mm



Best.-Nr. **12012**  
60 x 70 mm  
Material 3 mm



Best.-Nr. **12038**  
75 x 85 mm  
Material 3 mm



Best.-Nr. **12017**  
200 x 140 mm  
Material 6 mm



Best.-Nr. **12018**  
200 x 140 mm  
Material 6 mm



Best.-Nr. **12019**  
200 x 130 mm  
Material 6 mm



Best.-Nr. **12020**  
200 x 130 mm  
Material 6 mm



Best.-Nr. **12039**  
Weintraube  
ca. 85 x 65 mm



Best.-Nr. **12040**  
Weintraube  
ca. 55 x 65 mm



Best.-Nr. **12030**  
310 x 260 mm  
Material 6 mm



Best.-Nr. **12027**  
200 x 135 mm  
Material 3 mm



Best.-Nr. **12028**  
200 x 135 mm  
Material 3 mm



Best.-Nr. **12024**  
110 x 80 mm  
Material 3 mm



Best.-Nr. **12025**  
110 x 80 mm  
Material 3 mm



Best.-Nr. **12014**  
415 x 185 mm  
Material 6 mm



Best.-Nr. **12015**  
415 x 185 mm  
Material 6 mm



Best.-Nr. **12041**  
ca. 165x 110 mm



Best.-Nr. **12034**  
Pfosten-Krone  
90 x 170 mm



Best.-Nr. **12022**  
210 x 135 mm  
Material 6 mm



Best.-Nr. **12023**  
210 x 135 mm  
Material 6 mm

Neu  
Novelty - New - Nispeten



**Stichbogen**  
**Profil voué**  
**Low profile vault**  
**Lungo profilo leggermente arcuato**  
**Kemer**

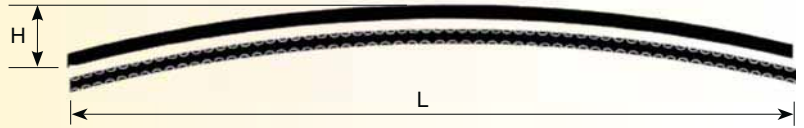

Glatt / Lisse / Plain / Piatto / Düz

L/mm	H/mm	Best.-Nr.	Material
4000 mm	200 mm	10042	30x30x2,5
4000 mm	200 mm	10043	40x20x2,5
4000 mm	200 mm	10044	40x30x2,5
4000 mm	200 mm	10045	40x40x2,5
4000 mm	200 mm	10046	50x30x2,5
4000 mm	200 mm	10047	60x40x2,5
3000 mm	200 mm	10005	30x30x2,5
3000 mm	200 mm	10050	40x20x2,5
3000 mm	200 mm	10051	40x30x2,5
3000 mm	200 mm	10004	40x40x2,5
3000 mm	200 mm	10052	50x30x2,5
3000 mm	200 mm	10006	60x40x2,5
2000 mm	200 mm	10055	30x30x2,5
2000 mm	200 mm	10056	40x20x2,5
2000 mm	200 mm	10057	40x30x2,5
2000 mm	200 mm	10058	40x40x2,5
2000 mm	200 mm	10059	50x30x2,5
2000 mm	200 mm	10060	60x40x2,5
1000 mm	150 mm	10023	30x30x2,5
1000 mm	150 mm	10063	40x20x2,5
1000 mm	150 mm	10064	40x30x2,5
1000 mm	150 mm	10003	40x40x2,5
1000 mm	150 mm	10065	50x30x2,5
1000 mm	150 mm	10066	60x40x2,5

Kantengehämmert / Martelé  
 Hammered edges / Bordi martellati / Köşe dövme

L/mm	H/mm	Best.-Nr.	Material
4000 mm	200 mm	10142	30x30x2,5
4000 mm	200 mm	10143	40x20x2,5
4000 mm	200 mm	10144	40x30x2,5
4000 mm	200 mm	10145	40x40x2,5
4000 mm	200 mm	10146	50x30x2,5
4000 mm	200 mm	10147	60x40x2,5
3000 mm	200 mm	10104	30x30x2,5
3000 mm	200 mm	10150	40x20x2,5
3000 mm	200 mm	10151	40x30x2,5
3000 mm	200 mm	10105	40x40x2,5
3000 mm	200 mm	10152	50x30x2,5
3000 mm	200 mm	10106	60x40x2,5
2000 mm	200 mm	10155	30x30x2,5
2000 mm	200 mm	10156	40x20x2,5
2000 mm	200 mm	10157	40x30x2,5
2000 mm	200 mm	10158	40x40x2,5
2000 mm	200 mm	10159	50x30x2,5
2000 mm	200 mm	10160	60x40x2,5
1000 mm	150 mm	10123	30x30x2,5
1000 mm	150 mm	10163	40x20x2,5
1000 mm	150 mm	10164	40x30x2,5
1000 mm	150 mm	10103	40x40x2,5
1000 mm	150 mm	10165	50x30x2,5
1000 mm	150 mm	10166	60x40x2,5

**Geschweiffter Bogen**  
**Profil voué avec extrémités horizontales**  
**Low profile vault with horizontal edge**  
**Lungo profilo leggermente arcuato, con estremi orizzontali**  
**Uçları düz kemer**



Glatt / Lisse / Plain / Piatto / Düz

L/mm	H/mm	Best.-Nr.	Material
4000 mm	200 mm	10072	30x30x2,5
4000 mm	200 mm	10073	40x20x2,5
4000 mm	200 mm	10074	40x30x2,5
4000 mm	200 mm	10075	40x40x2,5
4000 mm	200 mm	10076	50x30x2,5
4000 mm	200 mm	10077	60x40x2,5
3000 mm	200 mm	10010	30x30x2,5
3000 mm	200 mm	10080	40x20x2,5
3000 mm	200 mm	10081	40x30x2,5
3000 mm	200 mm	10011	40x40x2,5
3000 mm	200 mm	10082	50x30x2,5
3000 mm	200 mm	10012	60x40x2,5
2000 mm	200 mm	10085	30x30x2,5
2000 mm	200 mm	10086	40x20x2,5
2000 mm	200 mm	10087	40x30x2,5
2000 mm	200 mm	10088	40x40x2,5
2000 mm	200 mm	10089	50x30x2,5
2000 mm	200 mm	10090	60x40x2,5

Kantengehämmert / Martelé  
 Hammered edges / Bordi martellati / Köşe dövme

L/mm	H/mm	Best.-Nr.	Material
4000 mm	200 mm	10172	30x30x2,5
4000 mm	200 mm	10173	40x20x2,5
4000 mm	200 mm	10174	40x30x2,5
4000 mm	200 mm	10175	40x40x2,5
4000 mm	200 mm	10176	50x30x2,5
4000 mm	200 mm	10177	60x40x2,5
3000 mm	200 mm	10110	30x30x2,5
3000 mm	200 mm	10180	40x20x2,5
3000 mm	200 mm	10181	40x30x2,5
3000 mm	200 mm	10111	40x40x2,5
3000 mm	200 mm	10182	50x30x2,5
3000 mm	200 mm	10112	60x40x2,5
2000 mm	200 mm	10185	30x30x2,5
2000 mm	200 mm	10186	40x20x2,5
2000 mm	200 mm	10187	40x30x2,5
2000 mm	200 mm	10188	40x40x2,5
2000 mm	200 mm	10189	50x30x2,5
2000 mm	200 mm	10190	60x40x2,5

**Rundbogen / Arc demi-cercle / Semi ring vault / Arco a semicerchio / Yarım daire kemer**

Glatt / Lisse / Plain / Piatto / Düz

Länge	Best.-Nr.	Aus
900 mm	10001	30x30x2,5
900 mm	10022	40x20x2,5
900 mm	10024	40x30x2,5
900 mm	10025	40x40x2,5
900 mm	10026	50x30x2,5
900 mm	10027	60x40x2,5
1000 mm	10002	30x30x2,5
1000 mm	10030	40x20x2,5
1000 mm	10031	40x30x2,5
1000 mm	10032	40x40x2,5
1000 mm	10033	50x30x2,5
1000 mm	10034	60x40x2,5

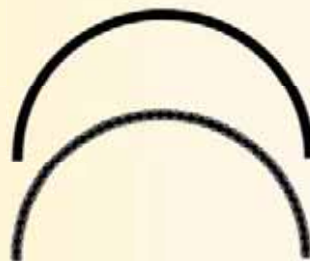

Sonderabmessungen auf anfrage  
 Dimensions spéciales sur demande  
 Special sizes of products on demand  
 Misure speciali su richiesta

Kantengehämmert / Martelé  
 Hammered edges / Bordi martellati / Köşe dövme

Länge	Best.-Nr.	Aus
900 mm	10101	30x30x2,5
900 mm	10122	40x20x2,5
900 mm	10124	40x30x2,5
900 mm	10125	40x40x2,5
900 mm	10126	50x30x2,5
900 mm	10127	60x40x2,5
1000 mm	10102	30x30x2,5
1000 mm	10130	40x20x2,5
1000 mm	10131	40x30x2,5
1000 mm	10132	40x40x2,5
1000 mm	10133	50x30x2,5
1000 mm	10134	60x40x2,5

**AK FER**

**Schmiedeeisen-Drückergarnituren / Poignées en fer forgé**  
**Wrought iron handles / Maniglia in ferro battuto / Ferforje kapı kolları**

**Oberfläche**  
galvanisch verzinkt  
lackiert  
gebürstet  
transparent pulverbeschichtet

**Surface**  
galvanisé  
laqué  
brossee  
revêtement par poudre

**Surface**  
zinc plated  
lacquered  
brushed  
powder coated

**Superficie**  
zincato  
laccato  
spazzolato  
verniciato a polvere

**Yüzey**  
elektro galvanizli  
boyalı  
firçalı  
toz boyalı

passend auf Best-Nr 10201

123  
4567  
890  
abcd

Best.-Nr./Code  
10632



Ø 50 mm  
Best.-Nr.  
10629-FU



Ø 50 mm  
Best.-Nr.  
10629-PZ

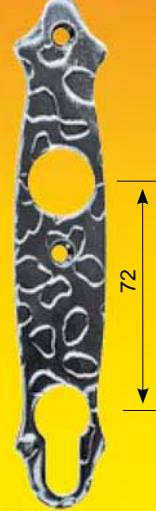

30 x 160 mm  
Best.-Nr. 10622



Best.-Nr.  
10621-R



Best.-Nr.  
10621-L

New - Nuovo - Yeni



Best.-Nr.  
10625-F  
Knopf  
fest/ fix

Best.-Nr.  
10625-D  
Knopf  
drehbar/ non-fix



Best.-Nr.  
10623-R



Best.-Nr.  
10628  
Knopf  
drehbar/ non-fix



Best.-Nr.  
10623-L

Seite / Page / Page / Pagina / Sayfa 87

Beispiele möglicher Kombinationen / Exemples de combinaisons possibles  
Possible combination examples / Possibile combinazione di esempi / Olası kombinasyon örnekleri

Typ 1, 2, 3

Typ 4, 5

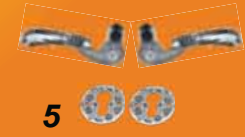

**Schmiedeeisen-Schlossblenden / Plaques de serrure en fer forgé**

**Wrought iron lock plates / Placche per serratura in ferro battuto / Ferforje aynalar**

E = 72 mm, A = 60 mm

E = 72 mm, A = 40 mm

E = 72 mm, A = 60 mm

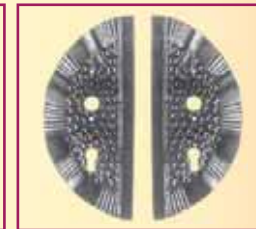
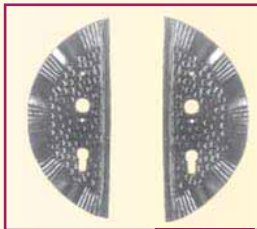
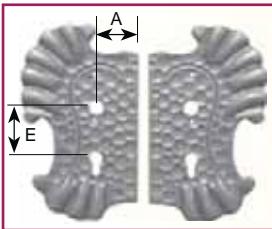

Best.-Nr.  
10407  
275x160 mm  
0,72 kg

Best.-Nr.  
10408  
275x160 mm  
0,72 kg

Best.-Nr.  
10409  
275x160 mm  
0,75 kg

Best.-Nr.  
10410  
275x160 mm  
0,75 kg

Best.-Nr.  
10401  
120x290 mm  
0,61 kg

Best.-Nr.  
10402  
120x290 mm  
0,61 kg

Best.-Nr.  
10403  
120x290 mm  
0,64 kg

Best.-Nr.  
10404  
130x290 mm  
0,67 kg

Best.-Nr.  
10405  
130x290 mm  
0,67 kg

Best.-Nr.  
10406  
130x290 mm  
0,70 kg

E-mail: bilgi@yapimetal.net, www.yapimetal.net

Telefon: (312) 385 48 06 - Belgegeçer: (312) 385 42 16



Für/ for/ pour	L x t	Best.-Nr.
M18	75 x 40	10513
M22	85 x 46	10514



Für/ for/ pour	Best.-Nr.
M18	10519
M22	10520

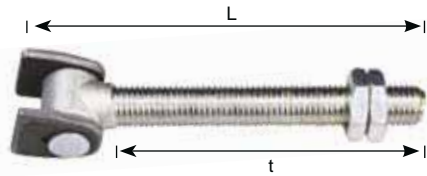

Für/ for/ pour	L x t	Best.-Nr.
M20	175 x 142	10517
M24	186 x 155	10518



øD /mm	L /mm	Best.-Nr.
30	150	10501
24	120	10502
20	100	10503



øD /mm	L /mm	Best.-Nr.
30	150	10505
24	120	10506
20	100	10507



øD /mm	L /mm	Best.-Nr.
30	150	10510



øD /mm	Kegel ø/mm	Für/ for/ pour	Best.-Nr.
24	14	M20	10511
30	20	M22	10512



3-teilig mit  
Anschweißhülse  
Auf Wunsch mit Mauerhülse  
erhältlich!

øD /mm	Kegel ø/mm	Für/ for/ pour	Best.-Nr.
24	14	M20	10508
30	20	M22	10509

Torriegel für Hängeschloss / Verrou au sol pour porte  
Door bolt / Chiavistello / Kapı Sürgüsü

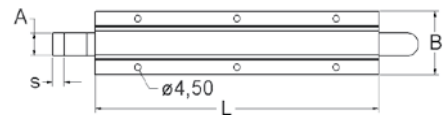

L /mm	B /mm	A /mm	s /mm	Best.-Nr.
200	55	25	8	10740-200

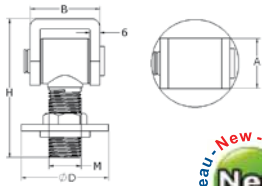

M	øD /mm	H /mm	A /mm	B /mm	Best.-Nr.
M16	53	79,5	30	43	10521-16
M20	66	85,0	30	43	10521-20
M24	65	101	35	49	10521-24

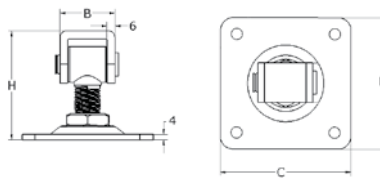

M	H /mm	B /mm	L /mm	C /mm	Best.-Nr.
M16	62-83	43,0	79	79	10523-16
M20	62-90	43,0	100	100	10523-20
M24	68-100	49,3	120	120	10523-24

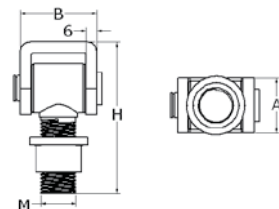

M	H /mm	B /mm	A /mm	Best.-Nr.
M16	78,5	42	30	10522-16
M20	86,0	42	30	10522-20
M24	100,5	46	35	10522-24



**AK FER**

**Schiebetorrollen / Galets / Wheels / Ruote / Makaralar**

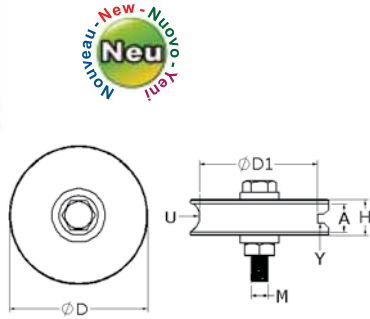

New - Nuovo - Yeni  
**Neu**

Y - Rille / Gorge Y / Y-Groove / Scanalatura a Y / Y-yiv					
øD /mm	H /mm	øD1 /mm	A /mm	M /mm	Best.-Nr.
58	17	44,6	13,6	10	10712-60Y
68	20	51,6	16,0	10	10712-70Y
78	20	61,6	16,5	10	10712-80Y

U - Rille / Gorge U / U-Groove / Scanalatura a U / U-yiv					
øD /mm	H /mm	øD1 /mm	A /mm	M /mm	Best.-Nr.
58	17	49	13,6	10	10712-60U
68	20	57	16,0	10	10712-70U
78	20	68	16,5	10	10712-80U



New - Nuovo - Yeni  
**Neu**

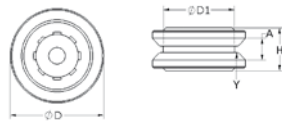

**Schiebetorrolle mit 2 Kugellagern**  
**Galet à 2 roulements / Wheel with 2 bearings**  
**Ruota con doppio sostegno**  
**Çift rulmanlı tekerlek silindiri**

V - Rille / Gorge V / V-Groove / Scanalatura a V / V-yiv				
øD /mm	øD1 /mm	H /mm	A /mm	Best.-Nr.
58	43,00	31	15	10709-60V
68	51,70	31	16	10709-70V
78	61,00	30	17	10709-80V

**Schiebetorrolle mit 2 Kugellagern / Galet à 2 roulements**  
**Wheel with 2 bearings / Ruota con doppio sostegno**  
**Çift rulmanlı tekerlek silindiri**

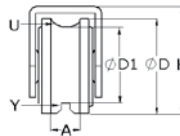

New - Nuovo - Yeni  
**Neu**



U - Rille / Gorge U / U-Groove / Scanalatura a U / U-yiv						
øD /mm	øD1 /mm	H /mm	A /mm	B /mm	C /mm	Best.-Nr.
58	44,6	65	16	44,0	48	10708-60V
68	51,6	79	16	44,5	80	10708-70V
78	61,6	84	16	44,5	80	10708-80V



New - Nuovo - Yeni  
**Neu**

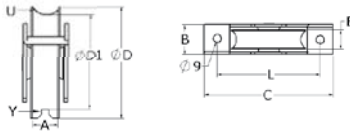

Y - Rille / Gorge Y / Y-Groove / Scanalatura a Y / Y-yiv							
øD /mm	øD1 /mm	A /mm	B /mm	C /mm	E /mm	L /mm	Best.-Nr.
78	61,6	15,5	32	136	20	112,0	10711-80Y
88	70,4	16,0	32	152	21	128,5	10711-90Y
98	79,5	16,5	32	152	22	128,5	10711-100Y

U - Rille / Gorge U / U-Groove / Scanalatura a U / U-yiv							
øD /mm	øD1 /mm	A /mm	B /mm	C /mm	E /mm	L /mm	Best.-Nr.
78	68,0	15,5	32	136	20	112,0	10711-80U
88	77,0	16,0	32	152	21	128,5	10711-90U
98	86,4	16,5	32	152	22	128,5	10711-100U



New - Nuovo - Yeni  
**Neu**

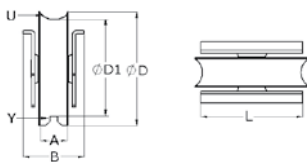

Y - Rille / Gorge Y / Y-Groove / Scanalatura a Y / Y-yiv					
øD /mm	øD1 /mm	A /mm	B /mm	L /mm	Best.-Nr.
58	44,6	14,0	39	59	10713-60Y
68	51,6	16,5	39	59	10713-70Y
78	61,6	15,5	41	71	10713-80Y

U - Rille / Gorge U / U-Groove / Scanalatura a U / U-yiv					
øD /mm	øD1 /mm	A /mm	B /mm	L /mm	Best.-Nr.
58	49	14,0	39	59	10713-60U
68	57	16,5	39	59	10713-70U
78	68	15,5	41	71	10713-80U



New - Nuovo - Yeni  
**Neu**

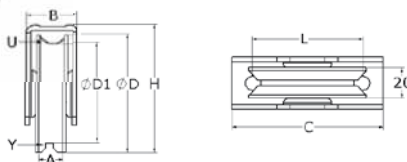

Y - Rille / Gorge Y / Y-Groove / Scanalatura a Y / Y-yiv							
øD /mm	øD1 /mm	H /mm	A /mm	B /mm	C /mm	L /mm	Best.-Nr.
58	44,6	63,80	13,3	27,65	85	55	10710-60Y
68	51,6	79,00	15,3	34,25	100	70	10710-70Y
78	61,6	84,65	15,6	34,40	100	70	10710-80Y
98	79,5	106,00	16,5	36,00	132	105	10710-100Y

U - Rille / Gorge U / U-Groove / Scanalatura a U / U-yiv							
øD /mm	øD1 /mm	H /mm	A /mm	B /mm	C /mm	L /mm	Best.-Nr.
58	49,0	63,80	13,3	27,65	85	55	10710-60U
68	57,0	79,00	15,3	34,25	100	70	10710-70U
78	68,0	84,65	15,6	34,40	100	70	10710-80U
98	86,4	106,00	16,5	36,00	132	105	10710-100U

E-mail: [bilgi@yapimetal.net](mailto:bilgi@yapimetal.net), [www.yapimetal.net](http://www.yapimetal.net)

Telefon: (312) 385 48 06 - Belgegeçer: (312) 385 42 16

**AK FER**

**Torführungsbügel / Platinas guides-portails**  
**Drive-gate plates / Piastrre guida per cancelli / Sürgülü kapı plakaları**



Neu  
 Nouveau - New - Nuovo - Yeni

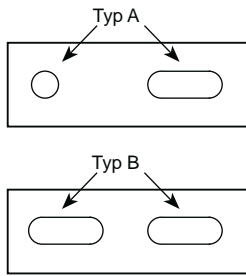
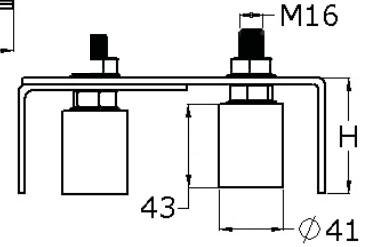
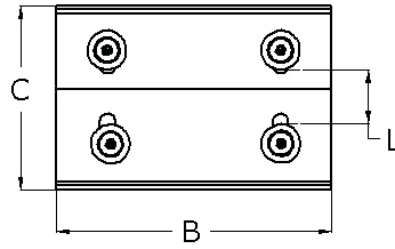

Best.-Nr.	Typ A	Typ B	B /mm	C /mm	L /mm	H /mm	Roller /mm
10724-220-1	X		220	150-210	20-65	55	Ø41 x 43
10724-220-1		X	220	135-180	30-75	55	Ø41 x 43
10724-220-2	X		220	115-180	15-65	55	Ø31 x 43
10724-220-2		X	220	135-180	30-75	55	Ø31 x 43
10725-290	X		290	170-260	55-100	65	Ø41 x 43
10725-290		X	290	170-260	20-100	65	Ø41 x 43
10725-350	X		350	170-260	55-100	65	Ø41 x 43
10725-350		X	350	170-260	20-100	65	Ø41 x 43



Neu  
 Nouveau - New - Nuovo - Yeni

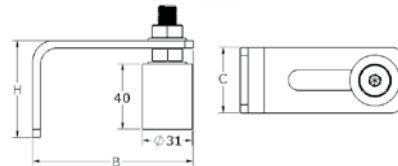
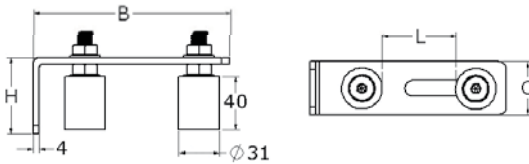

Best.-Nr.	B /mm	L /mm	H /mm	C /mm	Roller /mm
10727-25	150	20-65	55	40	Ø25 x 40
10727-31	150	11-60	55	40	Ø31 x 40

Best.-Nr.	B /mm	H /mm	C /mm	Roller /mm
10726-25	100	60	40	Ø25 x 40
10726-31	100	60	40	Ø31 x 40



Neu  
 Nouveau - New - Nuovo - Yeni

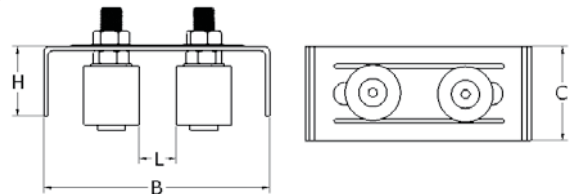

Best.-Nr.	B /mm	L /mm	H /mm	Roller /mm
10723-70	165	30-70	65	Ø41 x 43

**AK FER**

**Türstopper / Butée pour portail coulissant**  
**Stop for sliding gate / Fermo per cancelli scorrevoli / Kapı durdurucuları**

Neu  
 Nouveau - New - Nuovo - Yeni

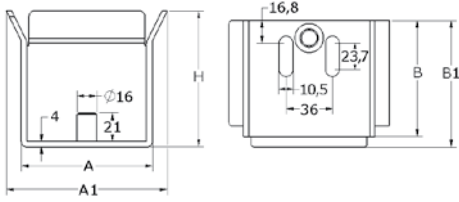

H /mm	A /mm	A1 /mm	B /mm	B1 /mm	Best.-Nr.
98,5	102	137	98	118	10721-100

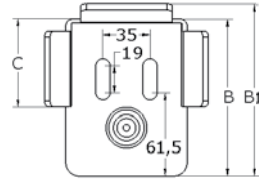
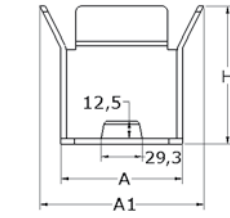

H /mm	A /mm	A1 /mm	B /mm	B1 /mm	Best.-Nr.
80	125	100	65	140	10722-65
80	125	115	85	140	10722-85
105	165	125	100	180	10722-100



Neu  
 Nouveau - New - Nuovo - Yeni

**Oberfläche**  
 Feuerverzinkt  
**Surface** galvanisé  
**Surface** zinc plated  
**Superficie** zincato  
**Yüzey** galvanizli



A /mm	Best.-Nr.
33	10701
43	10702
-	10705

Best.-Nr./Code **10705**  
 ohne riegelsschlitz / *butoir sans fente*  
 without slot / *senza fessura* / *deliksiz*

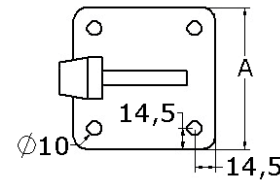
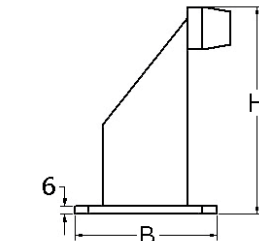

Ax Bx H /mm	Best.-Nr.
100 x 100 x 140	10729



Neu  
 Nouveau - New - Nuovo - Yeni

**AK FER**

**Nylon-Führungsrolle / Cylindre-guidant en nylon**  
**Nylon roller / Cilindri in nylon / Nylon silindir**



Neu  
 Nouveau - New - Nuovo - Yeni

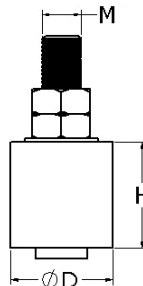

øD x H /mm	M	Best.-Nr.
41 x 43	16	10720-4140B

øD x H /mm	M	Best.-Nr.
25 x 40	12	10720-2540W
31 x 40	12	10720-3140W
41 x 43	16	10720-4140W





Schlossgehäuse, Links oder rechts verwendbar, 2-tourig  
Boîtier en inox, Disponible droite et gauche, à 2 tours.  
Lock case, Left or right side usage with 2-tours lock.  
Serratura, Utilizzabile sia a destra che a sinistra, scrocco a doppio giro.  
Kilit Kasası, Sağ ve Sol olarak kullanılabilir, iki türlü kilit ile.

T x H x B /mm	Best.-Nr.
96 x 172 x 30	10201-30
96 x 172 x 34	10201-34
96 x 172 x 40	10201-40
96 x 172 x 50	10201-50

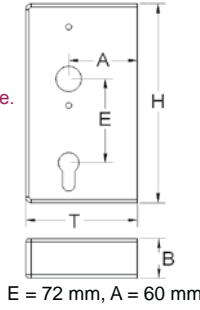

Schlossgehäuse mit Doppelsylinder,  
Links oder rechts verwendbar  
Boîtier en inox, Disponible droite et gauche, à 2 tours.  
Lock case, Left or right side usage with 2-tours lock.  
Serratura, Utilizzabile sia a destra che a sinistra, scrocco a doppio giro.  
Kilit Kasası, Sağ ve Sol olarak kullanılabilir, iki türlü kilit ile.

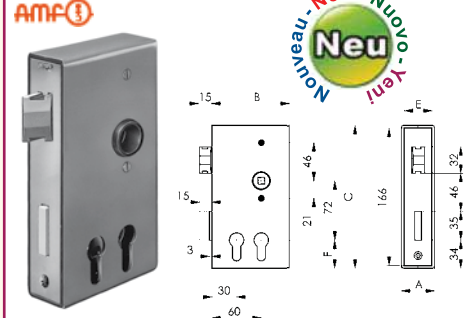

T x H x B /mm	Best.-Nr.
96 x 172 x 30	10201-30-D
96 x 172 x 34	10201-34-D
96 x 172 x 40	10201-40-D
96 x 172 x 50	10201-50-D



Schmales Schlossgehäuse,  
Links oder rechts verwendbar, 1-tourig  
Boîtier de serrure étroit,  
Utilisable droite et gauche, serrure à un tour  
Narrow lock case,  
Left or right side usage with 1-tour lock  
Serratura stretta,  
Utilizzo a destra o sinistra, serratura a giro singolo  
Dar kilit kasası  
Sağ ve sol olarak kullanılabilir, bir türlü kilit ile

T x H x B /mm	Best.-Nr.
65 x 172 x 30	10230
65 x 172 x 40	10230-40

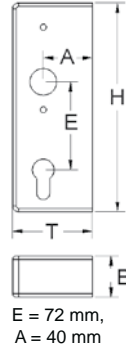

Schlossgehäuse mit Hakenfalle  
Boîtier de serrure à crochet pour porte coulissante  
Lock case for sliding doors with hook  
Serratura per porta scorrevole, ad uncino  
Kilit kasası kancalı kilit ile

T x H x B /mm	Best.-Nr.
96 x 172 x 30	10250-30
96 x 172 x 34	10250-34
96 x 172 x 40	10250-40
96 x 172 x 50	10250-50

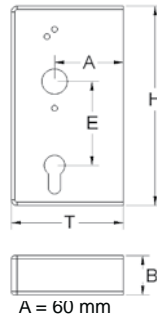

Schlossgehäuse mit Hakenfalle und Doppelsylinder  
Boîtier de serrure à crochet pour porte coulissante  
Lock case for sliding doors with hook  
Serratura per porta scorrevole, ad uncino  
Kilit kasası kancalı kilit ile

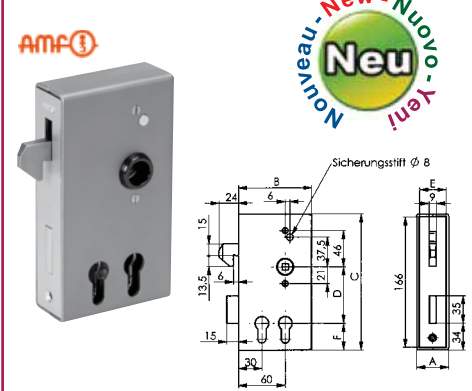

T x H x B /mm	Best.-Nr.
96 x 172 x 30	10250-30-D
96 x 172 x 34	10250-34-D
96 x 172 x 40	10250-40-D
96 x 172 x 50	10250-50-D



Gegenkasten, Gehäuse und Schliessblech  
Gâche, Boîtier et platine de gâche  
Striking case, Lock case and striking plate  
Controbocchetta, Serratura e controbocchetta  
Karşılık kasası, Kasa ve ayna

T x H x B /mm	Best.-Nr.
96 x 172 x 30	10221-30
96 x 172 x 34	10221-34
96 x 172 x 40	10221-40
96 x 172 x 50	10221-50

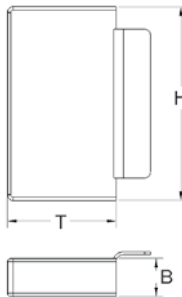

T x H x B /mm	Best.-Nr.
45 x 172 x 30	10210-30
45 x 172 x 34	10210-34
45 x 172 x 40	10210-40
45 x 172 x 50	10210-50

Schliesskasten zum Einbetonieren,  
Gehäuse und Schliessblech  
Gâche à encastrer pour béton,  
Boîtier et platine de gâche  
Striking box to set in concrete,  
Lock case and striking plate  
Scatola di chiusura per serratura per porta scorrevole, ad incastro,  
Serratura e controbocchetta  
Karşılık kasası betonlama çatalları ile  
Kasa ve ayna

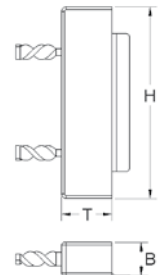

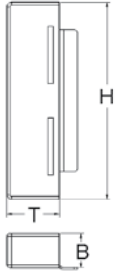

B x H = 96 mm x 172 mm

T x H x B /mm	Best.-Nr. DIN Rechts
45x172x30	10221-30-E
45x172x34	10221-34-E
45x172x40	10221-40-E
45x172x50	10221-50-E

Gegenkasten vorgerichtet für e-Öffner  
Gâche avec fente pour ouverture de porte électrique  
Striking box with slot for electric door opener  
Controbocchetta per serratura elettrica  
Elektrikli kapı otomatığı için karşılık kasası

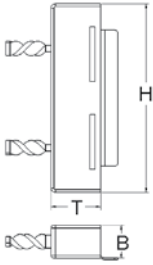

T x H x B /mm	Best.-Nr. DIN Rechts
45x172x30	10210-30-E
45x172x34	10210-34-E
45x172x40	10210-40-E
45x172x50	10210-50-E

Gegenkasten vorgerichtet für e-Öffner  
Gâche avec fente pour ouverture de porte électrique  
Striking box with slot for electric door opener  
Controbocchetta per serratura elettrica  
Elektrikli kapı otomatığı için karşılık kasası



E = 72 mm, A = 60 mm

T x H x B /mm	Best.-Nr.
130 x 250 x 30	10203-30
130 x 250 x 34	10203-34
130 x 250 x 40	10203-40
130 x 250 x 50	10203-50

Design-Schlossgehäuse,  
Links oder rechts verwendbar, 2-tourig  
Boîtier de serrure design ,  
Disponible droite et gauche, à 2 tours.  
Design lock case,  
Left or right side usage with 2-tours lock.  
Serratura design,  
Utilizzabile sia a destra che a sinistra, scrocco  
a doppio giro.  
Dizayn kilit kasası,  
Sağ ve Sol olarak kullanılabilir, iki türlü kilit ile.

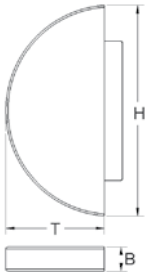

T x H x B /mm	Best.-Nr.
130 x 250 x 30	10223-30
130 x 250 x 34	10223-34
130 x 250 x 40	10223-40
130 x 250 x 50	10223-50

Design-Gegenkasten,  
Links oder rechts verwendbar  
Gâche design ,  
Utilisable droite et gauche  
Design striking case,  
Left or right side usage  
Controbocchetta design,  
Utilizzo a sinistra o a destra  
Dizayn karşılık kasası,  
Sağ ve sol olarak kullanılabilir

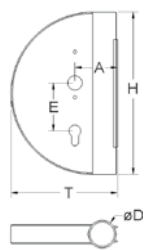

Anschluss "rund"  
Fixation pour barreau  
"Round" connection  
Attacco speciale per incastro su tubi  
Boruya montaj için

øD in mm	T x H /mm	Best.-Nr.
42,4	130 x 250	10202-42
48,3	130 x 250	10202-48

Design-Schlossgehäuse,  
Links oder rechts verwendbar, 2-tourig  
Boîtier de serrure design ,  
Disponible droite et gauche, à 2 tours.  
Design lock case,  
Left or right side usage with 2-tours lock.  
Serratura design,  
Utilizzabile sia a destra che a sinistra, scrocco  
a doppio giro.  
Dizayn kilit kasası,  
Sağ ve Sol olarak kullanılabilir, iki türlü kilit ile.

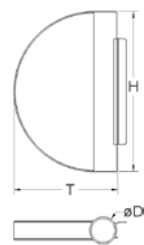

Anschluss "rund"  
Fixation pour barreau  
"Round" connection  
Attacco speciale per incastro su tubi  
Boruya montaj için

øD /mm	T x H /mm	Best.-Nr.
42,4	130 x 250	10222-42
48,3	130 x 250	10222-48

Design-Gegenkasten,  
Links oder rechts verwendbar  
Gâche design ,  
Utilisable droite et gauche  
Design striking case,  
Left or right side usage  
Controbocchetta design,  
Utilizzo a sinistra o a destra  
Dizayn karşılık kasası,  
Sağ ve sol olarak kullanılabilir



**AK FER**

**Schloss & Zubehör / Serrures & Accessoires**  
**Locks & Accessories / Serrature e Accessori / Kilitler & Aksesuarları**



Einsteckschloss – Lose  
Serrure à encastrer  
Mortise Lock  
Serratura a incastro  
Gömme kilit

Für/ for/ pour	Best.-Nr.
10230	10230-L
10230-40	10230-40-L
10200-30	10200-30-L
10200-34	10200-34-L
10200-40	10200-40-L
10200-50	10200-50-L



Einsteckschloss mit Hakenfalle – Lose  
Serrure à encastrer à crochet  
Mortise lock for sliding doors with hook  
Serratura a scrochetto per porta scorrevole  
Sürgülü kapılar için kancalı gömme kilidi

Für/for/pour	Best.-Nr.
10250-30	10250-30-L
10250-34	10250-34-L
10250-40	10250-40-L
10250-50	10250-50-L

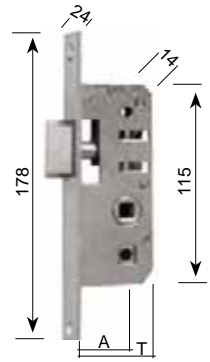

Rohrrahmenschloss, verzinkt.  
Serrure pour profils tubulaires, galvanisée.  
Tubular frame lock, galvanised.  
Serratura, zincata  
Gömme kilit, galvanizli

T /mm	A /mm	Best.-Nr.
30,5	18	10235-18
36,5	24	10235-24
41,5	30	10235-30
46,5	35	10235-35
51,5	40	10235-40

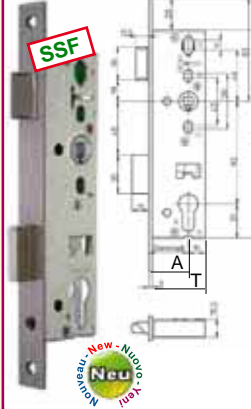

Rohrrahmenschloss, verzinkt. 1-tourig  
Serrure pour profils tubulaires, galvanisée.  
1 tour  
Tubular frame lock, galvanised. 1-tour  
Serratura, zincata. A giro unico  
Gömme kilit, galvanizli. Tek tur

T /mm	A /mm	Best.-Nr.
30,5	18	10233-18
36,5	24	10233-24
41,5	30	10233-30
46,5	35	10233-35
51,5	40	10233-40

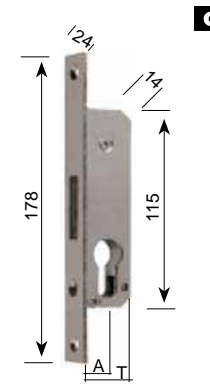

Rohrrahmenschloss, verzinkt. 1-tourig  
Serrure pour profils tubulaires, galvanisée. 1 tour  
Tubular frame lock, galvanised. 1-tour  
Serratura, zincata. A giro unico  
Gömme kilit, galvanizli. Tek tur

T /mm	A /mm	Best.-Nr.
30,5	18	10232-18
36,5	24	10232-24
41,5	30	10232-30
46,5	35	10232-35
51,5	40	10232-40



Elektrischer Türöffner mit Entriegelung,  
Links oder Rechts verwendbar  
Gâche électrique avec levier de déblocage.,  
Utilisable droite et gauche  
Electric door opener with mechanical release.,  
Left or right side usage  
Apertura elettrica con meccanismo a rilascio  
meccanico,  
Utilizzo a sinistra o a destra  
Elektrikli kapı açma otomatığı,  
Sağ ve sol olarak kullanılabilir

6-12V AC/DC,  
67 x 16,5 x 28,5 mm

Best.-Nr. 10270

**AK FER**

**Schliessbleche / Platines de gâche**  
**Striking plates / Controbocchette / Kilit aynaları**

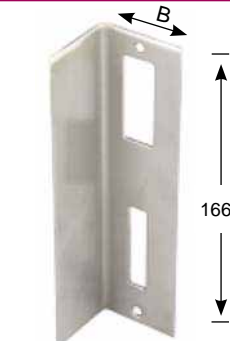

B = 30, 34, 40 mm  
Best.-Nr. 10212-B



B =  $\varnothing$  33,7 / 42,4 / 48,3 mm  
Best.-Nr. 10213-B



B = 24, 28, 34 mm  
Best.-Nr. 10211-B



B = 24, 28, 34 mm  
Best.-Nr. 10211E-B



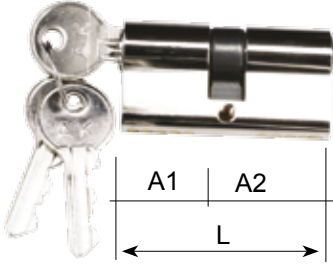

*"ecoline"*

verschiedenschließend / système de clés multiples  
different keying / sistema di chiavi multiple / farklı kilitleme

A1-A2 /mm	L /mm	Best.-Nr.
10-30	40	10240-1030
21-21	42	10240-2121
25-25	50	10240-2525
28-28	56	10240-2828
30-30	60	10240-3030
30-35	65	10240-3035
30-40	70	10240-3040
35-35	70	10240-3535
35-40	75	10240-3540
40-40	80	10240-4040

gleichschließend / serrures avec clés communes  
cylinders with common keys / cilindri con chiavi comuni  
Ortak anahtarlı silindirler

A1-A2 /mm	L /mm	Best.-Nr.
10-30	40	10240-1030-G
21-21	42	10240-2121-G
25-25	50	10240-2525-G
28-28	56	10240-2828-G
30-30	60	10240-3030-G
30-35	65	10240-3035-G
30-40	70	10240-3040-G
35-35	70	10240-3535-G
35-40	75	10240-3540-G
40-40	80	10240-4040-G

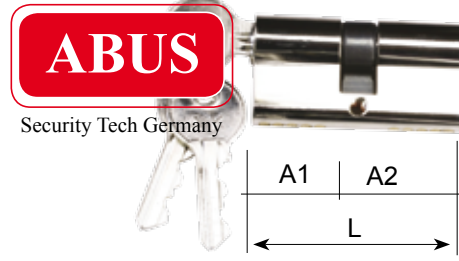

Security Tech Germany

verschiedenschließend / système de clés multiples  
different keying / sistema di chiavi multiple / farklı kilitleme

A1-A2 /mm	L /mm	Best.-Nr.
10-30	40	10241-1030
21-21	42	10241-2121
25-25	50	10241-2525
28-28	56	10241-2828
30-30	60	10241-3030
30-35	65	10241-3035
30-40	70	10241-3040
35-35	70	10241-3535
35-40	75	10241-3540
40-40	80	10241-4040

gleichschließend / serrures avec clés communes  
cylinders with common keys / cilindri con chiavi comuni  
Ortak anahtarlı silindirler

A1-A2 /mm	L /mm	Best.-Nr.
10-30	40	10241-1030-G
21-21	42	10241-2121-G
25-25	50	10241-2525-G
28-28	56	10241-2828-G
30-30	60	10241-3030-G
30-35	65	10241-3035-G
30-40	70	10241-3040-G
35-35	70	10241-3535-G
35-40	75	10241-3540-G
40-40	80	10241-4040-G



A-Wechselstift, min M6-Gewinde  
Rectangle, embout fileté M6  
Spindle, with M6-thread and slotted edge  
Adattatore con filetto M6 ad un'estremità  
Yanklı ve M6 diş uçlu kol pimi

A x L /mm	Best.-Nr.	Paket/Stk./ pcs.
8 x 80	B-8a/8x80	10
8 x 85	B-8a/8x85	10
8 x 95	B-8a/8x95	10
8 x 105	B-8a/8x105	10
8 x 115	B-8a/8x115	10

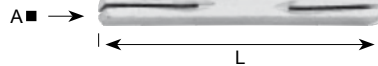

A-Vollstift, beidseitig gekerbt  
Rectangle, fendu aux deux extrémités  
Spindle, slotted at both edges  
Adattatore, con fessure alle estremità  
Uçları yarıklı kol pimi

A x L /mm	Best.-Nr.	Paket/Stk./ pcs.
8 x 80	B-ZH9a/8x80	10
8 x 100	B-ZH9a/8x100	10
8 x 130	B-ZH9a/8x130	10



Reduzierhülse  
Manchon adaptateur  
Spindle adapter  
Adattatore  
Kol pimi adaptörü

Abmessung /mm	Best.-Nr.	Paket/Stk./ pcs.
9 auf/to/en 8	B-ZH25/9-8	10
10 auf/to/en 8	B-ZH25/10-8	10

**AK** ALU

**Aluminium - Beschläge / Poignées en aluminium**  
**Aluminium handles / Maniglie in alluminio / Alüminyum kapı kolları**



Best.-Nr. **B-113**  
L x T = 125 x 53 mm



Best.-Nr. **B-471**  
L x T = 125 x 55 mm



Best.-Nr. **B-171**  
L x T = 125 x 53 mm



Best.-Nr. **B-290**  
L x T = 135 x 55 mm



Best.-Nr. **B-1510**  
L x T = 125 x 53 mm

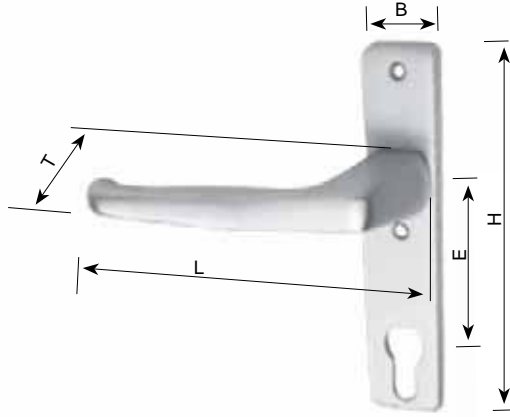

Best.-Nr. **B-290/20-HD**  
L x T = 135 x 55 mm  
B x H = 32 x 204 mm  
E = 92 mm,

Best.-Nr. **B-290/21-D**  
L x T = 135 x 55 mm  
B x H = 32 x 155 mm  
E = 72 mm,

F1 = Farbe / Couleur / Colour / Colori / Renk

8 mm = Stift / Branches quadrangulaires / Profile spindles / Barre di connessione / Montaj Çubuğu

F = Fest / Fix / Fix / Fisso / Sabit

D = Drehbar / Rotative / Non-Fixed / Rotante / Çevrilebilir

LxT = Mass Drücker / Dimension de la poignée / Handle Size / Dimensioni della maniglia / Kol ölçüsü

BxH = Mass Schild / Dimensions de la plaque / Plate Size / Dimensione della placca / Ayna ölçüsü



Best.-Nr. **B-471/20-HD**  
L x T = 135 x 55 mm  
B x H = 32 x 204 mm  
E = 92 mm,

Best.-Nr. **B-471/21-D**  
L x T = 135 x 55 mm  
B x H = 32 x 155 mm  
E = 72 mm,

**AK** ALU

**Aluminium - Beschläge / Poignées en aluminium**  
**Aluminium handles / Maniglie in alluminio / Alüminyum rozetler**



Best.-Nr. **B-239-N**  
Ø 52 mm,



Best.-Nr. **B-237-N**  
Ø 52 mm,



Best.-Nr. **B-238-N**  
Ø 52 mm,



Best.-Nr. **B-221**  
B x H = 27 x 65 mm,



Best.-Nr. **B-233**  
B x H = 27 x 65 mm,



Best.-Nr. **B-232**  
B x H = 27 x 65 mm,



Best.-Nr. **B-222**  
B x H = 27 x 65 mm,



Best.-Nr. **B-223**  
B x H = 27 x 65 mm,



Best.-Nr. **B-20**  
B x H = 31 x 204 mm  
E = 72 mm



Best.-Nr. **B-20 HD**  
E = 92 mm



Best.-Nr. **B-21-D**  
B x H = 32 x 155 mm,  
E = 72 mm

**Bu ürünlerin Türkiye'de satışı yoktur!**

**AK** ALU

**Aluminium - Beschläge / Poignées en aluminium**  
**Aluminium handles / Maniglie in alluminio / Alüminyum kapı kolları**

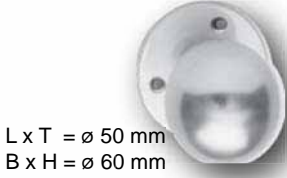

L x T = ø 50 mm  
B x H = ø 60 mm  
Best.-Nr.  
**B-306-F**  
**B-306-D**

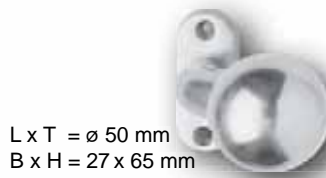

L x T = ø 50 mm  
B x H = 27 x 65 mm  
Best.-Nr.  
**B-271/10-50F**  
**B-271/10-50D**

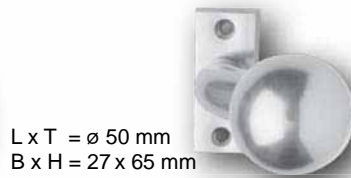

L x T = ø 50 mm  
B x H = 27 x 65 mm  
Best.-Nr.  
**B-271/11-50F**  
**B-271/11-50D**



L x T = ø 50 mm  
B x H = 32 x 155 mm  
E = 72 mm  
Best.-Nr.  
**B-306-21 F**  
**B-306-21 D**



L x T = ø 50 mm  
B x H = 27 x 65 mm  
Best.-Nr.  
**B-306-10 F**  
**B-306-10 D**



L x T = ø 50 mm  
B x H = 27 x 65 mm  
Best.-Nr.  
**B-306-20 HF**  
**B-306-20 HD**

L x T = ø 50 mm  
B x H = 31 x 204 mm  
E = 92 mm  
Best.-Nr.  
**B-306-20 HF**  
**B-306-20 HD**



B x H = 32 x 155 mm  
E = 72 mm  
Best.-Nr.  
**B-273-21 F**  
**B-273-21 D**

B x H = 32 x 155 mm  
E = 72 mm  
Best.-Nr.  
**B-307-21 F**  
**B-307-21 D**



B x H = 31 x 204 mm  
E = 92 mm  
Best.-Nr.  
**B-273-20 HF**  
**B-273-20 HD**

F1 = Farbe / Couleur / Colour / Colori / Renk  
8 mm = Stift / Branches quadrangulaires / Profile spindles / Barre di connessione / Montaj Çubuğu  
F = Fest / Fix / Fix / Fisso / Sabit  
D = Drehbar / Rotative / Non-Fixed / Rotante / Çevrilebilir  
LxT = Mass Drücker / Dimension de la poignée / Handle Size / Dimensioni della maniglia / Kol ölçüsü  
BxH = Mass Schild / Dimensions de la plaque / Plate Size / Dimensione della placca / Ayna ölçüsü

**AK** ALU

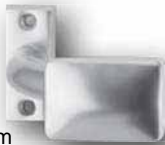

B x H = 27 x 65 mm  
Best.-Nr.  
**B-273/11-50 F**  
**B-273/11-50 D**



B x H = 32 x 85 mm  
Best.-Nr.  
**B-273/225 F**  
**B-273/225 D**

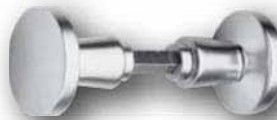

L x T = ø 50 mm  
Best.-Nr.  
**B-307**

L x T = ø 50 mm  
B x H = 32 x 155 mm  
E = 72 mm  
Best.-Nr.  
**B-271-21 F**  
**B-271-21 D**

L x T = ø 50 mm  
B x H = 31 x 204, mm  
E = 92 mm  
Best.-Nr.  
**B-271-20 HF**  
**B-271-21 HD**



L x T = ø 50 mm  
Best.-Nr.  
**B-307 F**  
**B-307 D**



L x T = ø 50 mm,  
B x H = 27 x 65 mm  
Best.-Nr.  
**B-307-10 F**  
**B-307-10 D**



L x T = ø 50 mm  
B x H = 27 x 65 mm  
Best.-Nr.  
**B-307-11 F**  
**B-307-11 D**

**AK** ALU





Handnietzange MULTI 1 / Pince à main pour rivets  
Hand plier rivet tool / Rivettatrice manuale  
Pop perçin makinası

MULTI 1	
Schaft-Ø / Diamètre du corps Shank-Ø / Ø del vástago Gövde çapı	Material / Matériau Material / Materiale / Malzeme
Blindniete / Rivet aveugle Blind rivets / Rivetto a strappo / Kör perçinler	
2,4 - 4,0 mm	alle Materialien / tous matériaux all materials / todos los materiales / tüm malzemeler
4,8 - 5,0 mm	Aluminium / Aluminium Aluminium / Alluminio / Alüminyum
Blindnietmutter / Ecrou pour rivet aveugle Blind rivet nut / Dado per rivetti / Somun perçin	
M4 - M5	Stahl / Steel / Acier / Acciaio / Çelik Aluminium / Aluminium
M6	Aluminium / Alluminio / Alüminyum
Blindnietgewindebolze / Boulon pour rivet aveugle Blind rivet bolt / Bullone per rivetti / Dişli perçin	
M4 - M6	Stahl / Steel / Acier / Acciaio / Çelik

Blindnietgewindebolzen Rifbolt-S Stahl  
Boulon en acier Rifbolt-S pour rivet aveugle  
Blind rivet bolt Rifbolt-S Steel  
Rivetto in acciaio con bullone Rifbolt-S  
Rifbolt-S çelik vida perçin

M	s/mm	l	k	l <sub>max</sub>	øD /mm	d <sub>k</sub>	l <sub>2</sub>	Best.-Nr.
M6	1,5-3,4	12	1,1	7,0	7,8	-	20	20203-S-M6
M8	1,5-3,9	15	1,2	9,0	9,9	-	20	20203-S-M8

Blindnietmutter Universal-E Edelstahl 1.4570/1.4303  
Ecrou en acier universel-S pour rivet aveugle  
Blind rivet nut Universal-E Grade A2 (304)  
Rivetti a strappo universali E in acciaio inox  
Universal-E 304 paslanmaz çelik somun perçin

M	s/mm	l	k	l <sub>max</sub>	øD /mm	Best.-Nr.
M5	0,5-3,0	12,0	0,4	8,5	7,2	20200-E-M5
M6	0,5-3,0	14,0	0,4	10,0	9,6	20200-E-M6
M8	0,5-3,0	14,5	0,4	11,5	10,6	20200-E-M8
gerändelt / cranté / knurled / zigrinatura / tirtilli						
M5	0,5-3,0	18,0	0,5	14,5	7,2	20200-ER-M5
M6	0,7-3,2	20,0	0,5	16,0	9,6	20200-ER-M6
M8	0,7-4,0	23,5	0,5	19,0	10,6	20200-ER-M8
M10	1,0-3,5	26,5	0,7	22,0	12,7	20200-ER-M10



Hebelnietwerkzeug / Pince à bras  
Riveting tool / Rivettatrice a leva  
Somun perçin makinası

VNG 361	
Gewinde / Taraudage Thread / Maschiatura Vida diş	Material / Matériau Material / Materiale / Malzeme
Blindnietmutter / Ecrou pour rivet aveugle Blind rivet nut / Dado per rivetti / Somun perçin	
M4 - M8	alle Materialien / tous matériaux all materials / todos los materiales / tüm malzemeler
M10	Aluminium / Aluminium

**Bu ürünlerin Türkiye'de satışı yoktur!**

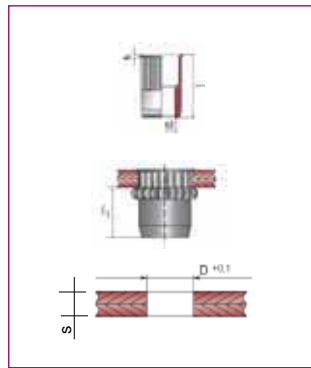
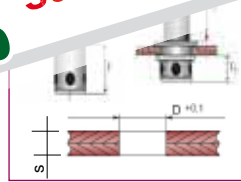

Blindniet-Handzange BZ 2 / Pince à main pour rivets  
Hand plier rivet tool / Rivettatrice manuale  
Pop perçin makinası

BZ 2	
Schaft-Ø / Diamètre du corps Shank-Ø / Ø del vástago Gövde çapı	Material / Matériau Material / Materiale / Malzeme
2,4 mm - 4,0 mm	alle Materialien / tous matériaux all materials / todos los materiales / tüm malzemeler
4,8 - 5,0 mm	Aluminium / Aluminium Aluminium / Alluminio / Alüminyum

Standardausrüstung: komplett mit vier Mundstücken  
Equipment standard BZ 2 complet avec quatre nez  
Standard-equipment: BZ 2 with four nose pieces  
Dotazione standard: BZ 2 completa di quattro becchi  
Standart alet dört adet uç içerir

Blindnietgewindebolzen Rifbolt-E Edelstahl 1.4570/1.4303  
Boulon en Inox 304 Rifbolt-E pour rivet aveugle  
Blind rivet bolt Rifbolt-E Inox 304  
Vite in acciaio inox 304 Rifbolt-E per ribattini ciechi  
Rifbolt-E 304 paslanmaz çelik vida perçin

M	s/mm	l	k	l <sub>max</sub>	øD /mm	d <sub>k</sub>	l <sub>2</sub>	Best.-Nr.
M6	0,5-2,5	11,5	1,0	7,0	7,8	10	15	20202-E-M6
M8	1,0-3,0	14	1,5	9,0	9,9	12	20	20202-E-M8

Blindnietmutter Universal-S Stahl  
Ecrou en acier Universal-S pour rivet aveugle  
Blind rivet nut Universal-S Steel  
Dado in acciaio Universal-S per ribattini ciechi  
Universal-S 304 çelik somun perçin

M	s/mm	l	k	l <sub>max</sub>	øD /mm	Best.-Nr.
M5	0,5-3,0	11,5	0,4	8,0	7	20201-S-M5
M6	0,5-3,0	13,0	0,4	10,0	8	20201-S-M6
M8	0,5-3,0	15,5	0,4	11,5	10	20201-S-M8
M10	0,5-3,0	17,5	0,4	13,0	12	20201-S-M10
gerändelt / cranté / knurled / zigrinatura / tirtilli						
M5	0,5-3,0	11,5	0,4	8,0	7	20201-SR-M5
M6	0,5-3,0	13,0	0,4	10,0	8	20201-SR-M6
M8	0,5-3,0	15,5	0,4	11,5	10	20201-SR-M8
M10	0,5-3,0	17,5	0,4	13,0	12	20201-SR-M10



Blindniete / Rivet aveugle  
Blind rivets / Rivetto a strappo / Kör perçinler

Edelstahl V2A / Inox 304  
Inox 304 / Acciaio inox 304 / Paslanmaz çelik 304

øDxl /mm	Best.-Nr.	VPE/Stk. /pcs
3,0 x 6,0	107080 30060	500
3,0 x 8,0	107080 30080	500
3,0 x 10,0	107080 30100	500
3,0 x 12,0	107080 30120	500
4,0 x 6,0	107080 40060	500
4,0 x 8,0	107080 40080	500
4,0 x 10,0	107080 40100	500
4,0 x 12,0	107080 40120	500
4,0 x 14,0	107080 40140	500
5,0 x 8,0	107080 50080	500
5,0 x 10,0	107080 50100	500
5,0 x 12,0	107080 50120	500
5,0 x 14,0	107080 50140	500
5,0 x 16,0	107080 50160	500

Stahl verzinkt / Acier zingué  
Galvanized steel / Acciaio zincato / Galvanizli çelik

øDxl /mm	Best.-Nr.	VPE/Stk. /pcs
3,0 x 6,0	107070 30060	500
3,0 x 7,0	107070 30070	500
3,0 x 8,0	107070 30080	500
3,0 x 10,0	107070 30100	500
4,0 x 6,0	107070 40060	500
4,0 x 8,0	107070 40080	500
4,0 x 10,0	107070 40100	500
4,0 x 14,0	107070 40140	500
4,0 x 16,0	107070 40160	500
5,0 x 8,0	107070 50080	500
5,0 x 10,0	107070 50100	500
5,0 x 12,0	107070 50120	500
5,0 x 14,0	107070 50140	500
5,0 x 16,0	107070 50160	500

Alu / Stahl verzinkt / Alu / Acier zingué  
Alu / Galvanized steel / Alu / Acciaio zincato  
Alüminyum / Galvanizli çelik

øDxl /mm	Best.-Nr.	VPE/Stk. /pcs
3,0 x 5,0	107000 30050	500
3,0 x 6,0	107000 30060	500
3,0 x 8,0	107000 30080	500
3,0 x 10,0	107000 30100	500
3,0 x 12,0	107000 30120	500
4,0 x 6,0	107000 40060	500
4,0 x 7,0	107000 40070	500
4,0 x 8,0	107000 40080	500
4,0 x 10,0	107000 40100	500
4,0 x 12,0	107000 40120	500
4,0 x 16,0	107000 40160	500
5,0 x 8,0	107000 50080	500
5,0 x 10,0	107000 50100	500
5,0 x 12,0	107000 50120	500
5,0 x 14,0	107000 50140	500
5,0 x 16,0	107000 50160	500
5,0 x 18,0	107000 50180	500

**V2A-Schrauben / Vis inox 304**

**Inox 304 screws / Viti in acciaio inox 304 / Paslanmaz çelik vidalar**

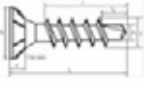

**Senkkopf-Spanplattenschrauben mit Innenvielzahn und Bohrspitze, in A2**

d/mm	L-/mm	Best.-Nr.
4	30-18	S9044-4 x 30
4	35-24	S9044-4 x 35
4	40-24	S9044-4 x 40
4	45-30	S9044-4 x 45
4	50-30	S9044-4 x 50
4,5	40-24	S9044-4,5 x 40
4,5	50-30	S9044-4,5 x 50
4,5	60-40	S9044-4,5 x 60
5	40-24	S9044-5 x 40
5	50-30	S9044-5 x 50
5	70-50	S9044-5 x 70
5	80-60	S9044-5 x 80
6	80-60	S9044-6 x 80
6	100-60	S9044-6 x 100

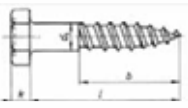

**Sechskant-Holzschrauben nach DIN 571 in A2**

d/mm	l/mm	Best.-Nr.
5	50	S571-5 x 50
5	60	S571-5 x 60
6	50	S571-6 x 50
6	60	S571-6 x 60
6	70	S571-6 x 70
6	80	S571-6 x 80
8	60	S571-8 x 60
8	80	S571-8 x 80
8	100	S571-8 x 100
10	60	S571-10 x 60
10	80	S571-10 x 80
10	100	S571-10 x 100
10	120	S571-10 x 120

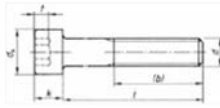

**Zylinderschrauben mit Innensechskant nach DIN 912 in A2**

d/mm	l/mm	Best.-Nr.
M 6	20	S912-6 x 20
M 6	30	S912-6 x 30
M 8	20	S912-8 x 20
M 8	30	S912-8 x 30
M 8	40	S912-8 x 40
M 10	30	S912-10 x 30
M 10	40	S912-10 x 40
M 10	50	S912-10 x 50
M 12	30	S912-12 x 30
M 12	40	S912-12 x 40
M 12	60	S912-12 x 60



**Unterlegscheiben Form A (ohne Fase) nach DIN 125 in A2**

für	d2/mm	Best.-Nr.
M 6	12	S125-6
M 8	16	S125-8
M 10	20	S125-10
M 12	24	S125-12



**Federringe Form B (glatt) nach DIN 127 in A2**

für	d2/mm	Best.-Nr.
M 6	11,8	S127-6
M 8	14,8	S127-8
M 10	18,1	S127-10
M 12	21,4	S127-12



**Sechskant-Hutmutter, nach DIN 1587 in A2**

d/mm	h/mm	Best.-Nr.
M 5	10	S1587-M 5
M 6	12	S1587-M 6
M 8	15	S1587-M 8
M 10	18	S1587-M 10
M 12	22	S1587-M 12



**Senkschrauben mit Innensechskant nach DIN 7991 in A2**

d/mm	l/mm	Best.-Nr.
M 5	10	S7991-5 x 10
M 5	20	S7991-5 x 20
M 6	10	S7991-6 x 10
M 6	16	S7991-6 x 16
M 6	20	S7991-6 x 20
M 6	30	S7991-6 x 30
M 8	16	S7991-8 x 16
M 8	30	S7991-8 x 30
M 8	50	S7991-8 x 50
M 10	30	S7991-10 x 30
M 10	50	S7991-10 x 50
M 10	70	S7991-10 x 70



**Gewindestangen, Länge l=1 m nach DIN 975 in A2**

d/mm	l/mm	Best.-Nr.
M 5	1000	S975-M 5
M 6	1000	S975-M 6
M 8	1000	S975-M 8
M 10	1000	S975-M 10
M 12	1000	S975-M 12

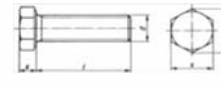

**Sechskantschrauben mit Gewinde < Kopf nach DIN 933 in A2**

d/mm	l/mm	Best.-Nr.
M 6	20	S933-6 x 20
M 6	25	S933-6 x 25
M 6	30	S933-6 x 30
M 8	20	S933-8 x 20
M 8	30	S933-8 x 30
M 8	40	S933-8 x 40
M 10	30	S933-10 x 30
M 10	50	S933-10 x 50
M 12	30	S933-12 x 30
M 12	40	S933-12 x 40
M 12	50	S933-12 x 50
M 12	60	S933-12 x 60



**Stockschrauben mit Holz- und ISO-Gewinde in A2**

d/mm	l/mm	Best.-Nr.
M 6	50	S9082-6 x 50
M 6	60	S9082-6 x 60
M 6	70	S9082-6 x 70
M 8	60	S9082-8 x 60
M 8	80	S9082-8 x 80
M 8	100	S9082-8 x 100
M 10	80	S9082-10 x 80
M 10	100	S9082-10 x 100
M 10	120	S9082-10 x 120
M 12	80	S9082-12 x 80
M 12	100	S9082-12 x 100
M 12	120	S9082-12 x 120

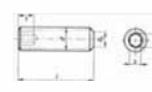

**Gewindestifte mit Innensechskant und Kegelkuppe nach DIN 913 in A2**

d/mm	l/mm	Best.-Nr.
M 5	6	S913-5 x 6
M 5	8	S913-5 x 8
M 5	10	S913-5 x 10
M 6	6	S913-6 x 6
M 6	10	S913-6 x 10
M 6	20	S913-6 x 20
M 8	10	S913-8 x 10
M 8	20	S913-8 x 20



Schaft/mm	Best.-Nr.
6 x 20	12420
6 x 25	12421
6 x 30	12422
6 x 35	12423
6 x 40	12424
6 x 50	12425
8 x 20	12426
8 x 25	12427
8 x 30	12428
8 x 35	12429
8 x 40	12430
8 x 50	12431

**Sicherheitsschrauben "SG-FIX"**



verzinkt / zingué / galvanized / zincato / galvanizli

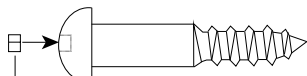

Sechskantbolzen

Abmessung/mm	Best.-Nr.
8 x 50	12400
8 x 70	12401
8 x 90	12402
10 x 80	12403
10 x 100	12404
10 x 130	12405

## AK EQUIP

### Schleifmittel / Abrasifs Abrasives / Abrasivi / Zımparalar

**Lamellenscheiben**  
Disques à lamelles / Flap discs  
Disco lamellare / Flap diskler



Zirkonkorund / Corindon-zircon  
Corindon zircon / Corindon-zircon / Korindon zircon Ø 115 mm,  
10 Stk./pcs. in Box

Körnung /mm	Best.-Nr.
40	12075
60	12076
80	12077

Zirkonkorund / Corindon-zircon  
Corindon zircon / Corindon-zircon / Korindon zircon Ø 125 mm,  
10 Stk./pcs. in Box

Körnung /mm	Best.-Nr.
40	12070
60	12071
80	12072

**Trennscheiben**  
Disques à tronçonner / Cutting discs  
Dischi da taglio / Kesici diskler



Metall,  
25 Stk./pcs. in Box

Abmessung /mm	Best.-Nr.
115 x 1,0 x 22	12012-T
125 x 1,0 x 22	12022-T

**Professional Quality !**

**Trennscheiben**  
Disques à tronçonner / Cutting discs  
Dischi da taglio / Kesici diskler

**Bu ürünlerin Türkiye'de satışı yoktur!**



25 Stk./pcs. in Box

Abmessung /mm	Best.-Nr.
115 x 2,5 x 22	12011
125 x 2,5 x 22	12021
180 x 3,0 x 22	12042
230 x 3,0 x 22	12051

**Fiberscheiben**  
Disques à fibres / Fiber discs  
Dischi in fibra / Fiber diskler

Normalkorund / Corindon classique  
Normal Corindon / Corindone classico  
Normal korindon  
25 Stk./pcs. in Box

Abmessung /mm	Körnung /mm	Best.-Nr.
115 x 22	40	12060
115 x 22	60	12061
115 x 22	80	12062
115 x 22	100	12063
115 x 22	120	12064
125 x 22	40	12080
125 x 22	60	12081
125 x 22	80	12082
125 x 22	100	12083
125 x 22	120	12084
180 x 22	40	12090
180 x 22	60	12091
180 x 22	80	12092
180 x 22	100	12093
180 x 22	120	12094

**Schruppscheiben**  
Disques d'affutage / Grinding discs  
Dischi da taglio / Taşlama diskleri

Mit DSA Zulassung  
Certification DSA  
With DSA approval  
Con approvazione DSA  
DSA onaylı  
10 Stk./pcs. in Box



Abmessung /mm	Best.-Nr.
115 x 6,5 x 22	12016
125 x 6,5 x 22	12026
180 x 6,0 x 22	12046
230 x 6,0 x 22	12056



**Hilfs- und Befestigungsmittel / Autres articles de montage**  
**Additives & Fasteners / Additivi e prodotti per il fissaggio**  
**Yardımcı malzemeler**

**Akbaş**

*Korkuluk & Metal Ürünleri*

**MIT-SVPolyester-Mörtel, styrolfrei**  
 Eigenschaften  
 • Europäische Technische Zulassung  
 Option 7 für ungerissenen Beton  
 • Bauaufsichtlich zugelassen für Mauerwerk  
 • Brandschutzprüfung F30-F120  
 • Keine Geruchsbelästigung da styrolfrei  
 • Mörtelfarbe grau  
**Anwendungen**  
 Stahlkonstruktionen, Holzkonstruktionen, Fassaden, Fassadengerüste, Geländer, Hochregale

**MIT-SV Mortier polyester, sans styrene**  
 Caractères  
 • Agrément technique européen option 7 pour béton non fissuré  
 • Résistance au feu jusqu'à F120  
 • Sans styrene - pas de gêne due à une odeur  
 • Couleur de mortier: gris  
**Applications**  
 constructions métalliques, constructions en bois, façades, échafaudages, garde-corps, rayonnages hauts

**MIT-SV Polyester mortar, styrene free**  
**Features**  
 • European Technical Approval Option 7 for uncracked concrete  
 • Fire resistance classification F30-F120  
 • Low odour  
 • Colour of mortar: grey  
**Applications**  
 steel constructions, wooden constructions, facades, facade scaffolds, railings, high-racks

**Collante MIT-SV Polyester, senza styrene**  
 • Approvazione Tecnica Europea  
 Opzione 7 per malta non crepata  
 • Certificazione ufficiale per muratura  
 • Classificazione ignifuga F30-F120  
 • Color grigio chiaro  
**Applicazioni**  
 Costruzioni in acciaio, legno, facciate, impalcature, cancellate, recinzioni

**MIT-SP Polyester harçlı, stirensiz**  
 • Çatlak olmayan beton için Avrupa Teknik Onayı Opsiyon 7  
 • Yığma duvar için Almanya yapı denetim onayı  
 • Yangına dayanıklı F30-F120  
 • Kokusuz  
 • Harç rengi: gri  
**Uygulamalar**  
 Çelik yapılar, Ağaç yapılar, Cepheleer, Cephe iskeleleri, Korkuluklar, Yüksek raflar



**MIT-SV 350 ml**  
 Best.-Nr.  
**1710038**  
 12 Stk./pcs. Karton



**Kartusche incl. 2 Mischer / Cartouche avec deux mélangeurs**  
**Cartridge incl. 2 mixers / Il ricambio include 2 mixer / Kartuş, iki mikserli**

	6÷10° C	11÷15° C	16÷20° C	21÷25° C	26÷30° C	31÷35° C
<b>Verarbeitung / Traitement</b>						
<b>Working / Funzionamento / Çalışan</b>	25 Min.	15 Min.	6 Min.	4 Min.	3 Min.	2 Min.
<b>Aushärtung / Prise</b>						
<b>Hardening / Irrigidimento / Sertleşme</b>	120 Min.	80 Min.	50 Min.	35 Min.	30 Min.	25 Min.

**Auspresspistole MIT**  
**Pistolet à cartouches MIT / Injection gun MIT**  
**Pistola a iniezione MIT / Kartuş tabancası MIT**



Best.-Nr. **1710033**

**Universal-Siebhülse**  
**Manchon universel / Universal sleeve**  
**Manica universale / MSH Universal - Elek**

für/ pour/ for/ per M10 , M12  
 M10, M12 için

Best.-Nr.  
**S-SHK 15x85**  
 ø 15 x 85 mm

Best.-Nr.  
**S-SHK 15x130**  
 ø 15x130 mm



**K-A-L-M VMK SF 280**  
**Polyester-Verbundmörtel**

Styrolfrei mit Zulassung Option 12 für ungerissenen Beton  
**345 ml Kartusche inkl. 2 Statikmischer**



**KALM Polyester mortier, sans styrene**  
**Features**  
 • Can be used on concrete  
 • Low odour  
**Applications**  
 steel constructions

**Bu ürünlerin Türkiye'de satışı yoktur!**

**K-A-L-M VMK SF 345**  
**Polyester-Verbundmörtel**  
 Styrolfrei mit Zulassung Option 12 für ungerissenen Beton  
**345 ml Kartusche inkl. 2 Statikmischer**



**Kartusche incl. 2 Mischer / Cartouche avec deux mélangeurs**  
**Cartridge incl. 2 mixers / Il ricambio include 2 mixer**

	-5° C	0° C	5° C	20° C	30° C	40° C
<b>Verarbeitung / Traitement / Working / Funzionamento / Çalışan</b>	45 Min.	25 Min.	12Min.	4 Min.	3 Min.	2 Min.
<b>Aushärtung / Prise / Hardening / Irrigidimento / Sertleşme</b>	360 Min.	180 Min.	90 Min.	45 Min.	25 Min.	15 Min.

made in Germany

made in Germany

**E-mail: bilgi@yapimetal.net, www.yapimetal.net**

**Telefon: (312) 385 48 06 - Belgegeçer: (312) 385 42 16**

AK-EQUIP

## m2 Stahlbolzen / Goujon en acier / Through bolt anchors / Bullone in acciaio / m2 Ağır yük dübelleri

- Europäisch Technische Zulassung Option 7 für ungerissenen Beton
- Galvanisch verzinkt > 5 µm
- Standard européen option 7 pour béton non fissuré
- Galvanisé > 5 µm
- European Technical Approval Option 7 for uncracked concrete
- Zinc plated > 5 µm
- Approvazione Tecnica Europea Opzione 7 per malta non crepata
- Zincato > 5 µm
- Avrupa Teknik Onayı Opsiyon 7, çatlak olmayan beton için
- Galvaniz kaplama > 5 µm



- 1- Dübel & Bohr ø/mm / Forage et cheville ø/mm  
Plug & drill ø/mm / Diametro foro ø/mm / Dübel & delik ø/mm
- 2- Dübellänge mm / Longueur mm / Length mm / Lunghezza mm / Uzunluk mm
- 3- Bohrtiefe mm / Profondeur mm  
Drilling depth mm / Profondità di perforazione mm / Delme derinliği
- 4- Nutzlänge mm / Profondeur d'ancrage minimum  
Setting depth min. mm / Profondità minima di fissaggio mm / Etkili uzunluk mm
- 5- Verpackt zu Stück / Pièces par lot / Box contents / Contenuto di ogni scatola / Kutu miktarı
- 6- Sammelkarton Stk. / Grand lot / Outer carton / Confezione scatole / Diş karton

Best.-Nr.	1	2	3	4	5	6
3200885	8	85	50	15	100	300
3201009	10	95	58	15	100	300
3201011	10	110	58	30	50	150
3201211	12	110	68	15	50	150
3201212	12	125	68	30	50	150

## m2r Stahlbolzen rostfrei A4 / Goujon inox A4

### Throughbolt, stainless steel A4 / Bullone, acciaio inox A4 / Paslanmaz çelik dübel, 316 kalite

- Europäisch Technische Zulassung Option 7 für ungerissenen Beton
- Nichtrostender Stahl A4/316
- Standard européen option 7 pour béton non fissuré
- Inox A4/316
- European Technical Approval Option 7 for uncracked concrete
- Stainless steel A4/316
- Approvazione Tecnica Europea Opzione 7 per malta non crepata
- Acciaio inox A4/316
- Avrupa Teknik Onayı Opsiyon 7, çatlak olmayan beton için
- Paslanmaz çelik 316



3300808	8	80	50	10	100	300
3300809	8	95	50	25	100	300
3300885	8	85	50	15	100	300
3301009	10	95	58	15	100	300
3301011	10	110	58	30	50	150
3301211	12	110	68	15	50	150
3301212	12	125	68	30	50	150

## MQ Quattro Nylondübel / Chevilles en nylon

### Nylon plug / Tassello in nylon / Plastik dübel



- Aus hochwertigem Polyamid PA 6 gefertigt
- Réalisé en polyamide 6 de haute qualité
- Made from high-quality polyamide PA 6
- Prodotto d'alta qualità in polyamide PA6
- Yüksek kaliteli PA6 polyamid malzeme

Schraubentyp Holz/Span  
Type de vis bois  
Screw type wood/chipboard  
Per vite da legno/truciolato di misura  
Ağaç vidası

Schraubentyp metrisch  
Screw type metric  
Type de vis métrique  
Tipologia codice  
Matkap delik ölçüsü

1050050	5	25	2,6 - 4	M3	100
1050060	6	30	3,5 - 5	M4	100
1050080	8	40	4,5 - 6	M5	100
1050100	10	50	6 - 8	M6	50
1050120	12	60	8 - 10	M8	25
1050140	14	70	10 - 12	M10	20

## HSS Metallbohrer / Tête de perceuse HSS

### HSS Drill bit / Punta trapano HSS

### HSS adaptörlü Matkap ucu



Best.-Nr.	ø /mm	L /mm
2070402	4,0	75
2070452	4,5	80
2070502	5,0	85
2070552	5,5	90
2070602	6,0	95
2070652	6,5	100
2070702	7,0	105
2070802	8,0	110
2070852	8,5	115
2071002	10,0	130
2071052	10,5	133
2071202	12,0	151
2071252	12,5	151
2071602	16,0	178

## SDS -Hammerbohrer / Tête de perceuse SDS

### SDS Drill bit / Punta trapano SDS

### SDS adaptörlü darbeli Matkap ucu



Mit SDS-Plus Aufnahme



Best.-Nr.	ø /mm	L /mm
2018101	6	110
2018102	6	160
2018103	8	110
2018104	8	160
2018105	10	110
2018106	10	160
2018107	10	210
2018121	12	160
2018122	12	210
2018161	16	160
2018162	16	210
2018163	16	260

**Bu ürünlerin Türkiye'de satışı yoktur!**

**Hilfs- und Befestigungsmittel / Autres articles de montage**  
**Additives & Fasteners / Additivi e prodotti per il fissaggio**  
**Yardımcı malzemeler**

**Akbaş**

*Korkuluk & Metal Ürünleri*

Verkauf nur in geschlossenen Packungen / Vendu uniquement sous emballage  
 Only sold with closed package / Viene venduto esclusivamente in confezione multipla / Sadece kapalı paket ile satılır.

**Stahlbolzen / Goujon en acier / Through bolt anchors / Bullone in acciaio / Ağır yük dübelleri**

**KAK-E**

- Europäisch Technische Zulassung Option 1 für gerissenen und ungerissenen Beton
- Nichtrostender Stahl A4/316
- Standard européen option1 pour béton fissuré et non fissuré
- Inox A4/316
- European Technical Approval Option 1 for cracked and uncracked concrete
- Stainless steel A4/316
- Approvazione Tecnica Europea Opzione 1 per malta crepata e non crepata
- Acciaio inox A4/316
- Avrupa Teknik Onayı Opsiyon 1, çatlak ve çatlak olmayan beton için
- Paslanmaz çelik 316



A4 / Inox 316



- 1- Dübel & Bohr ø/mm / Forage et cheville ø/mm / Plug & drill ø/mm / Diametro foro ø/mm / Dübel & delik ø/mm
- 2- Dübellänge mm / Longueur mm / Length mm / Lunghezza mm / Uzunluk mm
- 3- Bohrtiefe mm / Profondeur mm
- Drilling depth mm / Profondità di perforazione mm / Delme derinliği
- 4- Nutzlänge mm / Profondeur d'ancrage minimum
- Setting depth min. mm / Profondità minima di fissaggio mm / Etkil uzunluk mm
- 5- Verpackt zu Stück / Pièces par lot / Box contents / Contenuto di ogni scatola / Kutu miktarı
- 6- Sammelkarton Stk. / Grand lot / Outer carton / Confezione scatole / Dış karton

Best.-Nr.

	1	2	3	4	5	6
S-KAK-E 10-10/92	10	92	75	10	40	200
S-KAK-E 10-30/112	10	112	75	30	25	125
S-KAK-E 12-20/118	12	118	90	20	20	100

**Stahlbolzen / Goujon en acier / Through bolt anchors / Bullone in acciaio / Ağır yük dübelleri**

**KAK**

- Europäisch Technische Zulassung Option 1 für gerissenen und ungerissenen Beton
- Galvanisch verzinkt
- Standard européen option1 pour béton fissuré et non fissuré
- Galvanisé > 5 µm
- European Technical Approval Option 1 for cracked and uncracked concrete
- Zinc plated > 5 µm
- Approvazione Tecnica Europea Opzione 1 per malta crepata e non crepata
- Zincato > 5 µm
- Avrupa Teknik Onayı Opsiyon 1, çatlak ve çatlak olmayan beton için
- Galvaniz kaplama > 5 µm



Best.-Nr.

	1	2	3	4	5	6
S-KAK 10-10/92	10	92	75	10	40	200
S-KAK 10-30/112	10	112	75	30	25	125
S-KAK 12-20/118	12	118	90	20	20	100

**Stahlbolzen / Goujon en acier / Through bolt anchors / Bullone in acciaio / Ağır yük dübelleri**

**KDK-E**

- Europäisch Technische Zulassung Option 7 für ungerissenen Beton
- Nichtrostender Stahl A4/316
- Standard européen option 7 pour béton non fissuré
- Inox A4/316
- European Technical Approval Option 7 for uncracked concrete
- Stainless steel A4/316
- Approvazione Tecnica Europea Opzione 7 per malta non crepata
- Acciaio inox A4/316
- Avrupa Teknik Onayı Opsiyon 7, çatlak olmayan beton için
- Paslanmaz çelik 316



A4 / Inox 316



Best.-Nr.

	1	2	3	4	5	6
S-KDK-E 8-15/80	8	80	65	15	50	400
S-KDK-E 10-10/80	10	80	70	10	50	250

**Stahlbolzen / Goujon en acier / Through bolt anchors / Bullone in acciaio / Ağır yük dübelleri**

**KDK**

- Europäisch Technische Zulassung Option 7 für ungerissenen Beton
- Galvanisch verzinkt > 5 µm
- Standard européen option 7 pour béton non fissuré
- Galvanisé > 5 µm
- European Technical Approval Option 7 for uncracked concrete
- Zinc plated > 5 µm
- Approvazione Tecnica Europea Opzione 7 per malta non crepata
- Zincato > 5 µm
- Avrupa Teknik Onayı Opsiyon 7, çatlak olmayan beton için
- Galvaniz kaplama > 5 µm



Best.-Nr.

	1	2	3	4	5	6
S-KDK 8-15/80	8	80	65	15	50	400
S-KDK 10-10/80	10	80	70	10	50	250

E-mail: bilgi@yapimetal.net, www.yapimetal.net

Telefon: (312) 385 48 06 - Belgegeçer: (312) 385 42 16

AK-EQUIP



AK EQUIP



400 ml.  
Best.-Nr.  
25100

**Edelstahl-Pflegespray / Spray d'entretien pour inox**  
**Stainless steel maintenance spray / Spray per acciaio INOX**  
**Paslanmaz çelik yüzey bakım spreyi**

Zur Reinigung, Pflege und Schutz von matten und polierten Edelstahlflächen im Innen- und Außenbereich. Wirkt antistatisch.

Anwendungsgebiete:

1. entfernt und verhindert Fingerabdrücke
2. reinigt streifenfrei auch grössere Flächen
3. lässt behandelte Flächen wie neu wirken
4. hinterlässt einen langanhaltenden Schutzfilm, der Wasser abperlen lässt
5. verhindert das erneute Anhaften von Schmutz

Used to clean and for maintenance of stainless steel surfaces indoor and outdoor. Antistatic effect.

Applications:

1. removes and prevents finger prints
2. cleans larger areas
3. cleaned areas to be as new
4. leaves a protective film on surface for a long period
5. prevents dirt from re-adhering

Pour nettoyer et entretenir les surfaces en inox en intérieur et extérieur. Effet antistatique.

Utilisations:

1. efface et protège des traces de doigts
2. nettoie de grandes surfaces
3. surfaces lavées comme neuves
4. dépose un film protecteur sur la surface pour une longue durée
5. empêche l'adhésion de la saleté

Per pulire e lucidare superfici in acciaio, sia interne che esterne. Effetto antistatico.

Applicazioni:

1. rimuove e previene le impronte digitali
2. Pulisce superfici estese.
3. Superfici pulite, come nuove
4. lascia una pellicola protettiva sulla superficie per un lungo periodo
5. impedisce allo sporco di ri-aderire

Uygulamalar:

1. parmak izini temizler ve önler
2. büyük alanların dahi temizlenmesini sağlar
3. işlenmiş yüzeyleri yeni gibi yapar
4. uzun süre dayanıklı koruyucu tabaka bırakır
5. kirin tekrar yapışmasını önler

İç ve dış ortamlarda kullanılan paslanmaz çelik yüzeylerin temizlik ve bakımında kullanılır. Antistatiktir.

made  
in  
Germany

**WS Zink-Farbe 108**

- Metallisch glänzend, Silbereffekt
- guter Witterungsschutz

**WS Couleur Zinc 108**

- Aspect métal, effet argent
- résistant aux intempéries

**WS Zinc Paint 108**

- Metal-looking, silver effect
- Weatherproof

**WS Colore Zinco 108**

- Assomigliante al metallo, effetto argento
- Resistente alle alte temperature

**WS Soğuk Galvaniz Boyası 108**

- Metal görünümlü, gümüş efekti
- Hava şartlarına dayanıklı



250 ml.  
Best.-Nr. 25080  
500 ml.  
Best.-Nr. 25081

**WS-Zink Spray 108**

**WS-Spray zinc 108**

**WS-Zinc Spray 108**

**WS-Spray Zinco 108**

**WS-Soğuk Galvaniz Spreyi 108**



400 ml.  
Best.-Nr. 25070

**WS-Patina**

Witterungsbeständig für außen und innen. Extrem ergiebig.

**Patine WS.**

Résistant aux intempéries, forte efficacité.

**WS-Patina**

Weather proof and extremely productive.

**Patina WS.**

Impermeabile e estremamente produttiva.

**WS Patina**

Eskitme Boyaları. Dış ortamlara dayanıklı ve verimli.

Farben / Couleurs / Colours / Colori / Renkler	Best.-Nr.
grün / vert / green / verde / yeşil	25034
violett / violet / violet / viola / viyole	25035
gold / or / gold / oro / altın	25031
kupfer / cuivre / copper / rame / bakır	25032
silber / argent / silver / argento / gümüş	25033



AK EQUIP

WS-Plast Dickschicht M 4200 / Enduit épais WS-Plast M 4200  
WS-Plast Thick film epoxy paint M 4200 / Vernice epossidica WS-Plast M 4200  
WS-Plast Kalın film epoksi boya M 4200

Langfristiger dekorativer Schutz. Direkthaftende Flüssig-  
kunststoff- Farbe wie z.B. auf Aluminium, Kupfer, Messing,  
Edelstahl, frischer Feuerverzinkung, hart PVC u.v.m.

Protection décorative longue durée. Adhésion directe  
de la peinture. Pour aluminium, cuivre, laiton, inox, PVC  
épais.

Decorative protection for long period. Direct adhesive  
epoxy paint. Painted on Aluminium, Copper, Brass,  
Stainless steel, Galvanized, hard PVC

Protezione decorativa di lungo periodo. Aderisce diret-  
tamente. Per alluminio, ottone, acciaio, superfici galvaniz-  
zate e PVC rigido.

Uzun süreli dekoratif koruma. Doğrudan yapışan epoksi  
boya. Alüminyum, Bakır, Pirinç, Paslanmaz çelik, Galva-  
niz, sert plastik üzerinde uygulanır.

Top



2,5 l

Best.-Nr. 25002

11 kg

Best.-Nr. 25004

Sondertöne

Sondertöne, die von den Standardfarbtönen abweichen,  
können nach RAL-Karte bzw. Mustervorlage getönt werden.  
Lieferumfang min. 2,5 l.

Farben / Couleurs / Colours / Colori / Renkler

RAL 1013	perlweiß	RAL 8001	ockerbraun
RAL 1021	rapsgelb	RAL 8014	sepiabraun
RAL 2000	gelborange	RAL 8017	schokoladenbraun
RAL 3000	feuerrot	RAL 9002	grauweiß
RAL 3003	rubinrot	RAL 9007	graualuminium
RAL 5010	enzianblau	RAL 9010	reinweiß
RAL 6005	moosgrün	RAL 9016	verkehrsweiß
RAL 6009	tannengrün	0001	schmiedeschwarz
RAL 6010	grasgrün	0002	eloxalbraun
RAL 6011	resedagrün	0003	graphit EG
RAL 7001	silbergrau	RAL 0004	silber
RAL 7016	anthrazit	0005	kupfer
RAL 7023	betongrau	0006	farblos
RAL 7030	steingrau	0007	altkupfer
RAL 7035	lichtgrau	0008	schwarzglimmer

made  
in  
Germany



WS-Verdünnung MV 751

Zum Verdünnen von WS-Plast  
Dickschicht, WS-Plast-Haft-  
grund und WS-Patinierfarbe

Diluant WS

Diluant pour

WS-Thinner

Thinner for WS

Diluyente WS

Diluyente per prod

WS-Tiner MV 751

WS-Plast boya, astar ve  
patinasına uygun tiner

Inhalt /Liter	Best.-Nr.
1,0	25040
5,0	25042
10,0	25050

AK EQUIP



WS-Korrogrund

Hochwertige Zinkphosphat-  
Grundierung, schnelltrock-  
nend, ergiebig.  
Farbtöne: grau, rotbraun

Peinture anti-rouille WS

Haute qualité, séchage rapide,  
forte efficacité.  
Couleur: gris, bordeaux

WS-Primer paint

High quality zinc phosphate  
primer, quick-drying, productive.  
Color: Gray, maroon

Colore WS Primer

Fosfato di zinco di alta qualità,  
asciuga rapidamente.  
Colore: grigio, marrone

WS-Astar boya

Yüksek kalite çinko fosfat astar,  
hızlı kuruma ve verimliliğe sa-  
hiptir. Renkler: Gri ve kestane

Best.-Nr. 25091

2,5 Liter-Dose

Best.-Nr. 25090

12,5 kg Eimer

AK EQUIP

Bu ürünlerin  
Türkiye'de  
satışı yoktur!

## SAROX Edelstahl-Beizpaste L1 / Pâte décapante L1 Pickling paste L1 / Detergente per superfici in acciaio L1 Asitli temizleme pastası - L1

Speziell entwickelt für glänzende und geschliffene Edelstahloberflächen in IIIc/IIIId-Qualität.  
Produit développé spécifiquement pour surfaces en inox brillantes de qualité IIIc/IIIId.  
Developed specifically for shiny and IIIc/IIIId quality polished stainless steel surfaces.  
Sviluppato specificatamente per superfici lucide e di qualità IIIc / IIIId in acciaio inox.  
Parlak ve IIIc/IIIId kalitesinde satine polisajlanmış paslanmaz çelik yüzeyler için geliştirilmiştir.



2 kg, Best.-Nr. 25061

Extrem geruchs- und schadstoffreduziert. Entfernt Anlauffarben, Verzunderungen, Oxide im Schweißnahtbereich und in waermebehandelten Zonen.



## Extra Edelstahl-Beizpaste Extra / Pâte décapante Extra Pickling paste Extra / Detergente per superfici in acciaio Extra SAROX Asitli temizleme pastası - Extra

Entfernt Anlauffarben, Verzunderungen, Oxide im Schweißnahtbereich und in waermebehandelten Zonen.

2 kg, Best.-Nr. 25060



**Bu ürünlerin Türkiye'de satışı yoktur!**

## AKBAS-C Edelstahl-Beizpaste / Pâte décapante de acier inoxydable Pickling paste / Detergente per superfici in acciaio inox più pulito Asitli temizleme ilacı

umweltfreundlich !

Entfernt Flugrost und Oxide  
Vols au depart de la rouille et les oxydes  
Remote from flight rust and oxides  
Voli da ruggine e di ossidi  
Pas ve oksitlenmeleri yok eder

1000 ml, Best.-Nr. 25062

**Bu ürünün Türkiye'de satışı yoktur!**



## WEICON Klebstoffe / Adhésifs / Adhesives / Adesivo / Yapıştırıcılar



### COSMOPLAST 500L

ein schnellhärtender 1-Komponenten-Klebstoff für die handwerkliche und industrielle Anwendung  
cyan-acrylic adhesive

Best.-Nr. 25116  
20 ml,



WEICON  
Dosierpistole  
Best.-Nr./Code 25115

### WEICONLOCK

1-Komponenten, anaerob aushärtender Kleb- und Dichtstoff speziell für Metallverbindungen.

WEICONLOCK products are high quality anaerobic adhesives and sealants on the basis of special methacrylate resins, especially made for economical threadlocking, retaining and sealing of threaded, cylindrical and pipe

Best.-Nr. 25110  
20 ml,



### Epoxyd-Minutenkleber

2-Komponenten, transparente und restelastisch aushärtende, Klebstoffe, welche die meisten Materialien, wie: Metall, Glas, Stein, Keramik, Holz und viele Kunststoffe mit- und untereinander verbinden.

WEICON Epoxy Minute Adhesive  
This transparent adhesive retains elasticity after curing and is ideal for jobs in construction and assembly and in fact in all cases where the use of WEICON Easy-Mix Systems would not be efficient. viscid, self-levelling very short pot life (3 - 4 minutes) fast-curing almost colourless, glass clear.

Best.-Nr. 25113  
24 ml,



Info : [www.weicon.de](http://www.weicon.de)



Metallbau Mebra GmbH, D - 03149 Forst



Metallbau Mebra GmbH, D - 03149 Forst



Metallbau Mebra GmbH, D - 03149 Forst



Metallbau Mebra GmbH, D - 03149 Forst



Metallbau Mebra GmbH, D - 03149 Forst



Bauschlosserei Höchst GmbH & Co. KG, D - 35510 Butzbach





