

B x H x s /mm	Best.-Nr.	Paket/Stk/paquet
100 x 50 x 6	10980	135
120 x 60 x 6	10981	100
120 x 60 x 8	10982	75
120 x 80 x 6	10983	80
120 x 80 x 8	10984	60
100 x 100 x 6	10985	65
100 x 100 x 8	10986	50
120 x 120 x 6	10987	44
120 x 120 x 8	10988	36
150 x 100 x 8	10989-150	32
200 x 125 x 8	10989-200	20

øD x s /mm	Best.-Nr.	Paket/Stk/pcs
27 x 3	10948	100
30 x 4	10947	100
33 x 4	10930	100
42 x 4	10931	100
48 x 4	10932	100
60 x 4	10933	100
70 x 4	10934	100
70 x 6	10935	100
80 x 4	10936	100
80 x 6	10937	100

øD x s /mm	Best.-Nr.	Paket/Stk/paquet
80 x 8	10938	100
100 x 4	10939	100
100 x 6	10940	80
100 x 8	10941	60
120 x 4	10942	80
120 x 6	10943	55
120 x 8	10944	45
150 x 6	10945	35
150 x 8	10946	27

øD x s /mm	Best.-Nr.	Paket/Stk/paquet
80 x 6	10912	100
80 x 8	10913	100
100 x 6	10914	85
100 x 8	10915	65
120 x 6	10916	60
120 x 8	10917	50

øD x s /mm	Best.-Nr.	Paket/Stk/paquet
100 x 100 x 8	10986-OB	50
120 x 80 x 8	10984-OB	60
120 x 120 x 8	10988-OB	36
150 x 100 x 8	10989-150-OB	32
200 x 125 x 8	10989-200-OB	20

øD x s /mm	Best.-Nr.	Paket/Stk/paquet
70 x 6	10920	100
80 x 6	10921	100
80 x 8	10922	100
100 x 6	10923	85
100 x 8	10924	65
120 x 6	10925	60
120 x 8	10926	45
150 x 6	10927	35
150 x 8	10928	28

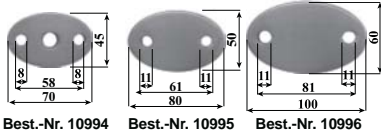

B x H x s /mm	Best.-Nr.
70 x 45 x 6	10994
80 x 50 x 6	10995
100 x 60 x 6	10996

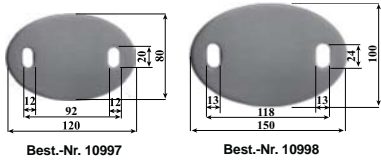

B x H x s /mm	Best.-Nr.
120 x 80 x 6	10997
150 x 100 x 6	10998

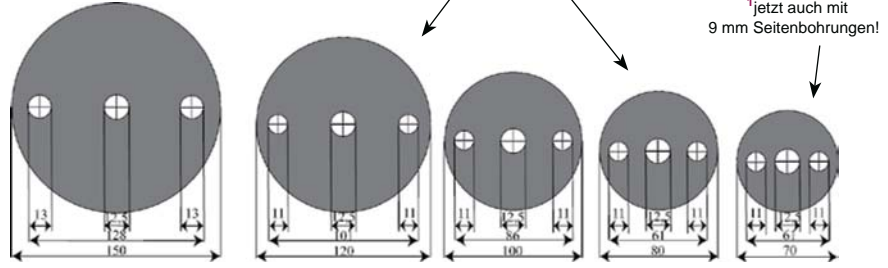
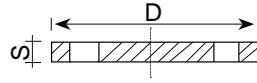

¹ Seitenbohrungen / Troux latéraux

Edge holes / Adesso con foro / Kenar delikleri : 9 mm

² Seitenbohrungen / Troux latéraux

Edge holes / Adesso con foro / Kenar delikleri : 13 mm

øD x s /mm	Best.-Nr.	Paket/Stk /paquet
70 x 6	10909 ¹	100
70 x 6	10900	100
80 x 6	10901	100
80 x 8	10903	100
100 x 6	10902	85
100 x 8	10904	65

øD x s /mm	Best.-Nr.	Paket/Stk /paquet
100 x 8	10910 ²	65
120 x 6	10905	60
120 x 8	10906	45
120 x 8	10911 ²	45
150 x 6	10907	35
150 x 8	10908	28

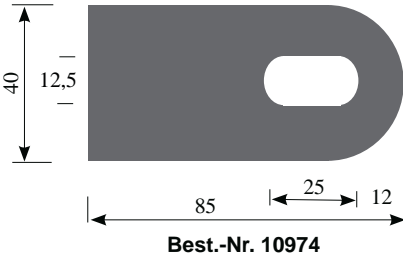

Best.-Nr. 10974

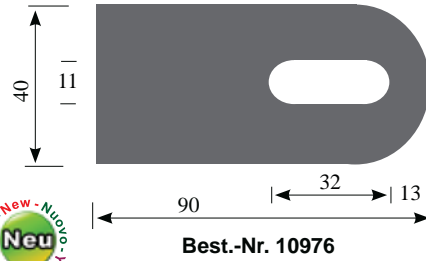

Best.-Nr. 10976

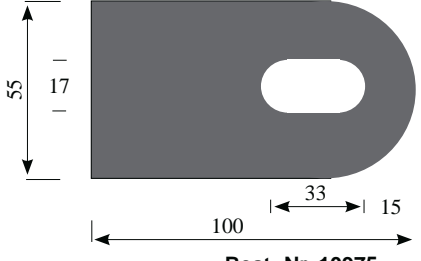

Best.-Nr. 10975

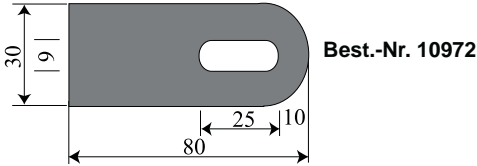

Best.-Nr. 10972

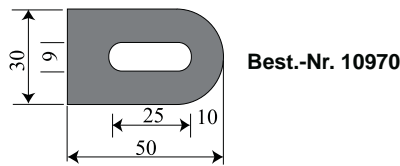

Best.-Nr. 10970

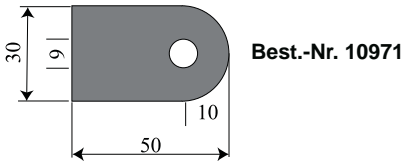

Best.-Nr. 10971

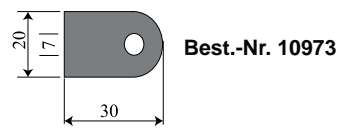

Best.-Nr. 10973

B x H x s /mm	Best.-Nr.
30 x 20 x 4	10973
50 x 30 x 6	10970
50 x 30 x 6	10971
80 x 30 x 6	10972
85 x 40 x 8	10974
90 x 40 x 8	10976
100 x 55 x 8	10975

Wandbefestigung / Articles de fixation

Side mounted bases / Supporti da parete / Duvar montaj elemanları

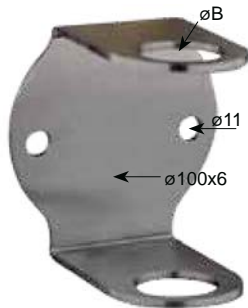

øB /mm	s /mm	Best.-Nr.
33,7	6	10890-33
42,4	6	10890-42
48,3	6	10890-48



A /mm	B /mm	s /mm	Best.-Nr.
30	30	6	10891-30
40	40	6	10891-40

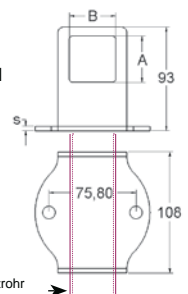
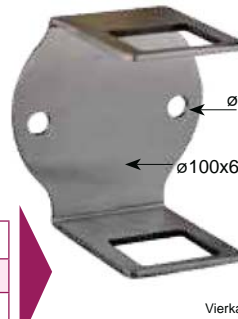

Vierkantrohr
Rectangle tube



Material 2,5 mm
Rohrabschlussstopfen, gewölbt
Embout de fermeture, Bombé / End cap, Cambered
Coperchio, Bombato / Boru kapağı, Bombeli

øD x s /mm	Best.-Nr.
26,9 x 2,0	12806
33,7 x 2,0	12800
33,7 x 2,6	12801
42,4 x 2,0	12802
42,4 x 2,6	12803
48,3 x 2,0	12804
48,3 x 2,6	12805
60,3 x 2,0	12807



Material 2,5 mm
Rohrabschlussstopfen, flach
Embout de fermeture, Plat / End cap, Flat
Coperchio, Piatto / Boru kapağı, Düz

øD x s /mm	Best.-Nr.
26,9 x 2,0	12826
33,7 x 2,0	12820
33,7 x 2,6	12821
42,4 x 2,0	12822
42,4 x 2,6	12823
48,3 x 2,0	12824
48,3 x 2,6	12825
60,3 x 2,0	12827



Material 4 mm
Rohr-Kugelstopfen
Embout hémisphérique / Hemisphere end cap
Coperchio semisferico / Yarım küre boru kapağı

øD x s /mm	Best.-Nr.
33,7 x 2,0	12840
33,7 x 2,6	12841
42,4 x 2,0	12842
42,4 x 2,6	12843
48,3 x 2,0	12844
48,3 x 2,6	12845



Rohrabschlussstopfen, gewölbt mit M8 Gewinde
Embout de fermeture, Bombé avec filetage M8
End cap, Cambered with M8-thread
Coperchio, Coperchio bombato con foro filettato M8
Boru kapağı, Bombeli M8 Dişli

øD x s /mm	Best.-Nr.
26,9 x 2,0	12816-G
33,7 x 2,0	12810-G
33,7 x 2,6	12811-G
42,4 x 2,0	12812-G
42,4 x 2,6	12813-G
48,3 x 2,0	12814-G
48,3 x 2,6	12815-G
60,3 x 2,0	12817-G



Rohrabschlussstopfen, flach mit M8 Gewinde
Embout de fermeture, Plat, filetage M8
End cap, Flat, with M8-thread
Coperchio, Piatto, con foro filettato M8
Boru kapağı, Düz M8 Dişli

øD x s /mm	Best.-Nr.
26,9 x 2,0	12836-G
33,7 x 2,0	12830-G
33,7 x 2,6	12831-G
42,4 x 2,0	12832-G
42,4 x 2,6	12833-G
48,3 x 2,0	12834-G
48,3 x 2,6	12835-G
60,3 x 2,0	12837-G

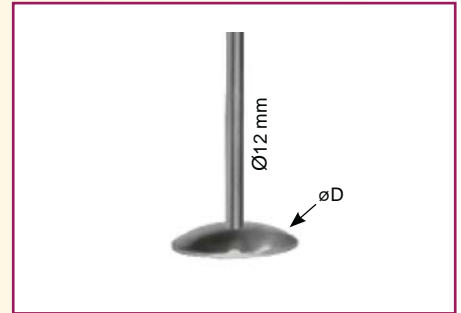

Handlaufstütze / Support cavalier de main-courante
Floor mounted base
Supporto per tubo da pavimento / Montaj ayağı

øD x s /mm	Best.-Nr.
33,7	12990
42,4	12991
48,3	12992
60,3	12993

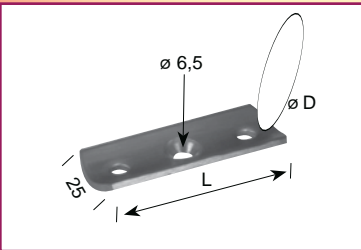

øD /mm	L /mm	Best.-Nr.
33,7	65	12980
42,4	65	12981
48,3	65	12982
33,7	80	12983
42,4	80	12984
48,3	80	12985



Handlaufträger mit 2-Loch
Supports de main-courante avec deux trous
Handrail brackets with two holes
Supporti per corrimano con due fori
Kolçak, 2 delikli

øD x s /mm	øB /mm	Best.-Nr.
70 x 6 mm	9	10990
80 x 6 mm	9	10992
70 x 6 mm	11	10991
80 x 6 mm	11	10993

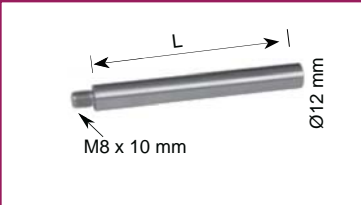

L /mm	Best.-Nr.
65	12995
100	12996

Abdeckrosetten / Rosaces
Cover plates / Copriflange / Rozetler

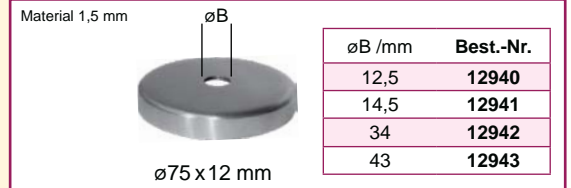

øB /mm	Best.-Nr.
12,5	12940
14,5	12941
34	12942
43	12943



øB /mm	Best.-Nr.
12,5	12936
14,5	12937
34	12938
43	12939



øB /mm	Best.-Nr.
34	12945
43	12946
49	12947



Material 2 mm

Hohlkugeln
Sphères / Spheres / Sfere / Küre

øD /mm	Best.-Nr.
30	12508
40	12501
50	12502
60	12503
70	12505
80	12504
90	12506
100	12507
120	12509
150	12510
200	12511



Vollkugeln
Sphère pleine / Solid ball / Sfere / Dolu Küre

øD /mm	Best.-Nr.
15	12540
20	12541
25	12542
30	12543
35	12544
40	12546
50	12547



Vollkugel mit Durchgangsbohrung 12,5 mm
Sphère pleine troué taille - à calibre 12,5 mm

Solid ball with 12,5 mm hole

Sfera solida con foro 12,5 mm

Dolu küre - 12,5 mm çap delikli

øD /mm	Best.-Nr.
25	12545-25
30	12545-30
35	12545-35

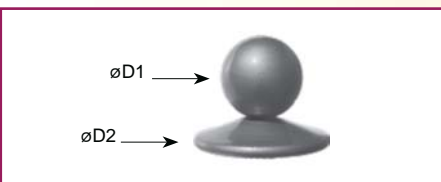

Rohr-Knopf
Pommeaux / Knobs / Pomoli / Topuz

øD2 /mm	øD1 /mm	Best.-Nr.
42	30	12950
48	40	12951
60	50	12952

Material 2 mm

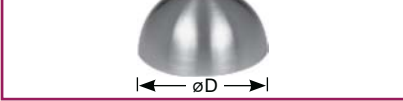

Halbhohlkugeln / Demi-sphère
Hemisphere / Semisfera / Yarım küre

øD /mm	Best.-Nr.
26,9	12516
30	12520
33,7	12517
40	12521
42,4	12518
48,3	12519
50	12522
60	12523
70	12525
80	12524
90	12526
100	12527
120	12528
150	12529
200	12530



Schweissbogen / Coude
Elbow / Raccordo a gomito / Patent Dirsek

øD x s /mm	Best.-Nr.
26,9 x 2,0	12997-26
33,7 x 2,6	12997-33
42,4 x 2,6	12997-42
48,3 x 2,6	12997-48
60,3 x 2,6	12997-60

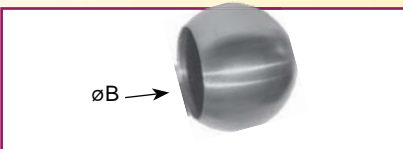

Rohr-Abschlusskugeln / Embout sphérique
Sphere end cap / Coperchio a sfera
Küre boru kapağı

øB /mm	Zoll	øD /mm	Best.-Nr.
26,9	¾"	40	12550
33,7	1"	45	12551
42,4	1¼"	55	12552
48,3	1½"	60	12553

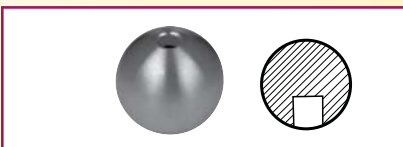

Vollkugeln mit Sackloch
Embout sphérique / Spheres, with blind hole
Sfera, con foro cieco / Dolu küre, kör delikli

øD /mm	Best.-Nr.
25	12548-25
30	12548-30

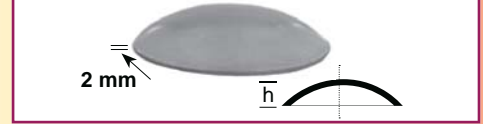

Schale gewölbt / Fermeture bombé
Domed cap / Coperchio bombato / Bombeli kapak

øD /mm	h /mm	Rohr-Tube /Zoll	Best.-Nr.
21	6	½"	10953
26,9	7	¾"	10954
33	8	1"	10960
42	9	1¼"	10961
48	10	1½"	10962
52	10	1¾"	10955
60	11	2"	10963
70	11	2¼"	10964
76	11	2½"	10956
89	12	3"	10957
100	12	3½"	10965
113	13	4"	10958
120	13	4½"	10959

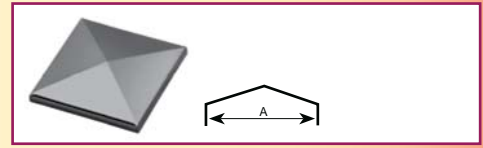

Abdeckkappen
Embouts pyramidaux / Angular caps
Coperchi quadrati ad angolo / Dört köşe kapak

A /mm	Best.-Nr.
20 x 20	12900
20 x 30	12901
20 x 40	12902
30 x 30	12903
30 x 50	12905
40 x 40	12906
40 x 60	12907
50 x 50	12908
60 x 60	12909
80 x 80	12910
100 x 100	12911
120 x 120	12912
150 x 150	12913



Runde Abdeckkappen / Fermeture ronde
Round cap / Coperchio rotondo
Yuvarlak kaynak kapak

øD /mm	Best.-Nr.
33	12920
42	12921
48	12922
60	12923
101	12924

AK FER

Schnörkel / Volutes
Scrolls / Arrotolata / Motifler



Best.-Nr. 6000
80 x 50 mm, 0,13 kg



Best.-Nr. 6036
60 x 120 mm, 0,15 kg



Best.-Nr. 6078
95 x 135 mm, 0,22 kg



Best.-Nr. 6001
100 x 65 mm, 0,15 kg



Best.-Nr. 6005
80 x 170 mm, 0,23 kg



Best.-Nr. 6006
140 x 190 mm, 0,33 kg



Best.-Nr. 6002
120 x 70 mm, 0,17 kg



Best.-Nr. 6085
110 x 240 mm, 0,33 kg



Best.-Nr. 6007
100 x 150 mm, 0,22 kg



Best.-Nr. 6031
140 x 80 mm, 0,20 kg



Best.-Nr. 6072
120 x 260 mm, 0,44 kg



Best.-Nr. 6010
100 x 50 mm, 0,14 kg



Best.-Nr. 6003
160 x 90 mm, 0,23 kg



Best.-Nr. 6009
130 x 330 mm, 0,41 kg



Best.-Nr. 6037
60 x 220 mm, 0,19 kg



Best.-Nr. 6032
180 x 100 mm, 0,25 kg



Best.-Nr. 6008
75 x 210 mm, 0,23 kg



Best.-Nr. 6004
220 x 120 mm, 0,34 kg



Best.-Nr. 6071
140 x 330 mm, 0,58 kg



Best.-Nr. 6038
60 x 220 mm, 0,21 kg



Best.-Nr. 6035
60 x 120 mm, 0,12 kg



Best.-Nr. 6012
80 x 160 mm, 0,16 kg



Best.-Nr. 6033
260 x 70 mm, 0,29 kg



Best.-Nr. 6011
80 x 80 mm, 0,12 kg



Best.-Nr. 6230
120 x 80 mm, 0,20 kg



Best.-Nr. 6034
270 x 75 mm, 0,29 kg

AK FER

Schnörkel - kantengehämmert / Volutes martelées
Scrolls - hammered edges / Motivo - Bordi martellati / Motifler-Köşe dövme



Best.-Nr. 6100
80 x 50 mm, 0,13 kg

Best.-Nr. 6136
60 x 120 mm, 0,15 kg

Best.-Nr. 6178
95 x 135 mm, 0,21 kg



Best.-Nr. 6101
100 x 60 mm, 0,15 kg

Best.-Nr. 6105
80 x 170 mm, 0,22 kg

Best.-Nr. 6106
140 x 190 mm, 0,32 kg



Best.-Nr. 6102
120 x 70 mm, 0,16 kg

Best.-Nr. 6172
120 x 260 mm, 0,42 kg

Best.-Nr. 6107
100 x 150 mm, 0,21 kg



Best.-Nr. 6131
140 x 80 mm, 0,19 kg

Best.-Nr. 6185
110 x 240 mm, 0,32 kg

Best.-Nr. 6135
60 x 120 mm, 0,12 kg



Best.-Nr. 6103
160 x 90 mm, 0,22 kg

Best.-Nr. 6109
130 x 330 mm, 0,39 kg

Best.-Nr. 6137
60 x 220 mm, 0,18 kg



Best.-Nr. 6132
180 x 100 mm, 0,24 kg

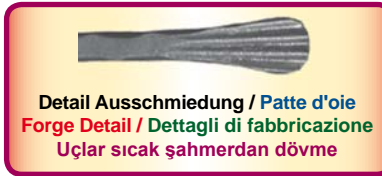

Best.-Nr. 6108
75 x 210 mm, 0,22 kg



Best.-Nr. 6104
220 x 120 mm, 0,33 kg

Best.-Nr. 6171
140 x 330 mm, 0,55 kg

Best.-Nr. 6138
60 x 220 mm, 0,20 kg



Best.-Nr. 6130
120 x 80 mm, 0,18 kg

Best.-Nr. 6111
80 x 80 mm, 0,12 kg

Best.-Nr. 6134
270 x 75 mm, 0,28 kg



Best.-Nr. 6110
100 x 50 mm, 0,14 kg

Best.-Nr. 6112
80 x 160 mm, 0,16 kg



Best.-Nr. 6133
260 x 70 mm, 0,28 kg

AK FER

Leichtbarock-Schnörkel / Volutes - Baroque Léger
Light Baroque scrolls / Motivo Barocco Leggero / Hafif Barok motifler



Best.-Nr. 6201
120 x 80 mm, 0,20 kg



Best.-Nr. 6224



Best.-Nr. 6225

80 x 80 mm
0,12 kg



Best.-Nr. 6202
140 x 90 mm, 0,22 kg



Best.-Nr. 6226



Best.-Nr. 6227

80 x 160 mm
0,17 kg



Best.-Nr. 6203
160 x 90 mm, 0,24 kg



Best.-Nr. 6220



Best.-Nr. 6221

85 x 125 mm
0,15 kg



Best.-Nr. 6205
220 x 130 mm, 0,33 kg



Best.-Nr. 6222



Best.-Nr. 6223

105 x 150 mm
0,15 kg



Best.-Nr. 6260
300 x 220 mm
0,62 kg



Best.-Nr. 6238



Best.-Nr. 6239

140 x 190 mm
0,34 kg



70 x 190 mm
0,22 kg

Best.-Nr. 6246

Best.-Nr. 6247

AK FER



Best.-Nr. 6240



Best.-Nr. 6241

80 x 170 mm
0,23 kg



55 x 260 mm
0,20 kg

Best.-Nr. 6231

Best.-Nr. 6232



Best.-Nr. 6244



Best.-Nr. 6245

140 x 330 mm
0,41 kg



105 x 180 mm
0,26 kg

Best.-Nr. 6236

Best.-Nr. 6237



Best.-Nr. 6261
440 x 350 mm, 0,91 kg



Best.-Nr. 6254

200 x 320 mm, 0,50 kg



Best.-Nr. 6255

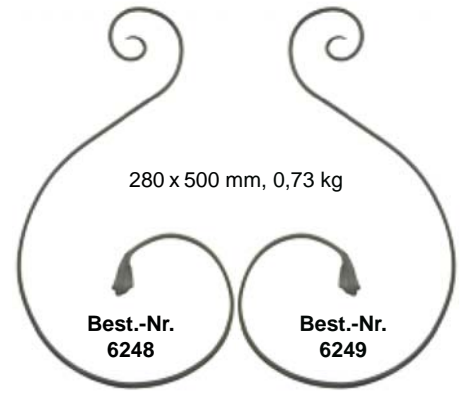

280 x 500 mm, 0,73 kg

Best.-Nr. 6248

Best.-Nr. 6249

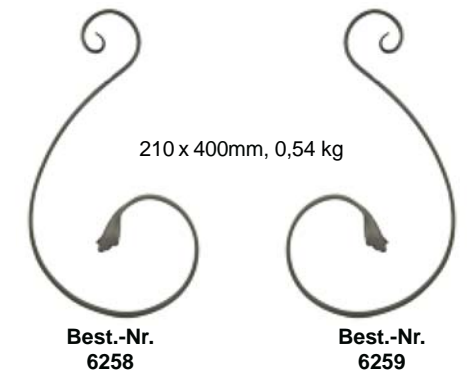

210 x 400mm, 0,54 kg

Best.-Nr. 6258

Best.-Nr. 6259

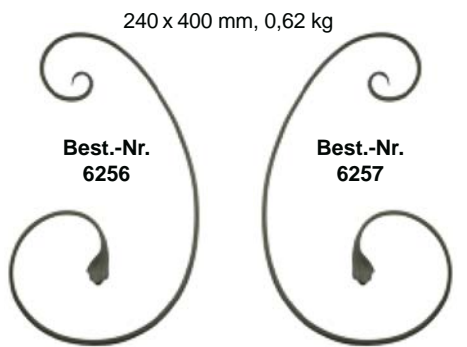

240 x 400 mm, 0,62 kg

Best.-Nr. 6256

Best.-Nr. 6257

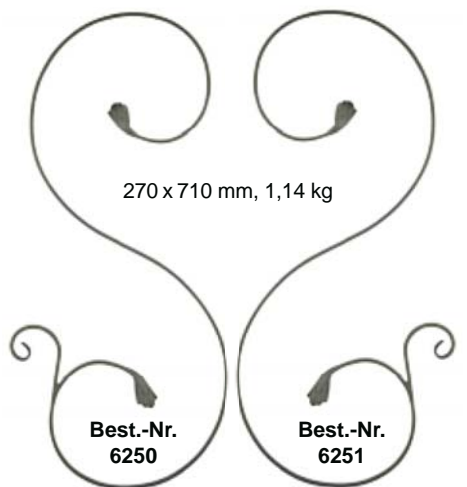

270 x 710 mm, 1,14 kg

Best.-Nr. 6250

Best.-Nr. 6251

Landbarock-Schnörkel / Volutes - Baroque de Pays Country Baroque Scrolls / Motivo Barocco Rustico / Kırsal Barok motifler

Best.-Nr.
14323

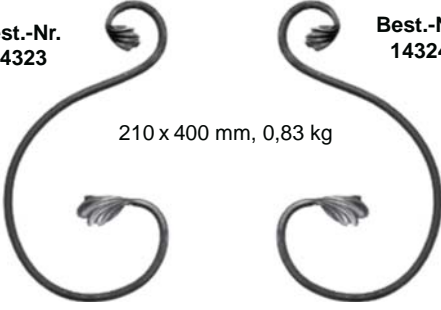

210 x 400 mm, 0,83 kg

Best.-Nr.
14324



Best.-Nr. 14300
120 x 70 mm, 0,27 kg



Best.-Nr.
14313

200 x 320 mm, 0,77 kg



Best.-Nr.
14314

AK FER

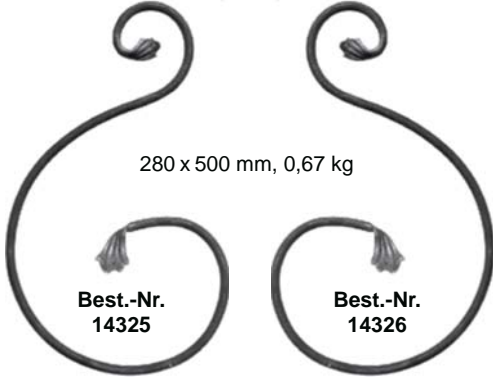

280 x 500 mm, 0,67 kg

Best.-Nr.
14325

Best.-Nr.
14326

Best.-Nr. 14302
160 x 90 mm, 0,32 kg



Best.-Nr.
14315

240 x 400 mm, 0,97 kg



Best.-Nr.
14316



Best.-Nr. 14329
300 x 220 mm, 0,96 kg



Best.-Nr. 14304
220 x 130 mm, 0,50 kg



Best.-Nr. 14334
350 x 90 mm, 0,50 kg



Best.-Nr. 14330
440 x 350 mm, 1,55 kg



AK FER

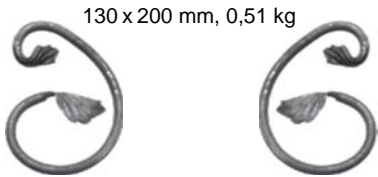

130 x 200 mm, 0,51 kg

Best.-Nr.
14311

Best.-Nr.
14312

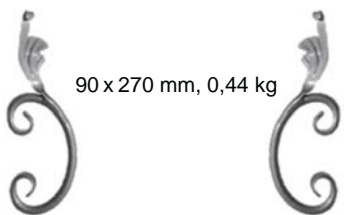

90 x 270 mm, 0,44 kg

Best.-Nr.
14333

Best.-Nr.
14332

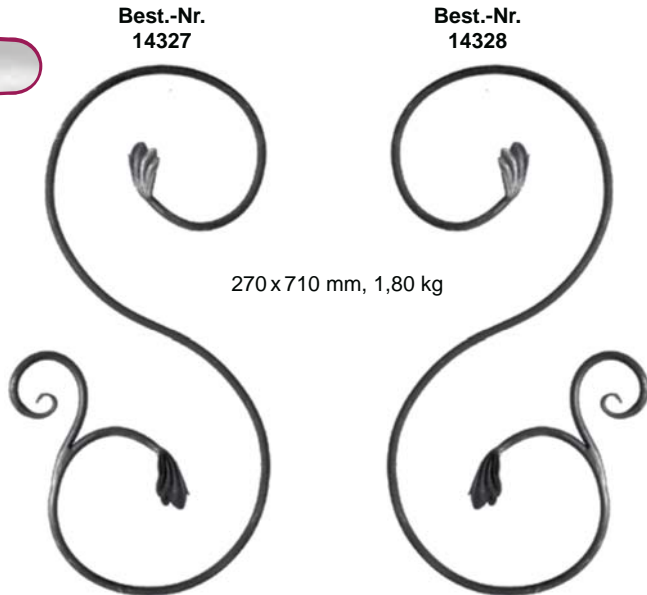

Best.-Nr.
14327

Best.-Nr.
14328

270 x 710 mm, 1,80 kg

AK FER

Meisterbarock-Schnörkel / Volutes - Baroque de Maître
Master Baroque Scrolls / Motivo Artigianale Barocco / Uzman Barok motifler



Best.-Nr. 14129
300 x 220 mm, 1,30 kg

130 x 200 mm, 0,57 kg



Best.-Nr.
14111

Best.-Nr.
14112

AK FER

210 x 400 mm, 0,88 kg



Best.-Nr.
14123

Best.-Nr.
14124



Best.-Nr. 14130
440 x 350 mm, 1,61 kg

200 x 320 mm, 0,84 kg



Best.-Nr.
14113



Best.-Nr.
14114

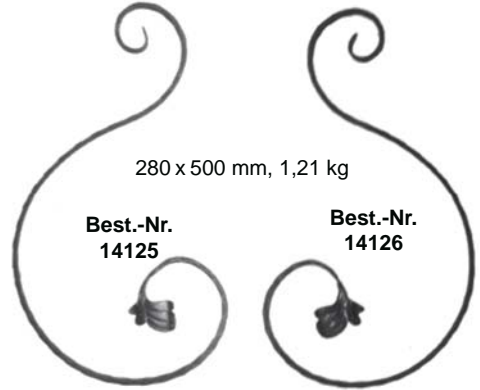

280 x 500 mm, 1,21 kg

Best.-Nr.
14125

Best.-Nr.
14126



Best.-Nr. 14131
550 x 370 mm, 1,77 kg

240 x 400 mm, 1,07 kg



Best.-Nr.
14115

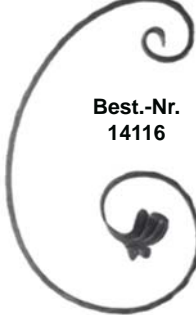

Best.-Nr.
14116

140 x 420 mm, 0,80 kg



Best.-Nr.
14121

Best.-Nr.
14122



Best.-Nr. 14100
120 x 70 mm, 0,26 kg



Best.-Nr. 14102
160 x 90 mm, 0,39 kg



Best.-Nr. 14104
220 x 130 mm, 0,55 kg



Best.-Nr.
14110
130 x 200 mm, 0,54 kg



Best.-Nr.
14107
140 x 330 mm, 0,81 kg

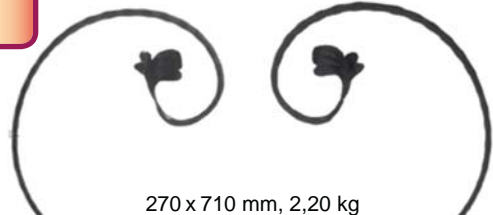

270 x 710 mm, 2,20 kg

Best.-Nr.
14127

Best.-Nr.
14128

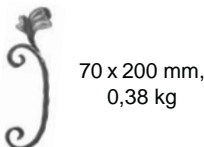

Best.-Nr.
14132

70 x 200 mm,
0,38 kg



Best.-Nr.
14133

Best.-Nr. 14108
100 x 160 mm, 0,40 kg

AK FER

Schwerbarock-Schnörkel / Volutes - Baroque Lourde
Heavy Baroque Scrolls / Motivo Barocco Rigido / Ağır Barok Motifler

130 x 200 mm, 0,50 kg



Best.-Nr.
14212



Best.-Nr.
14211



Best.-Nr. 14200
120 x 70 mm, 0,26 kg



Best.-Nr. 14207
140 x 330 mm, 0,89 kg



Best.-Nr. 14229
300 x 220 mm, 1,20 kg



Best.-Nr. 14202
160 x 90 mm, 0,37 kg

200 x 320 mm, 0,84 kg



Best.-Nr.
14213



Best.-Nr.
14214



Best.-Nr. 14204
220 x 130 mm, 0,55 kg



Best.-Nr. 14210
130 x 200 mm, 0,57 kg



Best.-Nr. 14230
440 x 350 mm, 1,60 kg

240 x 400 mm, 1,01 kg



Best.-Nr.
14215



Best.-Nr.
14216



Best.-Nr. 14208
100 x 160 mm, 0,37 kg

AK FER

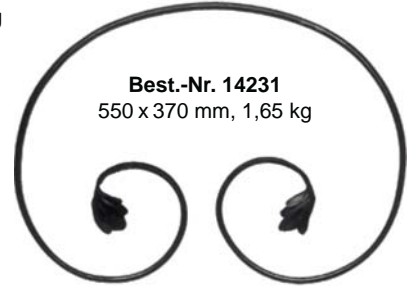

Best.-Nr. 14231
550 x 370 mm, 1,65 kg

140 x 330 mm, 1,20 kg



Best.-Nr.
14234



Best.-Nr.
14235



Detail Ausschmiedung / Patte d'oie
Forge Detail / Dettagli di fabbricazione
Uçlar sıcak şahmerdan dövme

Best.-Nr.
14223

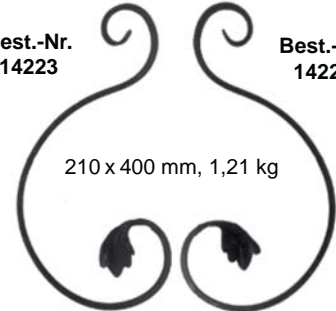

Best.-Nr.
14224

210 x 400 mm, 1,21 kg

140 x 420 mm, 0,80 kg



Best.-Nr.
14221



Best.-Nr.
14222

270 x 710 mm, 2,20 kg

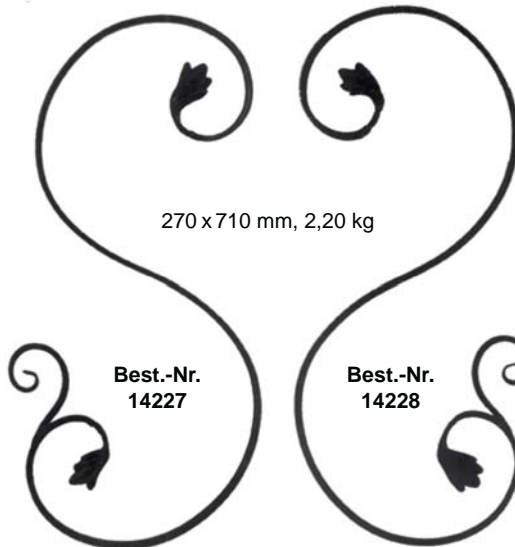

Best.-Nr.
14227

Best.-Nr.
14225



Best.-Nr.
14226

280 x 500 mm, 1,14 kg

AK FER

Designstäbe / Barreaux design
Design bars / Barre decorative / Dizayn çubuklar

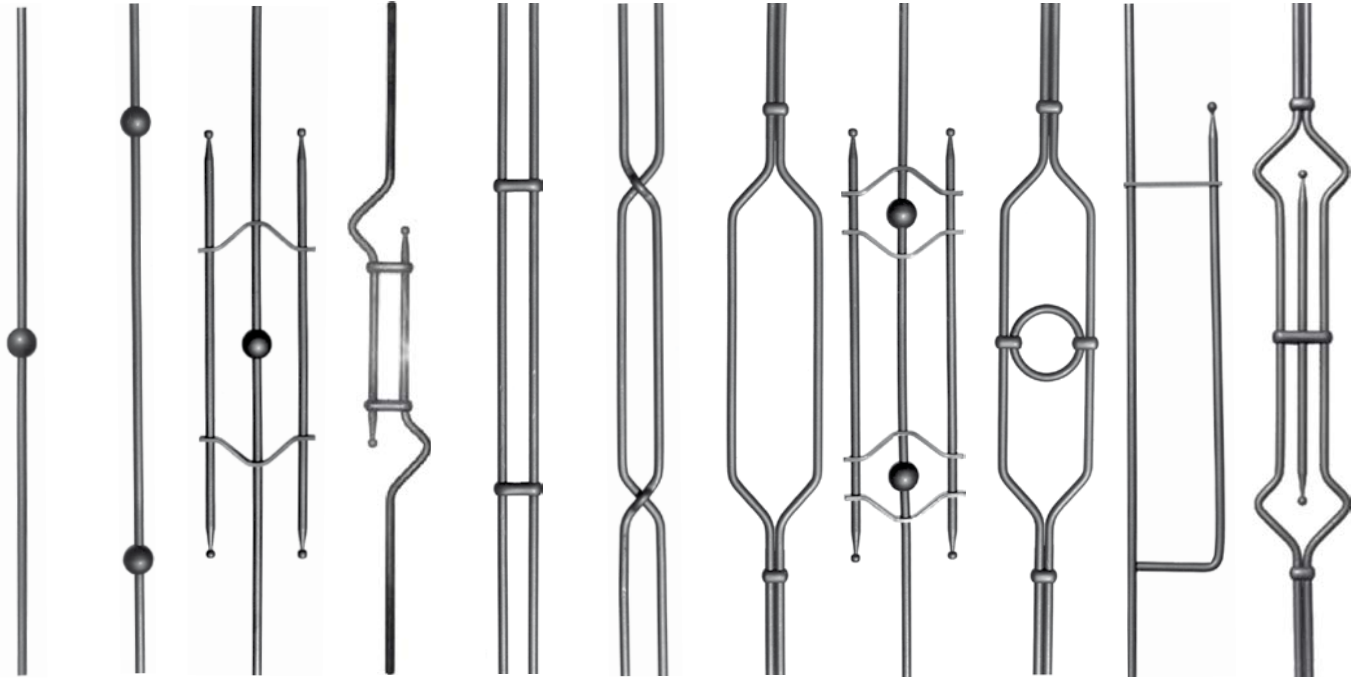

Best.-Nr.	Best.-Nr.	Best.-Nr.	Best.-Nr.	Best.-Nr.	Best.-Nr.	Best.-Nr.	Best.-Nr.	Best.-Nr.	Best.-Nr.	Best.-Nr.
5500	5501	5512	5521	5502	5503	5506	5513	5507	5505	5508
40 x 40 mm	40 x 600 mm	150 x 550 mm	110 x 430 mm	55 x 900 mm	60 x 900 mm	125 x 460 mm	150 x 550 mm	125 x 460 mm	120 x 600 mm	130 x 540 mm
0,91 kg	0,97kg	2,18 kg	1,40 kg	1,87 kg	1,84 kg	1,77 kg	2,45 kg	2,17 kg	1,59 kg	2,34 kg

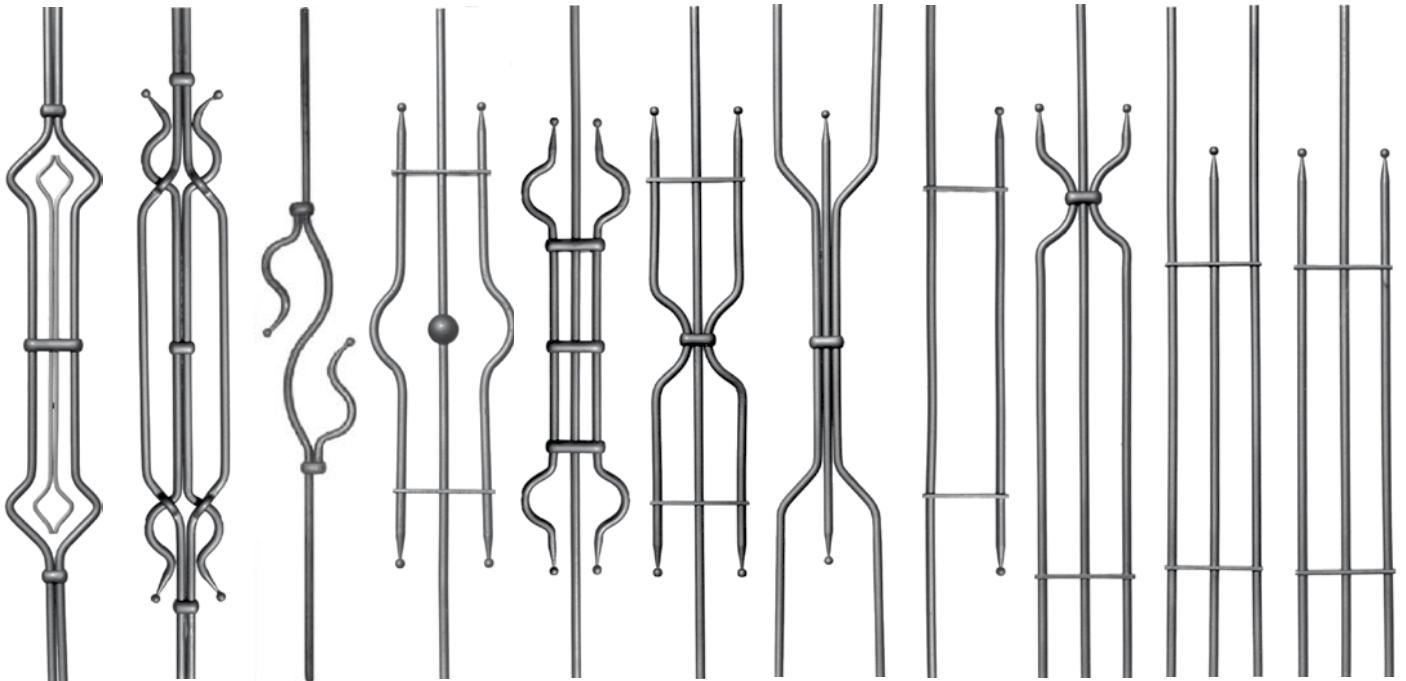

Best.-Nr.	Best.-Nr.	Best.-Nr.	Best.-Nr.	Best.-Nr.	Best.-Nr.	Best.-Nr.	Best.-Nr.	Best.-Nr.	Best.-Nr.	Best.-Nr.
5509	5510	5520	5519	5516	5517	5518	5504	5511	5515	5514
130 x 540 mm	125 x 660 mm	125 x 355 mm	190 x 600 mm	140 x 600 mm	125 x 600 mm	140 x 600 mm	105 x 600 mm	125 x 700 mm	125 x 700 mm	125 x 700 mm
2,50 kg	3,12 kg	1,50 kg	2,14 kg	2,18 kg	2,26kg	2,39 kg	1,53 kg	2,43 kg	2,56 kg	2,32 kg

AK FER



Best.-Nr.
6512
144x600 mm
1,03 kg



Best.-Nr.
6513
144x1000 mm
1,75 kg



Best.-Nr.
6514
144x1500 mm
2,65 kg

Best.-Nr.
6515
134x600 mm
1,01 kg

Best.-Nr.
6516
134x1000 mm
1,73 kg

Best.-Nr.
6517
134x1500 mm
2,63 kg



Länge / Longueur Length / Lunghezza Uzunluk /mm	Material / Matériau Material / Materiale Malzeme	Best.-Nr.
600	Ø12	6519
1000	Ø12	6520
1500	Ø12	6521
600	12 x 12	6522
1000	12 x 12	6523
1500	12 x 12	6524

Top



Best.-Nr.
6501
155 x 90 mm
0,38 kg



Best.-Nr.
6500
190 x 100 mm
0,45 kg



Best.-Nr.
6509
120 x 85 mm
0,30 kg



Best.-Nr.
6510
160 x 100 mm
0,35 kg



Best.-Nr.
6511
220 x 105 mm
0,38 kg



Best.-Nr.
6502
165x60 mm
0,15 kg



Best.-Nr.
6505
120 x 110 mm
0,23 kg



Best.-Nr.
6504
130 x 100 mm
0,22 kg



Best.-Nr.
6507
180 x 115 mm
0,35 kg



Best.-Nr.
6508
155 x 100 mm
0,32 kg



Best.-Nr.
6506
115x120 mm
0,24 kg



Best.-Nr.
6503
215x90 mm
0,29 kg

AK FER

U- Bunde / Colliers en U / U-Collars / Collari a U / U-Bilezikler

Material 12 x 3 mm

Für / for / pour mm	Best.-Nr.
12 x 12	6021
18 x 12	6022
24 x 12	6023

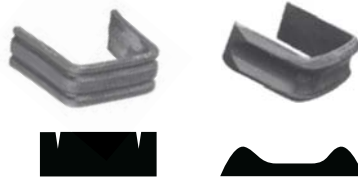

U-Bund überlappend / Colliers en U à rabattre U-Collar overlapped / Collari a U ribattuti U-Bilezik binmeli Material 14 x 4 mm

Für / for / pour mm	Best.-Nr.
12 x 12	6080
18 x 12	6081
24 x 12	6082

Material 16 x 3 mm

Für / for / pour mm	Best.-Nr.
12 x 12	6026
18 x 12	6027
24 x 12	6028
36 x 12	6029
16 x 16	6096
24 x 16	6097
32 x 16	6098

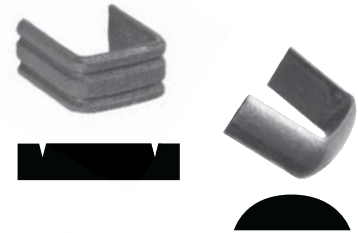

Material 16 x 5 mm, für/for/pour ● 12 mm

Für / for / pour mm	Best.-Nr.
12 x 12	6090
18 x 12	6091
24 x 12	6092
36 x 12	6093
48 x 12	6094
60 x 12	6095

Material 12 x 3 mm, für/for/pour ● 12 mm

Für / for / pour mm	Best.-Nr.
24 x 12	6083
36 x 12	6084



AK FER

Achtung: Angabe der „Für Abmessung“
bezieht sich auf das zu bindende Material!

AK FER

Zierstäbe, glatt / Balustres, lisses / Ornamental balusters, plain edges
Balaustre decorative, semplici / Motifli çubuklar-düz

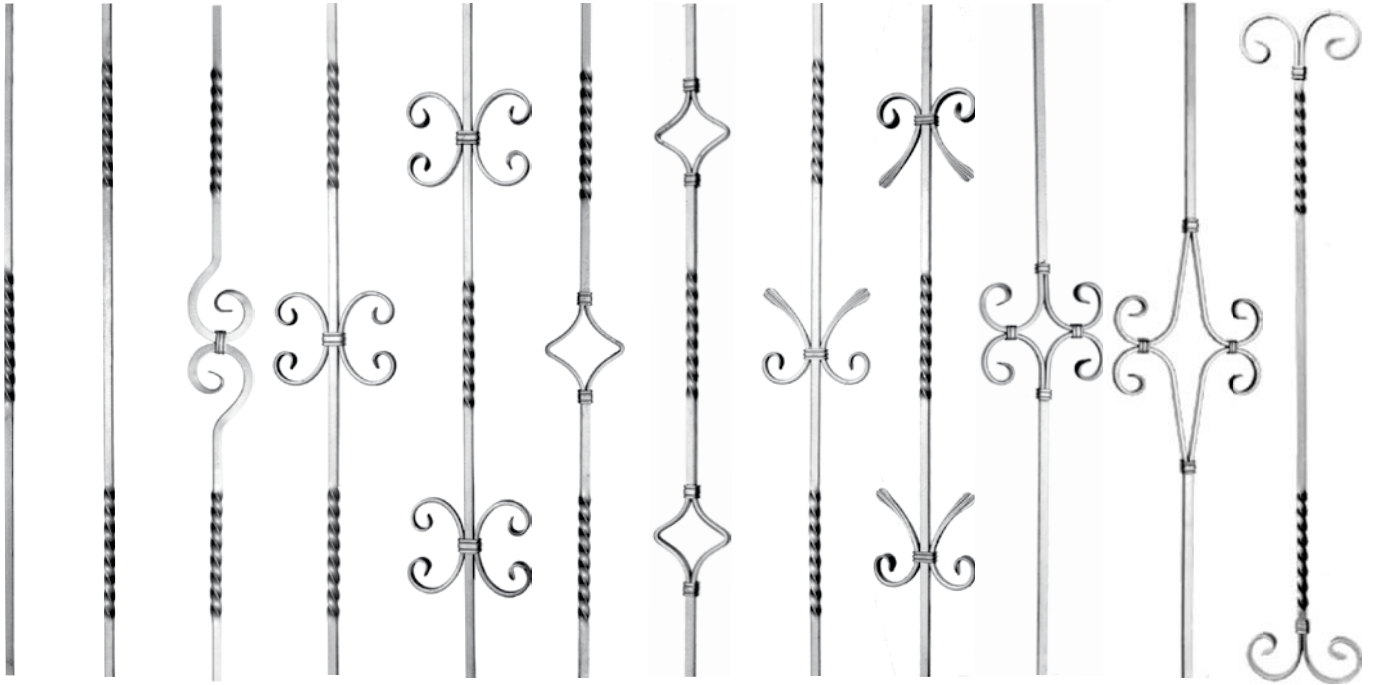

Best.-Nr. 5001 15 x 160 mm 1,00 kg	Best.-Nr. 5002 15 x 700 mm 0,99 kg	Best.-Nr. 5008 80 x 200 mm 1,30 kg	Best.-Nr. 5014 150 x 120 mm 1,36 kg	Best.-Nr. 5015 150 x 640 mm 1,67 kg	Best.-Nr. 5009 100 x 120 mm 1,06 kg	Best.-Nr. 5010 100 x 640 mm 1,16 kg	Best.-Nr. 5037 130 x 120 mm 1,24 kg	Best.-Nr. 5038 130 x 640 mm 1,52 kg	Best.-Nr. 5011 150 x 160 mm 1,31 kg	Best.-Nr. 5013 190 x 320 mm 1,34 kg	Best.-Nr. 5006 160 x 900 mm 1,33 kg
--	--	--	---	---	---	---	---	---	---	---	---

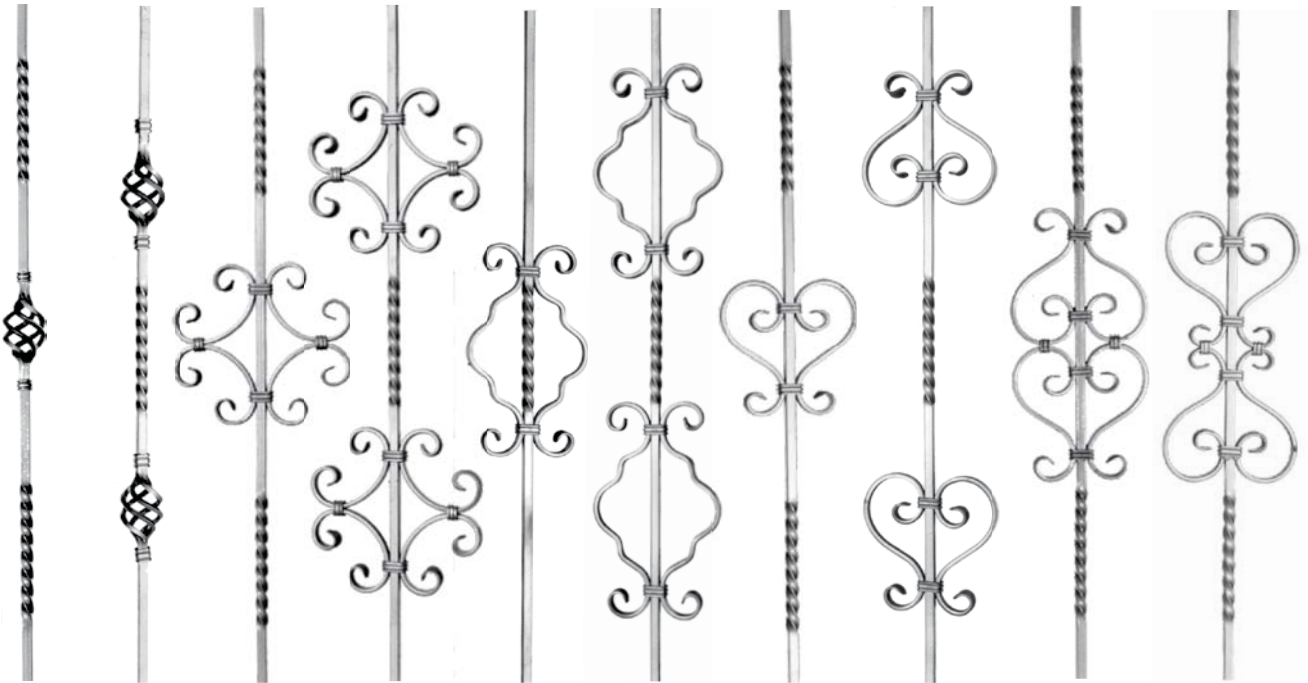

Best.-Nr. 5007 60 x 80 mm 1,06 kg	Best.-Nr. 5046 60 x 540 mm 1,13 kg	Best.-Nr. 5018 220 x 210 mm 1,69 kg	Best.-Nr. 5019 220x640 mm 2,45 kg	Best.-Nr. 5040 160 x 270 mm 1,59 kg	Best.-Nr. 5041 160 x 700 mm 2,17 kg	Best.-Nr. 5031 170 x 170 mm 1,53 kg	Best.-Nr. 5030 170 x 640 mm 1,98 kg	Best.-Nr. 5026 170 x 340 mm 2,00 kg	Best.-Nr. 5027 170 x 340 mm 2,00 kg
---	--	---	---	---	---	---	---	---	---

AK FER

Zierstäbe, glatt / Balustres, lisses / Ornamental balusters, plain edges
Balaustre decorative, semplici / Motifli çubuklar-düz

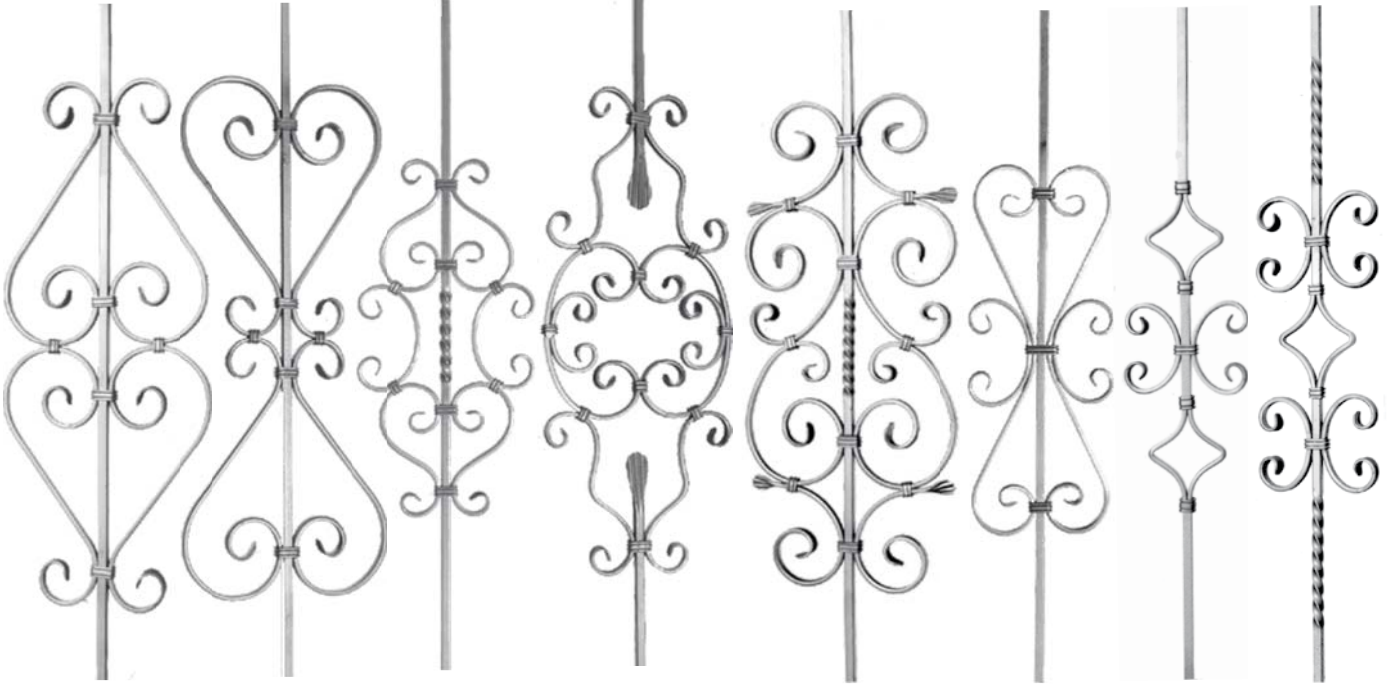

Best.-Nr.
5028
270 x 660 mm
2,75 kg

Best.-Nr.
5029
270 x 660 mm
2,75 kg

Best.-Nr.
5045
230 x 460 mm
2,49 kg

Best.-Nr.
5022
250 x 620 mm
2,64 kg

Best.-Nr.
5047
280 x 620 mm
3,42 kg

Best.-Nr.
5050
185 x 475 mm
2,32 kg

Best.-Nr.
5043
150 x 375 mm
1,53 kg

Best.-Nr.
5044
150 x 375 mm
1,77 kg

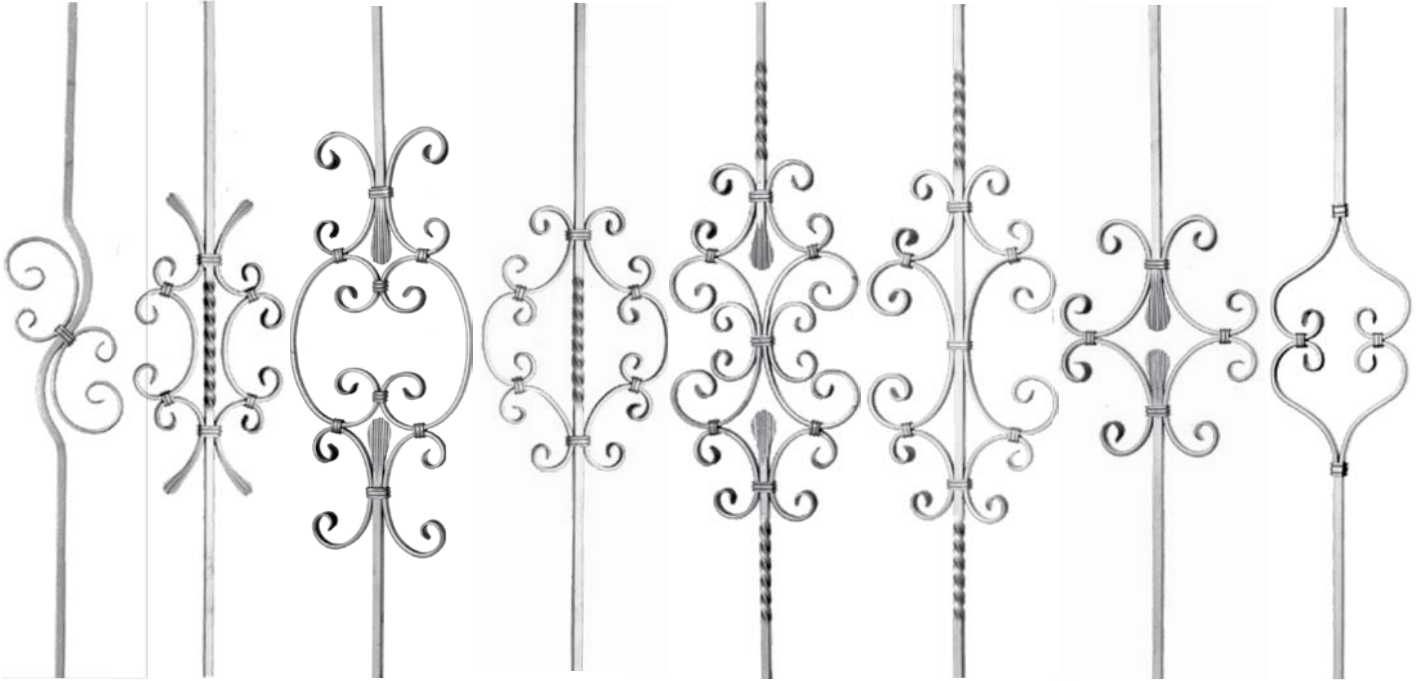

Best.-Nr.
5051
150 x 250 mm
1,47 kg

Best.-Nr.
5039
185 x 360 mm
1,97 kg

Best.-Nr.
5023
250 x 540 mm
2,32 kg

Best.-Nr.
5017
250 x 340 mm
2,10 kg

Best.-Nr.
5021
250 x 450 mm
2,57 kg

Best.-Nr.
5016
250 x 450 mm
2,41 kg

Best.-Nr.
5024
250 x 300 mm
1,90 kg

Best.-Nr.
5012
180 x 320 mm
1,33 kg

Zierstäbe, kantengehämmt / Balustres, Martelé

Ornamental balusters, Hammered edges / Balaustre, Bordi martellati / Köşe dövme motifli çubuklar

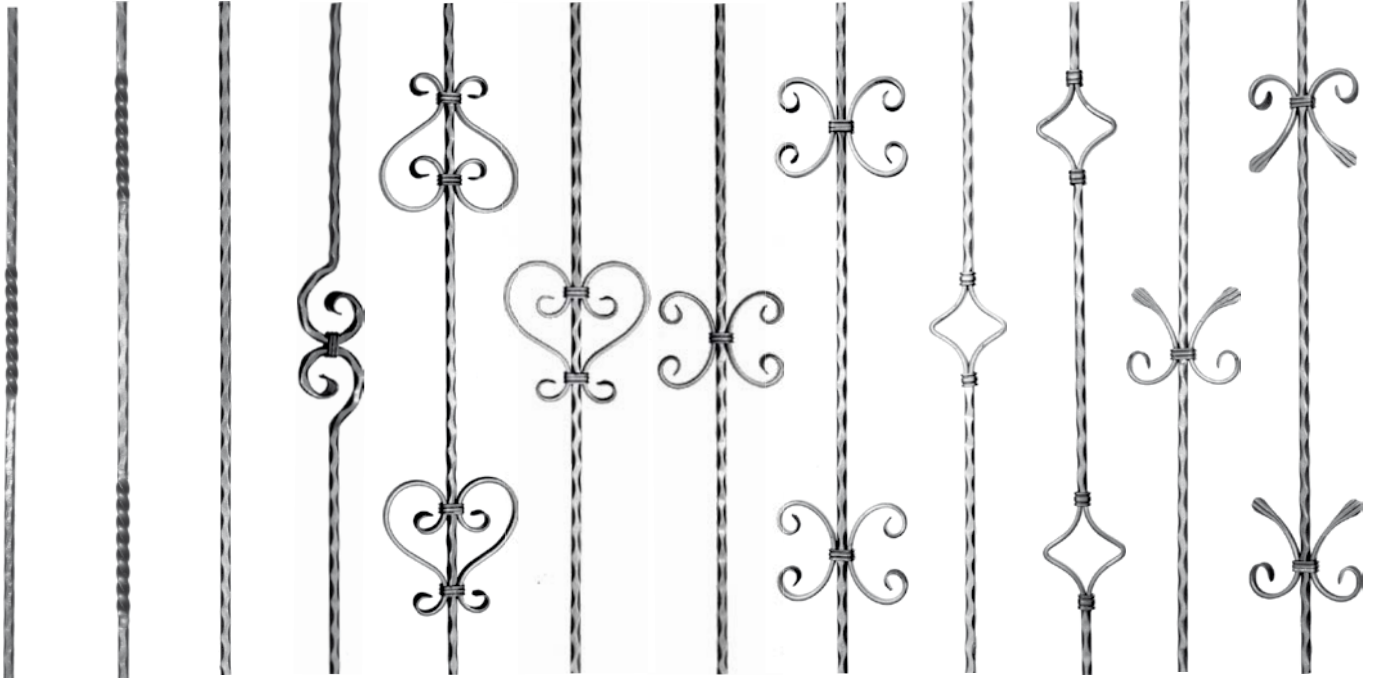

Best.-Nr. 5101 15 x 160 mm 0,98 kg	Best.-Nr. 5102 15 x 700 mm 0,98 kg	Best.-Nr. 5100 12 x 900 mm 0,92 kg	Best.-Nr. 5108 80 x 200 mm 1,14 kg	Best.-Nr. 5130 170 x 640 mm 1,84 kg	Best.-Nr. 5131 170 x 170 mm 1,34 kg	Best.-Nr. 5114 150 x 120 mm 1,24 kg	Best.-Nr. 5115 150 x 640 mm 1,61 kg	Best.-Nr. 5109 100 x 120 mm 1,00 kg	Best.-Nr. 5110 100 x 640 mm 1,06 kg	Best.-Nr. 5137 130 x 120 mm 1,07 kg	Best.-Nr. 5138 130 x 640 mm 1,34 kg
--	--	--	--	---	---	---	---	---	---	---	---

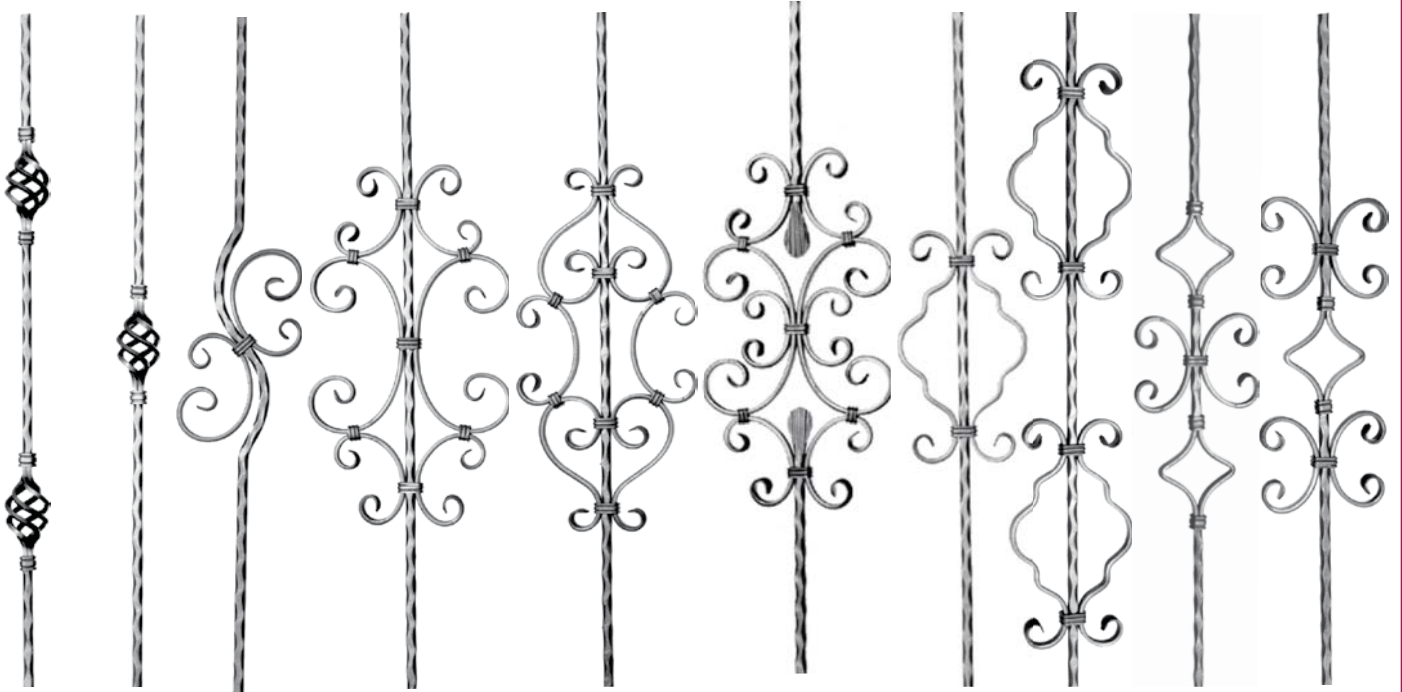

Best.-Nr. 5146 60 x 540 mm 1,08 kg	Best.-Nr. 5107 60 x 80 mm 0,96 kg	Best.-Nr. 5151 150 x 250 mm 1,45 kg	Best.-Nr. 5116 250 x 450 mm 2,34 kg	Best.-Nr. 5145 230 x 460 mm 2,31 kg	Best.-Nr. 5121 250 x 450 mm 2,47 kg	Best.-Nr. 5140 160 x 270 mm 1,40 kg	Best.-Nr. 5141 160 x 700 mm 1,96 kg	Best.-Nr. 5143 150 x 375 mm 1,40 kg	Best.-Nr. 5144 150 x 375 mm 1,69 kg
--	---	---	---	---	---	---	---	---	---

Zierstäbe, kantengehämert / Balustres, Martelé

Ornamental balusters, Hammered edges / Balaustre, Bordi martellati / Köşe dövme motifli çubuklar

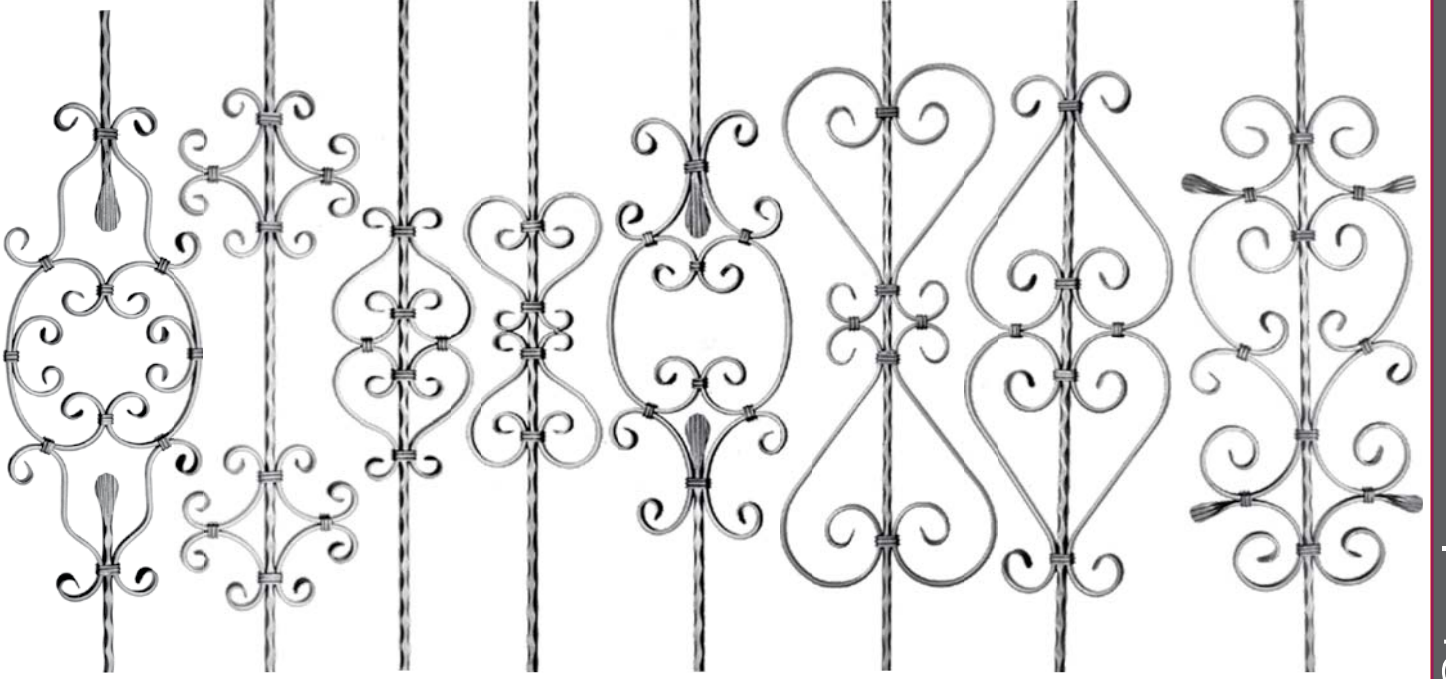

Best.-Nr.

5122

250 x 620 mm
2,61 kg

Best.-Nr.

5119

220 x 640 mm
2,33 kg

Best.-Nr.

5126

170 x 340 mm
1,85 kg

Best.-Nr.

5127

170 x 340 mm
1,85 kg

Best.-Nr.

5123

250 x 540 mm
2,39 kg

Best.-Nr.

5129

270 x 660 mm
2,65 kg

Best.-Nr.

5128

270 x 660 mm
2,65 kg

Best.-Nr.

5147

280 x 620 mm
3,37 kg

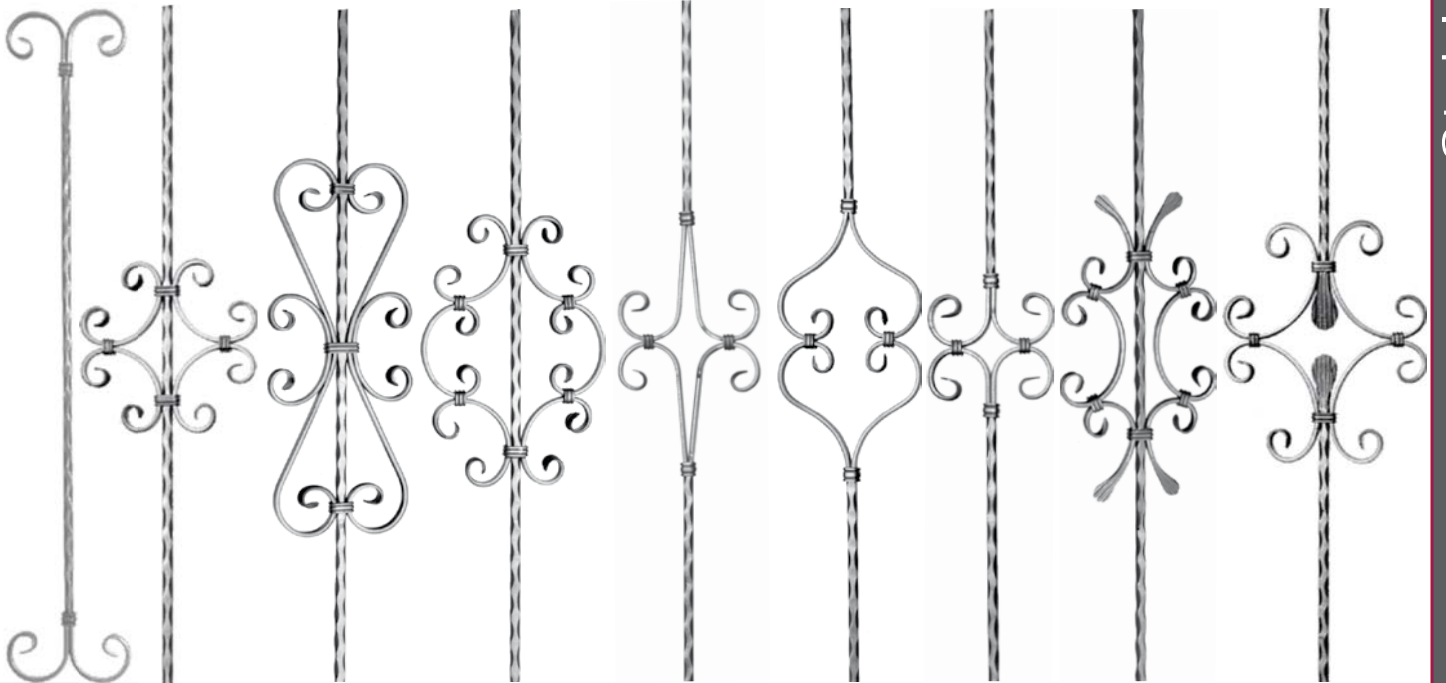

Best.-Nr.

5106

160 x 900 mm
1,25 kg

Best.-Nr.

5118

220 x 210 mm
1,59 kg

Best.-Nr.

5150

185 x 475 mm
2,27 kg

Best.-Nr.

5117

250 x 340 mm
2,00 kg

Best.-Nr.

5113

190 x 320 mm
1,35 kg

Best.-Nr.

5112

180 x 320 mm
1,26 kg

Best.-Nr.

5111

150 x 160 mm
1,27 kg

Best.-Nr.

5139

185 x 360 mm
1,77 kg

Best.-Nr.

5124

250 x 300 mm
1,81 kg

AK FER

Leichtbarock- Zierstäbe, glatt / Balustres lisses baroque léger
Light Baroque balusters, plain edges / Barra semplice a motivo barocco
Hafif Barok motifli çubuklar, düz



Best.-Nr.
5206
180 x 340 mm
1,41 kg



Best.-Nr.
5207
170 x 180 mm
1,34 kg



Best.-Nr.
5205
195 x 320 mm
1,38 kg



Best.-Nr.
5203
170 x 120 mm
1,39 kg



Best.-Nr.
5204
170 x 640 mm
1,82 kg



Best.-Nr.
5225
260 x 290 mm
1,92 kg



Best.-Nr.
5210
170 x 410 mm
1,54 kg



Best.-Nr.
5211
170 x 375 mm
1,88 kg



Best.-Nr.
5224
170 x 900 mm
1,35 kg



Best.-Nr.
5219
260 x 450 mm
2,59 kg



Best.-Nr.
5218
250 x 530 mm
2,44 kg

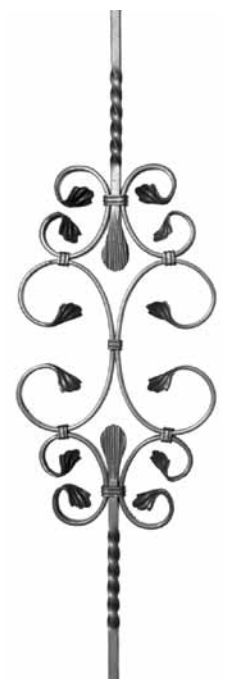

Best.-Nr.
5220
240 x 450 mm
2,31 kg

AK FER

Leichtbarock- Zierstäbe, glatt / Balustres lisses baroque léger
Light Baroque balusters, plain edges / Barra semplice a motivo barocco
Hafif Barok motifli çubuklar, düz



Best.-Nr.
5208
220 x 220 mm
1,84 kg



Best.-Nr.
5209
220 x 640 mm
2,60 kg



Best.-Nr.
5214
250 x 340 mm
2,24 kg



Best.-Nr.
5212
210 x 460 mm
2,11 kg



Best.-Nr.
5213
240 x 460 mm
2,46 kg



Best.-Nr.
5201
280 x 620 mm
3,33 kg

AK FER



Best.-Nr.
5223
300 x 620 mm
3,23 kg

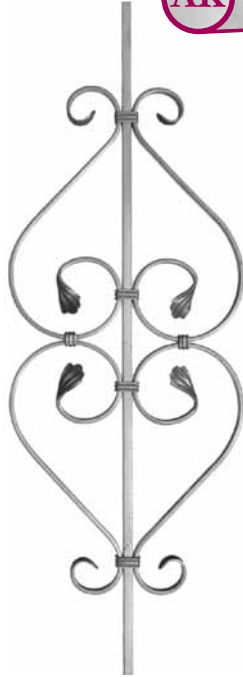

Best.-Nr.
5221
290 x 660 mm
2,70 kg

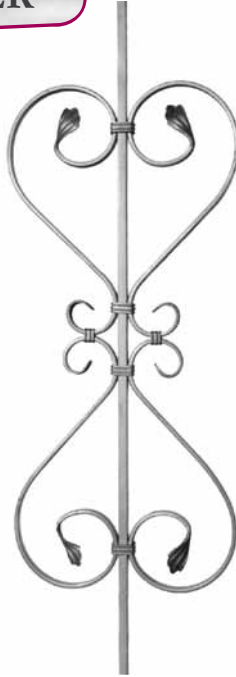

Best.-Nr.
5222
290 x 660 mm
2,70 kg

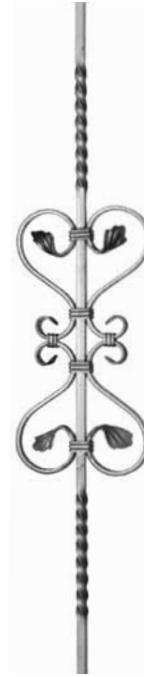

Best.-Nr.
5217
170 x 340 mm
1,95 kg



Best.-Nr.
5216
170 x 340 mm
1,95 kg

AK FER

Leichtbarock- Zierstäbe, kantengehäm. / Balustres baroque léger, martelées
Light Baroque balusters, hammered / Balaustre decorative, bordi martellati
Hafif Barok motifli çubuklar, köşe dövme



Best.-Nr.
5100
12 x 900 mm
0,92 kg



Best.-Nr.
5101
15 x 160 mm
0,98 kg



Best.-Nr.
5102
15 x 700 mm
0,98 kg



Best.-Nr.
5325
260 x 290 mm
1,84 kg



Best.-Nr.
5314
250 x 340 mm
2,20 kg



Best.-Nr.
5316
170 x 340 mm
1,85 kg

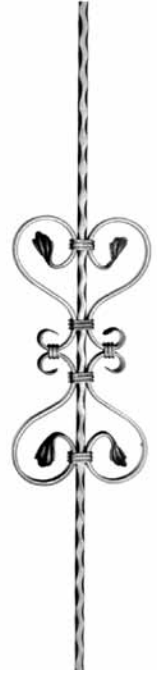

Best.-Nr.
5317
170 x 340 mm
1,79 kg



Best.-Nr.
5313
240 x 460 mm
2,32 kg

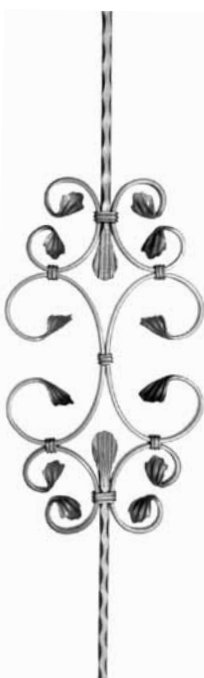

Best.-Nr.
5320
240 x 450 mm
2,28 kg



Best.-Nr.
5321
290 x 660 mm
2,70 kg

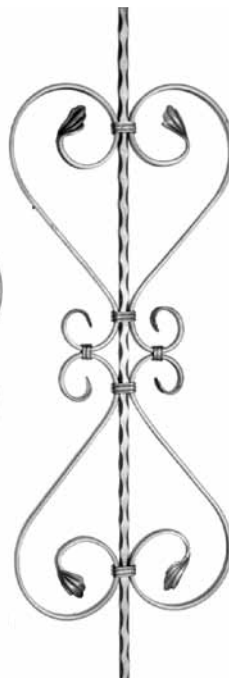

Best.-Nr.
5322
290 x 660 mm
2,70 kg



Best.-Nr.
5323
300 x 620 mm
3,28 kg



Best.-Nr.
5301
280 x 620 mm
3,27 kg

AK FER

Leichtbarock- Zierstäbe, kantengehäm. / Balustres baroque léger, martelées
Light Baroque balusters, hammered / Balaustre decorative, bordi martellati
Hafif Barok motifli çubuklar, köşe dövme

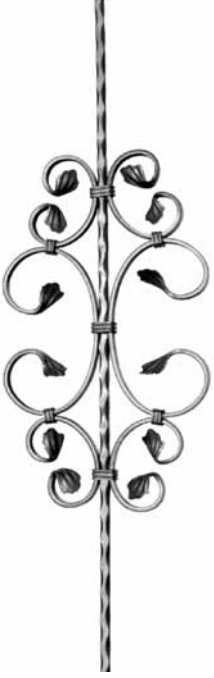

Best.-Nr.
5319
260 x 450 mm
2,47 kg



Best.-Nr.
5305
195 x 320 mm
1,35 kg



Best.-Nr.
5306
180 x 340 mm
1,29 kg

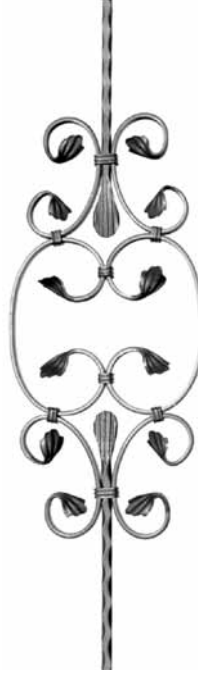

Best.-Nr.
5318
250 x 340 mm
2,45 kg



Best.-Nr.
5303
170 x 120 mm
1,27 kg



Best.-Nr.
5304
170 x 640 mm
1,66 kg



Best.-Nr.
5310
170 x 375 mm
1,47 kg



Best.-Nr.
5311
170 x 375 mm
1,83 kg



Best.-Nr.
5308
220 x 220 mm
1,70 kg

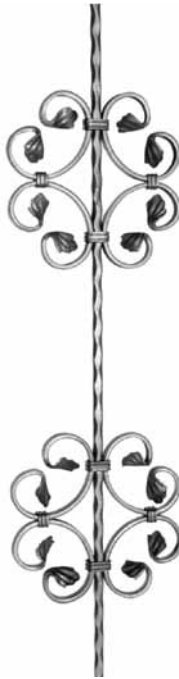

Best.-Nr.
5309
220 x 640 mm
2,68 kg



Best.-Nr.
5312
210 x 400 mm
2,05 kg



Best.-Nr.
5307
170 x 180 mm
1,29 kg



Best.-Nr.
5324
170 x 900 mm
1,25 kg

AK FER

Schmiedestäbe / Balustres forgées
Forged balusters / Barre per balaustre, forgiate / Dövme çubuklar

Länge / Longueur / Length / Lunghezza / Uzunluk: 1000 mm

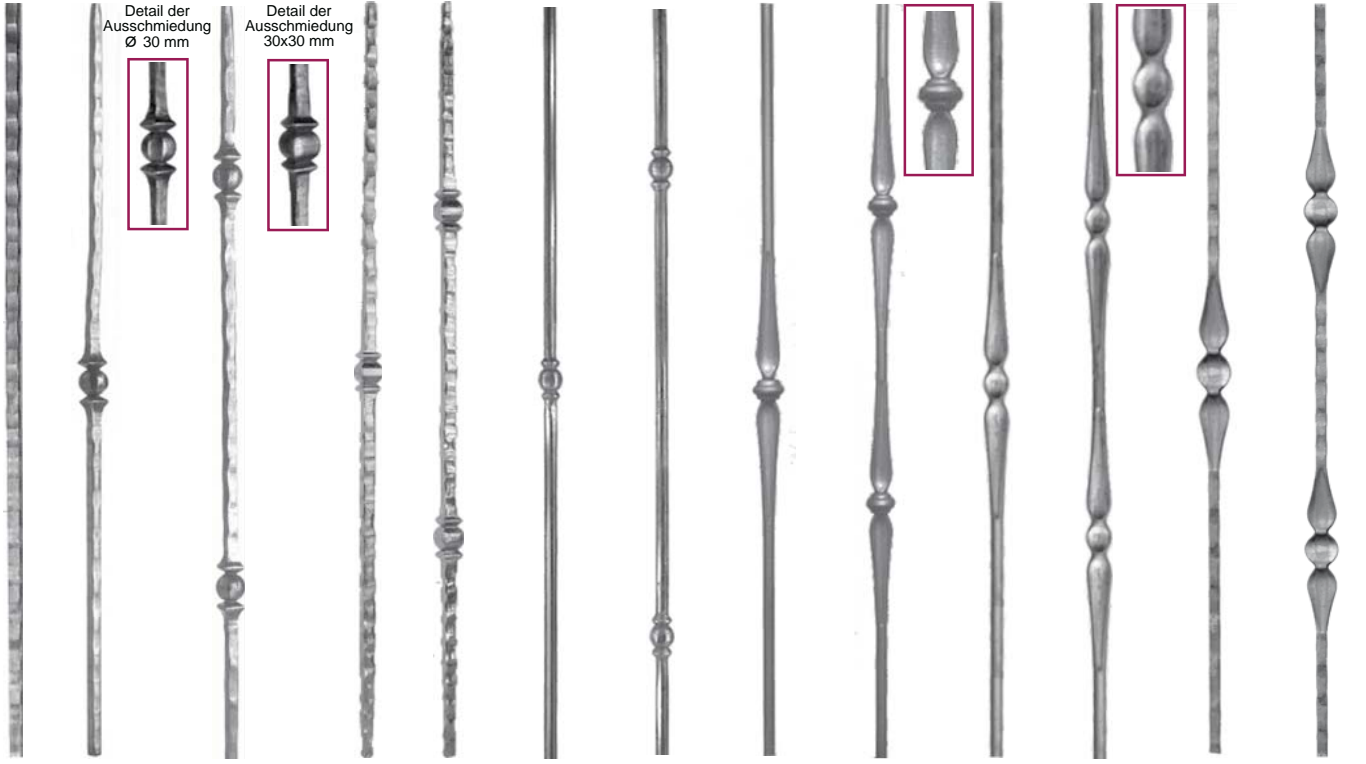

Best.-Nr. 5442 12x12 mm 1,10kg	Best.-Nr. 5401 12x12 mm 1,50kg	Best.-Nr. 5406 12x12 mm 1,80 kg	Best.-Nr. 5410 12x12 mm 1,55 kg	Best.-Nr. 5411 12x12 mm 1,95 kg	Best.-Nr. 5434 ø 12 mm 1,06 kg	Best.-Nr. 5435 ø 12 mm 1,10 kg	Best.-Nr. 5417 ø 14 mm 1,25 kg	Best.-Nr. 5418 ø 14 mm 1,30 kg	Best.-Nr. 5415 ø 14 mm 1,20 kg	Best.-Nr. 5414 ø 14 mm 1,20 kg	Best.-Nr. 5412 12x12 mm 1,10 kg	Best.-Nr. 5413 12x12 mm 1,10 kg
--	--	---	---	---	--	--	--	--	--	--	---	---

Länge / Longueur / Length / Lunghezza / Uzunluk: 1000 mm

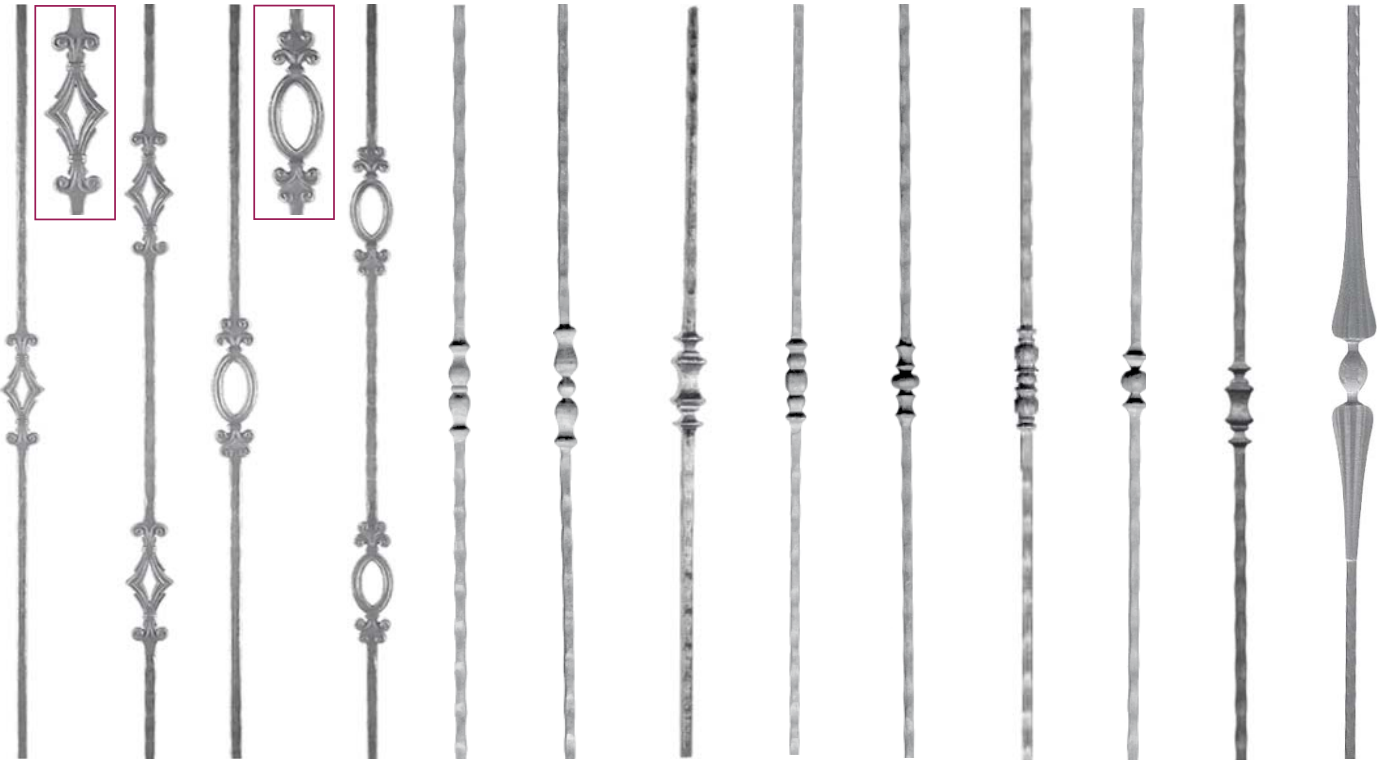

Best.-Nr. 5421 14 x14 mm 1,65 kg	Best.-Nr. 5425 14x14 mm 1,80 kg	Best.-Nr. 5422 14x14 mm 1,65 kg	Best.-Nr. 5428 14x14 mm 1,80 kg	Best.-Nr. 5400 12x12 mm 1,30 kg	Best.-Nr. 5402 12x12 mm 1,65 kg	Best.-Nr. 5436 14x14 mm 2,11 kg	Best.-Nr. 5407 12x12 mm 1,65 kg	Best.-Nr. 5404 12x12 mm 1,55 kg	Best.-Nr. 5408 12x12 mm 1,70 kg	Best.-Nr. 5409 13 x13 mm 1,24 kg	Best.-Nr. 5405 12x12 mm 1,65 kg	Best.-Nr. 5416 14x14 mm 1,50 kg
--	---	---	---	---	---	---	---	---	---	--	---	---

AK FER

Schmiedestäbe / Balustres forgées
Forged balusters / Barre per balaustre, forgiate / Dövme çubuklar

Länge / Longueur / Length / Lunghezza / Uzunluk: 1000 mm

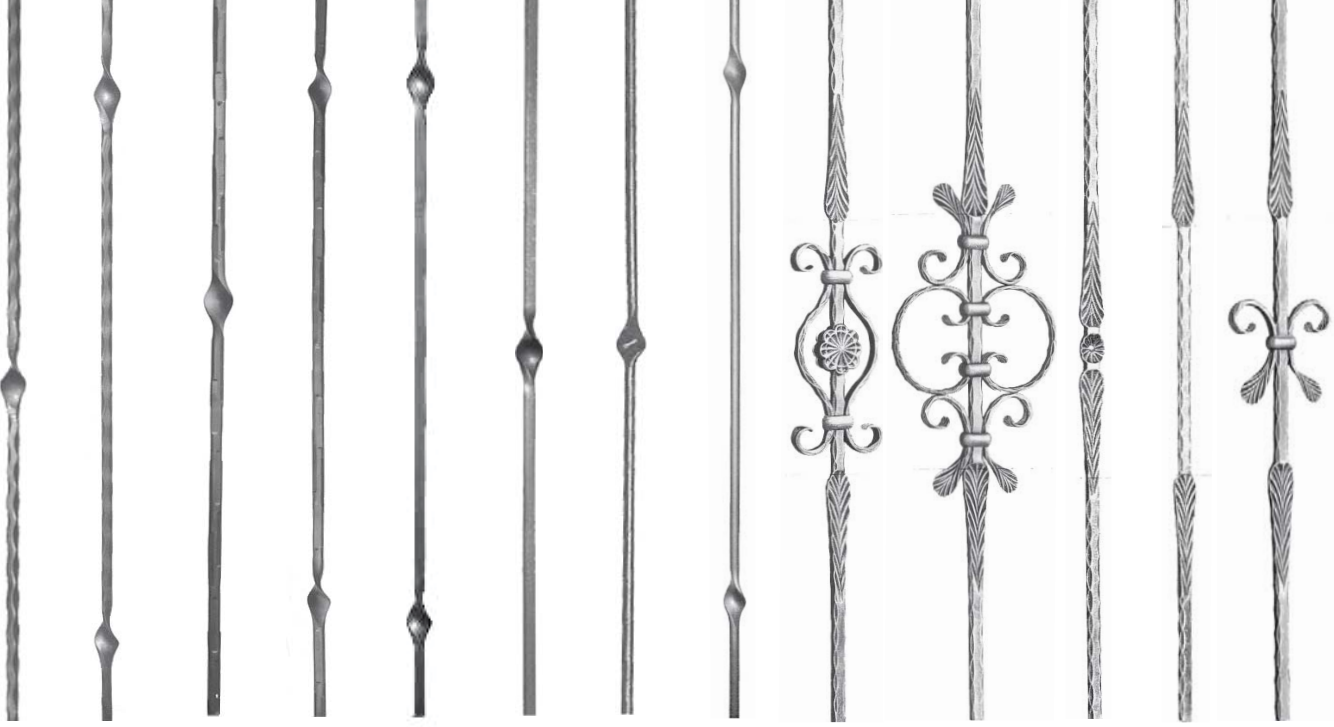

Best.-Nr. 5430 12x12 mm kantengeh. 1,00 kg	Best.-Nr. 5431 12x12 mm kantengeh. 1,00 kg	Best.-Nr. 5440 ø 14 mm gehämmert 1,08 kg	Best.-Nr. 5441 ø 14 mm gehämmert 1,08 kg	Best.-Nr. 5423 12x12 mm 1,00 kg	Best.-Nr. 5424 12x12 mm 1,00 kg	Best.-Nr. 5426 ø 12 mm 0,80 kg	Best.-Nr. 5427 ø 12 mm 0,80 kg	Best.-Nr. 5438 12x12 mm 1,75 kg	Best.-Nr. 5439 12x12 mm 2,01 kg	Best.-Nr. 5419 12x12 mm kantengeh. 0,98 kg	Best.-Nr. 5420 12x12 mm kantengeh. 1,00 kg	Best.-Nr. 5437 12x12 mm kantengeh. 1,27 kg
---	---	---	---	---	---	--	--	---	---	---	---	---

Länge / Longueur / Length / Lunghezza / Uzunluk: 1000 mm



Best.-Nr. 5480 13 x 13 mm 1,57kg	Best.-Nr. 5481 ø 14 mm 1,57 kg	Best.-Nr. 5482 ø 12 mm 1,06 kg	Best.-Nr. 5483 ø 12 mm 1,22 kg	Best.-Nr. 5484 ø 12 mm 1,02 kg	Best.-Nr. 5485 ø 12 mm 1,14 kg	Best.-Nr. 5486 ø 12 mm 1,18 kg	Best.-Nr. 5487 12x12 mm 1,13 kg	Best.-Nr. 5488 12x12 mm 1,13 kg	Best.-Nr. 5489 ø 12 mm 1,14 kg	Best.-Nr. 5490 ø 12 mm 1,28 kg
--	--	--	--	--	--	--	---	---	--	--

Akbas

Konkrek & Metal Ürünleri



Bauschlosserei Höcst GmbH & Co. KG, D - 35510 Butzbach



Schlosserei Marco Müller, D - 64753 Brombachtal



Schlosserei Marco Müller, D - 64753 Brombachtal

Stahl St. 37 / Steel



Schlosserei Rupert GraBer, D - 84184 Tiefenbach



Stahl St. 37 / Steel



Schlosserei Marco Müller, D - 64753 Brombachtal



Schlosserei Marco Müller, D - 64753 Brombachtal

Länge / Longueur / Length / Lunghezza / Uzunluk: 1200 mm



Best.-Nr. **8001**
20 x 20 mm
3,79 kg



Best.-Nr. **8006**
20 x 20 mm
4,07 kg



Best.-Nr. **8003**
20 x 20 mm
kantengehämmert
3,67 kg



Best.-Nr. **8008**
20 x 20 mm
4,12 kg



Best.-Nr. **8009**
20 x 20 mm
kantengehämmert
3,79 kg



Best.-Nr. **8014**
25 x 25 mm
4,90 kg



Best.-Nr. **8017**
25x25 mm
kantengehämmert
5,90 kg



Best.-Nr. **8015**
25 x 25 mm
7,30 kg



Best.-Nr. **8019**
25 x 25 mm
5,90 kg



Best.-Nr. **8016**
25 x 25 mm
6,70 kg



Best.-Nr. **8020**
ø 25 mm
4,60 kg



Best.-Nr. **8018**
25 x 25 mm
5,85 kg



Best.-Nr. **8021**
25 x 25 mm
4,70 kg



Best.-Nr. **8022**
ø 25 mm
5,92 kg



Best.-Nr. **8023**
ø 25 mm
5,49 kg



Best.-Nr. **8024**
ø 28 mm
6,32 kg



Stahl St. 37 / Steel

Vierkanteisen, kantengehämmt
Barreaux quadrangulaires, martelés
Square steel bar, hammered edges
Barra quadrangolare, bordi martellati
Köşe dövmei dörtköşeler

Länge / Longueur
Length / Lunghezza / Uzunluk
3000 mm



Abmessungen /Mesure	kg /m	Best.-Nr.
12x12 mm	1,05	11001
14x14 mm	1,42	11004
16x16 mm	1,85	11002
20x20 mm	2,92	11003
25x25 mm	4,56	11005

Vierkantrohr, kantengehämmt
Tubes quadrangulaires, martelés
Rectangle tubes, hammered edges
Tubi rettangolari con spigoli martellati
Köşe dövmei profiller

Länge / Longueur
Length / Lunghezza / Uzunluk : 3000 mm



Abmessungen /Mesure	kg /m	Best.-Nr.
20 x 20 x 2,0 mm	1,00	11500
25 x 25 x 2,0 mm	1,33	11511
30 x 20 x 2,0 mm	1,33	11501
30 x 30 x 2,5 mm	2,10	11502
40 x 20 x 2,5 mm	2,10	11503
40 x 30 x 2,5 mm	2,33	11504
40 x 40 x 2,5 mm	2,83	11505
50 x 30 x 2,5 mm	2,83	11506
60 x 40 x 2,5 mm	3,77	11507
60 x 60 x 2,5 mm	5,30	11508
80 x 80 x 3,0 mm	7,00	11509
100 x 100 x 3,5 mm	8,60	11510

Spießkantig abgehämmt, somit absolut keine scharfen Kanten!

Tubes quadrangulaires : Bords adoucis!
Rectangle tubes: No sharp edges!
Tubi rettangolari: Spigoli smussati!
Keskin olmayan dört köşe demirler

Bundeisen und Stangenware / Colliers et barreaux
Collars and bars / Collari e barre / Bilezik ve Çubuklar

Handlauf / Main courante
Handrail / Corrimano / Lamalar

Länge / Longueur
Length / Lunghezza
Uzunluk

Abmessung / Dimension
Dimension / Dimension
Ölçü

Best.-Nr.

	Bundeisen	2500 mm	12 x 3 mm	11300
	Bundeisen	2500 mm	16 x 3 mm	11301
	Bundeisen	3000 mm	13 x 3 mm	11302
	Bundeisen	4000 mm	16 x 5 mm	11303
	Vierkanteisen, gerillt 1,05 kg/m	3000 mm	12 x 12 mm	11202
	Flacheisen beidseitig gerillt 0,94 kg/m	3000 mm	16 x 8 mm	11201
	Flacheisen beidseitig abgehämmt 0,92 kg/m	3000 mm	16 x 8 mm	11101
	Flacheisen, gerillt, beidseitig abgehämmt 2,18 kg/m	3000 mm	30 x 10 mm	11102

Länge / Longueur / Length / Lunghezza / Uzunluk: 3000 mm

Abmessung / Dimension
Dimension / Dimension
Ölçü

kg/m

Best.-Nr.

	40 x 8 mm	2,05	7030
	30 x 8 mm	1,77	7003
	40 x 8 mm	2,35	7004
	50 x 5 mm	1,83	11011
	50 x 8 mm	2,93	7036
	20 x 8 mm	1,18	7001
	25 x 8 mm	1,47	7028
	40 x 5 mm	1,46	11010
	40 x 8 mm	2,35	7002

Gerillt
Rainure sur la tranche
Grooved
Scanalato
Yarmalı

Ohne Rillen!
Sans Rainure
Not Grooved
Senza scanalatura
Düz

Hespeneisen / U-Fer / U-Iron / U-Ferro / U-Demir

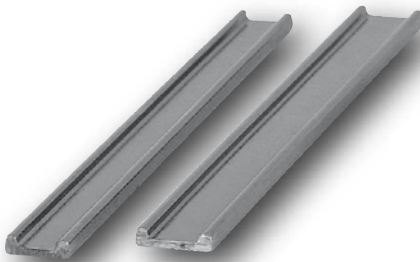

Länge / Longueur Length / Lunghezza Uzunluk /mm	Material / Matériau Material / Materiale Malzeme	Best.-Nr.
3000	25 x 8 mm	11012
3000	30 x 8 mm	11013

Handlaufzubehör ohne Rillen / Accessoires de main-courante sans rainure
Handrail accessories, not grooved / Accessori per corrimano, martellati, non scanalati
Dövmeli küpeşte aksesuarları



Handlauf-Anfang
Best.-Nr. 7017
 400 x 150 mm
 1,65 kg



Handlauf-Anfang
Best.-Nr. 7006
 730 x 150 mm
 2,20 kg



Handlauf-Anfang
Best.-Nr. 7016
 750 x 320 mm
 2,30 kg



Krümmer
 290 x 290 mm

Best.-Nr. 7008
 20 x 8 mm, 0,60 kg

Best.-Nr. 7029
 25 x 8 mm, 0,75 kg

Best.-Nr. 7009
 40 x 8 mm, 1,20 kg



Handlauf-Anfang
Best.-Nr. 7007
 250 x 115 mm
 Aus 40 x 8 mm,
 0,90 kg



Handlauf-Anfang
Best.-Nr. 7026
 140 x 60 mm
 Aus 40 x 8 mm,
 0,47 kg

Handlaufzubehör mit Rillen / Accessoire de main-courante avec rainure
Grooved handrail termination / Accessorio lavorato per corrimano
Yarmalı küpeşte sonlandırıcısı



Handlauf-Anfang
Best.-Nr. 7019
 400 x 150 mm
 1,65 kg



Handlauf-Anfang
Best.-Nr. 7018
 750 x 320 mm
 2,30 kg



Handlauf-Anfang
Best.-Nr. 7010
 Aus 40 x 8 mm
 730 x 150 mm, 2,20 kg

Best.-Nr. 7038
 Aus 50 x 8 mm
 730 x 150 mm, 2,75 kg



Handlauf-Anfang
Best.-Nr. 7011
 Aus 40 x 8 mm,
 0,90 kg

Best.-Nr. 7037
 Aus 50 x 8 mm,
 1,13 kg



Handlauf-Ende
Best.-Nr. 7027
 140 x 60 mm
 Aus 40 x 8 mm,
 0,47 kg

Best.-Nr. 7035
 Aus 50 x 8 mm,
 0,60 kg



Krümmer
 290 x 290 mm
Best.-Nr. 7013
 Aus 30 x 8 mm,
 0,9 kg

Best.-Nr. 7014
 Aus 40 x 8 mm,
 1,20 kg

Handlaufzubehör mit Rillen
Accessoire de main-courante avec rainure
Grooved handrail termination
Accessorio lavorato per corrimano
Yarmalı küpeşte sonlandırıcısı



Handlauf-Anfang
Best.-Nr. 7031
 250 x 115 mm
 0,80 kg



Krümmer
Best.-Nr. 7033
 Aus 40 x 8 mm
 290 x 290 mm
 1,06 kg



Handlauf-Anfang
Best.-Nr. 7032
 730 x 150 mm
 1,94 kg

Handlaufzubehör
Support de main-courante / Handrail bracket
Supporto per corrimano / Duvar kolçağı



Handlaufträger
Best.-Nr. 7125
 Platte ø 90 mm



Handlaufträger
Best.-Nr. 7126
 Platte ø 90 mm



Handlaufträger
Best.-Nr. 7122
 110 x 190 mm
 0,52 kg

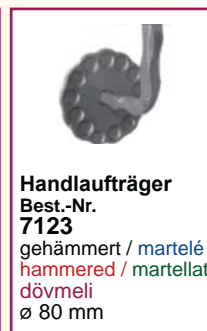

Handlaufträger
Best.-Nr. 7123
 gehämmert / martelé
 hammered / martellato
 dövmeli
 ø 80 mm

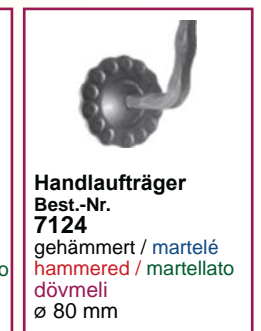

Handlaufträger
Best.-Nr. 7124
 gehämmert / martelé
 hammered / martellato
 dövmeli
 ø 80 mm



Korbstab aus 12x12 mm
glatt / lisse / plain / piatto / düz
Ausbauchung / Renflement
Belly / Concavo / Derinlik 180 mm

Länge/mm	Best.-Nr.
900	4001
1350	4002
1500	4003

Korbstab aus 12x12 mm
gehämmert / martelé / hammered / martellato / dövme- Ausbauchung / Renflement
Belly / Concavo / Derinlik 180 mm

Länge/mm	Best.-Nr.
900	4101
1350	4102
1500	4103



Korbstab aus 12x12 mm
glatt / lisse / plain / piatto / düz
Ausbauchung / Renflement
Belly / Concavo / Derinlik 180 mm

Länge/mm	Best.-Nr.
900	4016
1350	4017
1500	4018

Korbstab aus 12x12 mm
gehämmert / martelé / hammered / martellato / dövme- Ausbauchung / Renflement
Belly / Concavo / Derinlik 180 mm

Länge/mm	Best.-Nr.
900	4116
1350	4117
1500	4118



Korbstab aus 12x12 mm
glatt / lisse / plain / piatto / düz
Ausbauchung / Renflement
Belly / Concavo / Derinlik 180 mm

Länge/mm	Best.-Nr.
900	4022
1350	4023
1500	4024

Korbstab aus 12x12 mm
gehämmert / martelé / hammered / martellato / dövme- Ausbauchung / Renflement
Belly / Concavo / Derinlik 180 mm

Länge/mm	Best.-Nr.
900	4122
1350	4123
1500	4124



Korbstab aus 12x12 mm
glatt / lisse / plain / piatto / düz
Ausbauchung / Renflement
Belly / Concavo / Derinlik 180 mm

Länge/mm	Best.-Nr.
900	4028
1350	4029
1500	4030

Korbstab aus 12x12 mm
gehämmert / martelé / hammered / martellato / dövme- Ausbauchung / Renflement
Belly / Concavo / Derinlik 180 mm

Länge/mm	Best.-Nr.
900	4128
1350	4129
1500	4130



Korbstab aus 12x12 mm
glatt / lisse / plain / piatto / düz
Ausbauchung / Renflement
Belly / Concavo / Derinlik 200 mm

Länge/mm	Best.-Nr.
1000	4050
1350	4051
1500	4052

Korbstab aus 12x12 mm
gehämmert / martelé / hammered / martellato / dövme- Ausbauchung / Renflement
Belly / Concavo / Derinlik 200 mm

Länge/mm	Best.-Nr.
1000	4150
1350	4151
1500	4152



Korbstab aus 12x12 mm
glatt / lisse / plain / piatto / düz
Ausbauchung / Renflement
Belly / Concavo / Derinlik 130 mm

Länge/mm	Best.-Nr.
900	4031
1350	4032
1500	4033

Korbstab aus 12x12 mm
gehämmert / martelé / hammered / martellato / dövme- Ausbauchung / Renflement
Belly / Concavo / Derinlik 130 mm

Länge/mm	Best.-Nr.
900	5553
1350	5554
1500	5555



Korbstab aus 12x12 mm
glatt / lisse / plain / piatto / düz
Ausbauchung / Renflement
Belly / Concavo / Derinlik 180 mm

Länge/mm	Best.-Nr.
900	4013
1350	4014
1500	4015



AK FER

Korbstab aus 12x12 mm
glatt / lisse / plain / piatto / düz
Ausbauchung / Renflement
Belly / Concavo / Derinlik 180 mm

Länge/mm	Best.-Nr.
900	4004
1350	4005
1500	4006

Korbstäbe & Zubehör / Barreaux galbés et accessoires
Convex bars & Accessories / Barre piegata e accessori / Cumbalar & Aksesuarlar



Korbstab aus 12x12 mm
 Ausbauchung / Renflement
 Belly / Concavo / Derinlik 110 mm

	Best.-Nr.
glatt	4060
gehämmert	4160



Best.-Nr. 4075
 Aus 25 x 8 mm
 900 mm



Best.-Nr. 4070
 Aus 12 x 12 mm
 900 mm

Best.-Nr. 4071
 Aus 14 x 14 mm
 900 mm

Best.-Nr. 4072
 Aus 14 x 14 mm
 1500 mm



Best.-Nr. 4073
 Aus 14 x 14 mm
 900 mm

Best.-Nr. 4074
 Aus 14 x 14 mm
 1500 mm



Best.-Nr. 6174
 Aus 14 x 14 mm
 70 x 140 mm
gehämmert
martelé
hammered
martellato
dövmeli



Best.-Nr. 6074
 Aus 14 x 14 mm
 70 x 140 mm
glatt
lisse
plain
piatto
düz



Best.-Nr. 6077
 Aus 14 x 14 mm
 70 x 140 mm



Best.-Nr. 6076
 Aus 30 x 8 mm
 70 x 100 mm



Best.-Nr. 6175
 45 x 135 mm, Mat. 10 mm

Best.-Nr. 6176
 60 x 175 mm, Mat. 10 mm

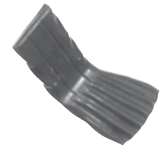

Best.-Nr. 6075
 Aus 40 x 8 mm, 70 x 100 mm
Gerillt / Rainure sur la tranche
Grooved / Scanalato / Yarmali

Best.-Nr. 6099
 Aus 40 x 8 mm, 70 x 100 mm
ohne Rillen / sans rainure
not grooved / Senza scanalatura
Düz

AK FER

Locheisen / Barreaux avec trous forgés
Bars with holes / Barre forate / Delikli traversler

ca. 2000 mm, 14 Loch/Stange / ca. 2000 mm, 14 Trous/Barre
 approx. 2000 mm, 14 Hole/Bar / circa 2000 mm, Barra forata con 14 fori / 14 delikli yaklaşık 2000 mm.lik çubuk

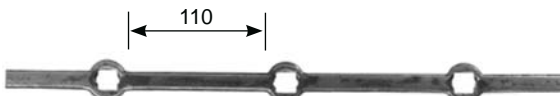

Best.-Nr. 11410-14 ■ 14 mm, Lochung □ 14 mm
Best.-Nr. 11410-20 ■ 20 mm, Lochung □ 20 mm

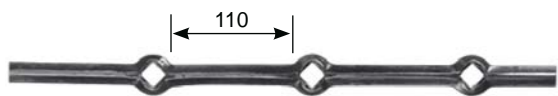

Best.-Nr. 11412-14 ◆ 14 mm, Lochung □ 14 mm
Best.-Nr. 11412-20 ◆ 20 mm, Lochung □ 20 mm

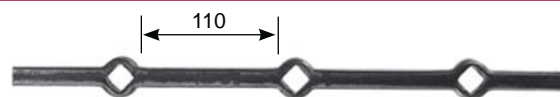

Best.-Nr. 11411-14 ■ 14 mm, Lochung □ 14 mm
Best.-Nr. 11411-20 ■ 20 mm, Lochung □ 20 mm



Best.-Nr. 11413-14 ● 14 mm, Lochung ○ 14 mm
Best.-Nr. 11413-20 ● 20 mm, Lochung ○ 20 mm



Best.-Nr.
9014
■ 24 mm
30 x 125 mm



Best.-Nr.
9011
Ø 30 mm
35 x 120 mm



Best.-Nr.
9025
Ø 20 mm
70 x 125 mm



Best.-Nr.
9005
60 x 125 mm

Ø 20 mm
Ø 13 mm



Best.-Nr.
9008
60 x 125 mm

Ø 20 mm
Ø 13 mm



Best.-Nr.
9029
50 x 150 mm



Best.-Nr.
9015
■ 32 mm
165 mm



Best.-Nr.
9012
Ø 33 mm
40 x 150 mm



Best.-Nr.
9026
Ø 25 mm
90 x 160 mm



Best.-Nr.
9006
70 x 160 mm

Ø 25 mm
Ø 17 mm



Best.-Nr.
9009
70 x 160 mm

Ø 25 mm
Ø 17 mm



Best.-Nr.
9028
60 x 175 mm



Best.-Nr.
9027
65 x 200 mm



Best.-Nr.
9020
Aus ø 12 mm

Best.-Nr.
9021
Aus 12 x 12 mm

Best.-Nr.
9022
Aus 12 x 12 mm
gehämmert
martelé
hammered
martellato
dövmeli
30 x 175 mm



Best.-Nr.
9016
Aus ø 12 mm

Best.-Nr.
9017
Aus 12 x 12 mm

Best.-Nr.
9023
Aus 12 x 12 mm
gehämmert
martelé
hammered
martellato
dövmeli
35 x 150 mm



Best.-Nr.
9001
Aus ø 12 mm

Best.-Nr.
9002
Aus 12 x 12 mm

Best.-Nr.
9003
Aus 12 x 12 mm
gehämmert
martelé
hammered
martellato
dövmeli
35 x 150 mm



Best.-Nr.
9018
Aus ø 12 mm

Best.-Nr.
9019
Aus 12 x 12 mm

Best.-Nr.
9024
Aus 12 x 12 mm
gehämmert
martelé
hammered
martellato
dövmeli
35 x 150 mm



Best.-Nr. **9301**
Ø 12 mm, 100 cm
Best.-Nr. **9302**
Ø 12 mm, 150 cm
Best.-Nr. **9303**
12 x 12 mm, 100 cm
Best.-Nr. **9304**
12 x 12 mm, 150 cm

Best.-Nr. **9305**
12 x 12 mm, 100 cm
gehämmert / martelé
hammered / martellato dövmeli

Best.-Nr. **9306**
12 x 12 mm, 150 cm
gehämmert / martelé
hammered / martellato dövmeli



Best.-Nr. **9307**
ø 12 mm, 100 cm
Best.-Nr. **9308**
ø 12 mm, 150 cm
Best.-Nr. **9309**
12 x 12 mm, 100 cm
Best.-Nr. **9310**
12 x 12 mm, 150 cm

Best.-Nr. **9323**
12 x 12 mm, 100 cm
gehämmert / martelé
hammered / martellato dövmeli

Best.-Nr. **9324**
12 x 12 mm, 150 mm
gehämmert / martelé
hammered / martellato dövmeli



Best.-Nr. **9311**
ø 12 mm, 100 cm
Best.-Nr. **9312**
ø 12 mm, 150 cm
Best.-Nr. **9313**
12 x 12 mm, 100 cm
Best.-Nr. **9314**
12 x 12 mm, 150 cm

Best.-Nr. **9315**
12 x 12 mm, 100 cm
gehämmert / martelé
hammered / martellato dövmeli

Best.-Nr. **9316**
12 x 12 mm, 150 mm
gehämmert / martelé
hammered / martellato dövmeli



Best.-Nr. **9317**
ø 12 mm, 100 cm
Best.-Nr. **9318**
ø 12 mm, 150 cm
Best.-Nr. **9319**
12 x 12 mm, 100 cm
Best.-Nr. **9320**
12 x 12 mm, 150 cm

Best.-Nr. **9321**
12 x 12 mm, 100 cm
gehämmert / martelé
hammered / martellato dövmeli

Best.-Nr. **9322**
12 x 12 mm, 150 cm
gehämmert / martelé
hammered / martellato dövmeli

AK FER

Rosetten / Rosettes forgées Forged rosettes / Rosette in ferro / Ferforje rozetler

65 x 65 mm, Material 4 mm	Best.-Nr.
ohne Loch	10809
mit Loch 12x12 mm	10810
mit Loch 16x16 mm	10811
mit Loch 20x20 mm	10812



ø 80 mm, Material 4 mm	Best.-Nr.
ohne Loch	10823
mit Loch 12x12 mm	10824
mit Loch 16x16 mm	10825
mit Loch 20x20 mm	10826
mit Loch 24x24 mm	10827



80x80 mm, Material 4 mm	Best.-Nr.
ohne Loch	10813
mit Loch 12x12 mm	10814
mit Loch 16x16 mm	10815
mit Loch 20x20 mm	10816
mit Loch 24x24 mm	10817



100 x 100 mm, Material 6 mm	Best.-Nr.
ohne Loch	10818

100 x 100 mm, Material 8 mm	Best.-Nr.
ohne Loch	10819

Best.-Nr. 10829 ø 65 mm Material 3 mm	Best.-Nr. 10828 ø 65 mm Material 3 mm	Best.-Nr. 10831 ø 130 mm Material 4 mm	Best.-Nr. 10830 ø 80 mm Material 2,5 mm
---	---	--	---

AK FER

Schmiedestücke & Zierteile / Accessoires en fer forgé Forgings & Accessories / Ferro battuto & Accessori / Dövme parçalar



Best.-Nr.
9202
rund



Best.-Nr.
9203
eckig



Best.-Nr.
9204



Best.-Nr.
9205



Best.-Nr.
6013
Aus 12 x 12 mm
glatt / lisse
plain / piatto / düz
Länge 290 mm



Best.-Nr.
6113
Aus 12 x 12 mm
gehämmert
martelé
hammered
martellato
dövmeli
Länge 290 mm



Best.-Nr.
6014
Aus 12 x 12 mm
glatt / lisse
plain / piatto / düz
55 x 100 mm



Best.-Nr.
6114
Aus 12 x 12 mm
gehämmert / martelé
hammered / martellato
dövmeli
55 x 100 mm



Best.-Nr. **9214**
Lochung ø 12,5 mm, ø 35 x 25 mm
Best.-Nr. **9215**
Lochung ø 14,5 mm, ø 35 x 25 mm



Best.-Nr.
9210
ø 40 x 90 mm



Best.-Nr. **9212**
Lochung ø 12,5 mm, ø 40 x 68 mm
Best.-Nr. **9213**
Lochung ø 14,5 mm, ø 40 x 68 mm



Best.-Nr. **9211**
Lochung
12,5 x 12,5 mm
40 x 40 x 70 mm

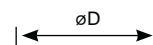

øD / mm	Gewicht / kg	Best.-Nr.
37	0,15	9206
45	0,50	9207
55	0,80	9208
65	1,40	9209

AK FER

Ringen / Anneaux / Rings / Anelli / Halkalar

Verschweisst und sauber verschliffen / Soudé et lissé / Welded and grinded / Saldati e lisciate / Kaynatılıp taşlanmış

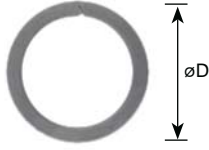

Material ● 12 mm

øD /mm	Best.-Nr.
100	6600
110	6601
120	6602

Material 12 x 12 mm

100	6610
110	6611
120	6612

Material 12 x 6 mm

100	6620
110	6621
120	6622

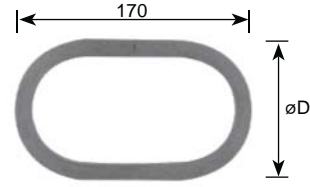

Material ● 12 mm

øD /mm	Best.-Nr.
100	6650
110	6651
120	6652

Material 12 x 12 mm

100	6660
110	6661
120	6662

Material 12 x 6 mm

100	6670
110	6671
120	6672

AK FER

Ornamente / Ornaments / Ornements / Oggetti ornamentali / Ornamentler

Material: 12 x 6 mm

Profiqualität!



Best.-Nr. 6017
240 x 240 mm

Best.-Nr. 6018
300 x 300 mm

Material: 12 x 6 mm

Profiqualität!



Best.-Nr. 6053
240 x 240 mm

Best.-Nr. 6054
300 x 300 mm



Best.-Nr.
6042
150 x 270 mm



Best.-Nr.
6043
120 x 210 mm



Best.-Nr.
6044
120 x 210 mm



Best.-Nr.
6045
100 x 120 mm



Best.-Nr.
6049
Zwirbel 20



Best.-Nr.
6048
Zwirbel 12

AK

FER

Ornamente / Ornaments / Ornaments / Oggetti ornamentali / Ornamentler

Ornament 650 x 450 mm



- Best.-Nr. **9400** aus \varnothing 12 mm, 3,50 kg
glatt / plain
lisse / piatto / düz
- Best.-Nr. **9401** aus 16 x 8 mm, 3,75 kg
gehämmert / martelé
hammered / martellato / dövme
- Best.-Nr. **9402** aus 16 x 8 mm, 3,75 kg
gerillt / rainure sur la tranche
grooved / scanalato / yarmalı

Ornament 710 x 710 mm



- Best.-Nr. **9410** aus \varnothing 12 mm, 3,25 kg
glatt / plain
lisse / piatto / düz
- Best.-Nr. **9411** aus 16 x 8 mm, 3,50 kg
gehämmert / martelé
hammered / martellato / dövme
- Best.-Nr. **9412** aus 16 x 8 mm, 3,50 kg
gerillt / rainure sur la tranche
grooved / scanalato / yarmalı

Ornament 615 x 775 mm



- Best.-Nr. **9406** aus \varnothing 12 mm, 6,20 kg
glatt / plain
lisse / piatto / düz
- Best.-Nr. **9407** aus 16 x 8 mm, 6,87 kg
gehämmert / martelé
hammered / martellato / dövme
- Best.-Nr. **9408** aus 16 x 8 mm, 6,87 kg
gerillt / rainure sur la tranche
grooved / scanalato / yarmalı

Ornament 500 x 450 mm



- Best.-Nr. **9403** aus 12 x 6 mm, 5,88 kg
glatt / plain
lisse / piatto / düz



Best.-Nr. **12007**
155 x 60 mm
Material 3 mm



Best.-Nr. **12008**
155 x 60 mm
Material 3 mm



Best.-Nr. **12035**
Rosenblatt
32 x 47 mm
Material 1 mm



Best.-Nr. **12009**
95 x 115 mm
Material 3 mm



Best.-Nr. **12010**
95 x 115 mm
Material 3 mm



Best.-Nr. **12003**
80 x 85 mm
Material 3 mm



Best.-Nr. **12004**
80 x 85 mm
Material 3 mm



Best.-Nr. **12005**
110 x 40 mm
Material 3 mm



Best.-Nr. **12006**
110 x 40 mm
Material 3 mm

Best.-Nr. **12036**
Länge ca.
340 mm

Best.-Nr. **12037**
Länge ca.
200 mm



Best.-Nr. **12029**
125 x 85 mm
Material 3 mm



Best.-Nr. **12031**
200 x 95 mm
Material 6 mm



Best.-Nr. **12032**
205 x 100 mm
Material 3 mm



Best.-Nr. **12033**
160 x 60 mm
Material 3 mm



Best.-Nr. **12013**
60 x 70 mm
Material 3 mm



Best.-Nr. **12012**
60 x 70 mm
Material 3 mm



Best.-Nr. **12038**
75 x 85 mm
Material 3 mm



Best.-Nr. **12017**
200 x 140 mm
Material 6 mm



Best.-Nr. **12018**
200 x 140 mm
Material 6 mm



Best.-Nr. **12019**
200 x 130 mm
Material 6 mm



Best.-Nr. **12020**
200 x 130 mm
Material 6 mm



Best.-Nr. **12039**
Weintraube
ca. 85 x 65 mm



Best.-Nr. **12040**
Weintraube
ca. 55 x 65 mm



Best.-Nr. **12030**
310 x 260 mm
Material 6 mm



Best.-Nr. **12027**
200 x 135 mm
Material 3 mm



Best.-Nr. **12028**
200 x 135 mm
Material 3 mm



Best.-Nr. **12024**
110 x 80 mm
Material 3 mm



Best.-Nr. **12025**
110 x 80 mm
Material 3 mm



Best.-Nr. **12014**
415 x 185 mm
Material 6 mm



Best.-Nr. **12015**
415 x 185 mm
Material 6 mm



Best.-Nr. **12041**
ca. 165x 110 mm



Best.-Nr. **12034**
Pfosten-Krone
90 x 170 mm



Best.-Nr. **12022**
210 x 135 mm
Material 6 mm



Best.-Nr. **12023**
210 x 135 mm
Material 6 mm

Neu
Novelty - New - Nispeten - Yeni

Stichbogen
Profil voué
Low profile vault
Lungo profilo leggermente arcuato
Kemer

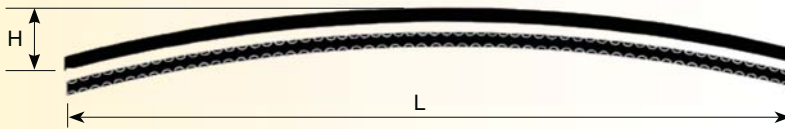

Glatt / Lisse / Plain / Piatto / Düz

L/mm	H/mm	Best.-Nr.	Material
4000 mm	200 mm	10042	30x30x2,5
4000 mm	200 mm	10043	40x20x2,5
4000 mm	200 mm	10044	40x30x2,5
4000 mm	200 mm	10045	40x40x2,5
4000 mm	200 mm	10046	50x30x2,5
4000 mm	200 mm	10047	60x40x2,5
3000 mm	200 mm	10005	30x30x2,5
3000 mm	200 mm	10050	40x20x2,5
3000 mm	200 mm	10051	40x30x2,5
3000 mm	200 mm	10004	40x40x2,5
3000 mm	200 mm	10052	50x30x2,5
3000 mm	200 mm	10006	60x40x2,5
2000 mm	200 mm	10055	30x30x2,5
2000 mm	200 mm	10056	40x20x2,5
2000 mm	200 mm	10057	40x30x2,5
2000 mm	200 mm	10058	40x40x2,5
2000 mm	200 mm	10059	50x30x2,5
2000 mm	200 mm	10060	60x40x2,5
1000 mm	150 mm	10023	30x30x2,5
1000 mm	150 mm	10063	40x20x2,5
1000 mm	150 mm	10064	40x30x2,5
1000 mm	150 mm	10003	40x40x2,5
1000 mm	150 mm	10065	50x30x2,5
1000 mm	150 mm	10066	60x40x2,5

Kantengehämmert / Martelé
 Hammered edges / Bordi martellati / Köşe dövmei

L/mm	H/mm	Best.-Nr.	Material
4000 mm	200 mm	10142	30x30x2,5
4000 mm	200 mm	10143	40x20x2,5
4000 mm	200 mm	10144	40x30x2,5
4000 mm	200 mm	10145	40x40x2,5
4000 mm	200 mm	10146	50x30x2,5
4000 mm	200 mm	10147	60x40x2,5
3000 mm	200 mm	10104	30x30x2,5
3000 mm	200 mm	10150	40x20x2,5
3000 mm	200 mm	10151	40x30x2,5
3000 mm	200 mm	10105	40x40x2,5
3000 mm	200 mm	10152	50x30x2,5
3000 mm	200 mm	10106	60x40x2,5
2000 mm	200 mm	10155	30x30x2,5
2000 mm	200 mm	10156	40x20x2,5
2000 mm	200 mm	10157	40x30x2,5
2000 mm	200 mm	10158	40x40x2,5
2000 mm	200 mm	10159	50x30x2,5
2000 mm	200 mm	10160	60x40x2,5
1000 mm	150 mm	10123	30x30x2,5
1000 mm	150 mm	10163	40x20x2,5
1000 mm	150 mm	10164	40x30x2,5
1000 mm	150 mm	10103	40x40x2,5
1000 mm	150 mm	10165	50x30x2,5
1000 mm	150 mm	10166	60x40x2,5

Geschweiffter Bogen
Profil voué avec extrémités horizontales
Low profile vault with horizontal edge
Lungo profilo leggermente arcuato, con estremi orizzontali
Uçları düz kemer



Glatt / Lisse / Plain / Piatto / Düz

L/mm	H/mm	Best.-Nr.	Material
4000 mm	200 mm	10072	30x30x2,5
4000 mm	200 mm	10073	40x20x2,5
4000 mm	200 mm	10074	40x30x2,5
4000 mm	200 mm	10075	40x40x2,5
4000 mm	200 mm	10076	50x30x2,5
4000 mm	200 mm	10077	60x40x2,5
3000 mm	200 mm	10010	30x30x2,5
3000 mm	200 mm	10080	40x20x2,5
3000 mm	200 mm	10081	40x30x2,5
3000 mm	200 mm	10011	40x40x2,5
3000 mm	200 mm	10082	50x30x2,5
3000 mm	200 mm	10012	60x40x2,5
2000 mm	200 mm	10085	30x30x2,5
2000 mm	200 mm	10086	40x20x2,5
2000 mm	200 mm	10087	40x30x2,5
2000 mm	200 mm	10088	40x40x2,5
2000 mm	200 mm	10089	50x30x2,5
2000 mm	200 mm	10090	60x40x2,5

Kantengehämmert / Martelé
 Hammered edges / Bordi martellati / Köşe dövmei

L/mm	H/mm	Best.-Nr.	Material
4000 mm	200 mm	10172	30x30x2,5
4000 mm	200 mm	10173	40x20x2,5
4000 mm	200 mm	10174	40x30x2,5
4000 mm	200 mm	10175	40x40x2,5
4000 mm	200 mm	10176	50x30x2,5
4000 mm	200 mm	10177	60x40x2,5
3000 mm	200 mm	10110	30x30x2,5
3000 mm	200 mm	10180	40x20x2,5
3000 mm	200 mm	10181	40x30x2,5
3000 mm	200 mm	10111	40x40x2,5
3000 mm	200 mm	10182	50x30x2,5
3000 mm	200 mm	10112	60x40x2,5
2000 mm	200 mm	10185	30x30x2,5
2000 mm	200 mm	10186	40x20x2,5
2000 mm	200 mm	10187	40x30x2,5
2000 mm	200 mm	10188	40x40x2,5
2000 mm	200 mm	10189	50x30x2,5
2000 mm	200 mm	10190	60x40x2,5

Rundbogen / Arc demi-cercle / Semi ring vault / Arco a semicerchio / Yarım daire kemer

Glatt / Lisse / Plain / Piatto / Düz

Länge	Best.-Nr.	Aus
900 mm	10001	30x30x2,5
900 mm	10022	40x20x2,5
900 mm	10024	40x30x2,5
900 mm	10025	40x40x2,5
900 mm	10026	50x30x2,5
900 mm	10027	60x40x2,5
1000 mm	10002	30x30x2,5
1000 mm	10030	40x20x2,5
1000 mm	10031	40x30x2,5
1000 mm	10032	40x40x2,5
1000 mm	10033	50x30x2,5
1000 mm	10034	60x40x2,5

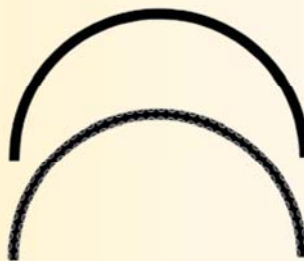

Sonderabmessungen auf anfrage
Dimensions spéciales sur demande
Special sizes of products on demand
Misure speciali su richiesta

Kantengehämmert / Martelé
 Hammered edges / Bordi martellati / Köşe dövmei

Länge	Best.-Nr.	Aus
900 mm	10101	30x30x2,5
900 mm	10122	40x20x2,5
900 mm	10124	40x30x2,5
900 mm	10125	40x40x2,5
900 mm	10126	50x30x2,5
900 mm	10127	60x40x2,5
1000 mm	10102	30x30x2,5
1000 mm	10130	40x20x2,5
1000 mm	10131	40x30x2,5
1000 mm	10132	40x40x2,5
1000 mm	10133	50x30x2,5
1000 mm	10134	60x40x2,5

AK FER

Schmiedeeisen-Drückergarnituren / Poignées en fer forgé
Wrought iron handles / Maniglie in ferro battuto / Ferforje kapı kolları

Oberfläche
galvanisch verzinkt
lackiert
gebürstet
transparent pulverbeschichtet

Surface
galvanisé
laqué
brossee
revêtement par poudre

Surface
zinc plated
lacquered
brushed
powder coated

Superficie
zincato
laccato
spazzolato
verniciato a polvere

Yüzey
elektro galvanizli
boyalı
firçalı
toz boyalı

passend auf Best-Nr 10201

123
4567
890
abcd

Best.-Nr./Code
10632



Ø 50 mm
Best.-Nr.
10629-FU



Ø 50 mm
Best.-Nr.
10629-PZ

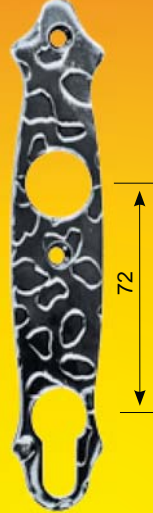

30 x 160 mm
Best.-Nr. 10622

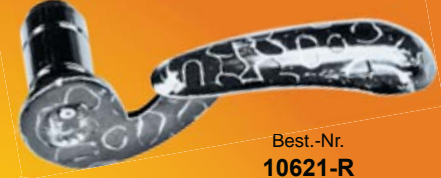

Best.-Nr.
10621-R



Best.-Nr.
10621-L

New - Nuovo - Yeni
Neu



Best.-Nr.
10625-F
Knopf
fest/ fix

Best.-Nr.
10625-D
Knopf
drehbar/ non-fix



Best.-Nr.
10623-R



Best.-Nr.
10628
Knopf
drehbar/ non-fix



Best.-Nr.
10623-L

Seite / Page / Page / Pagina / Sayfa 87



Beispiele möglicher Kombinationen / Exemples de combinaisons possibles
Possible combination examples / Possibile combinazione di esempi / Olası kombinasyon örnekleri

Typ 1, 2, 3

Typ 4, 5

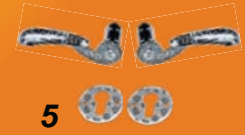

Schmiedeeisen-Schlossblenden / Plaques de serrure en fer forgé

Wrought iron lock plates / Placche per serratura in ferro battuto / Ferforje aynalar

E = 72 mm, A = 60 mm

E = 72 mm, A = 40 mm

E = 72 mm, A = 60 mm

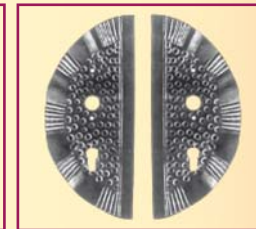
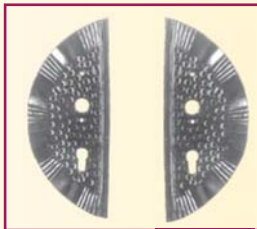
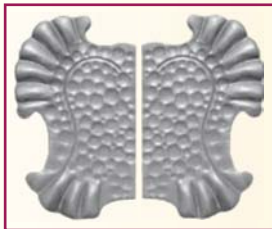
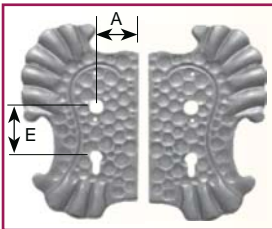

Best.-Nr.
10407
275x160 mm
0,72 kg

Best.-Nr.
10408
275x160 mm
0,72 kg

Best.-Nr.
10409
275x160 mm
0,75 kg

Best.-Nr.
10410
275x160 mm
0,75 kg

Best.-Nr.
10401
120x290 mm
0,61 kg

Best.-Nr.
10402
120x290 mm
0,61 kg

Best.-Nr.
10403
120x290 mm
0,64 kg

Best.-Nr.
10404
130x290 mm
0,67 kg

Best.-Nr.
10405
130x290 mm
0,67 kg

Best.-Nr.
10406
130x290 mm
0,70 kg

E-mail: bilgi@yapimetal.net, www.yapimetal.net

Telefon: (312) 385 48 06 - Belgegeçer: (312) 385 42 16

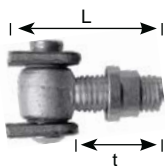

Für/ for/ pour	L x t	Best.-Nr.
M18	75 x 40	10513
M22	85 x 46	10514



Für/ for/ pour	Best.-Nr.
M18	10519
M22	10520

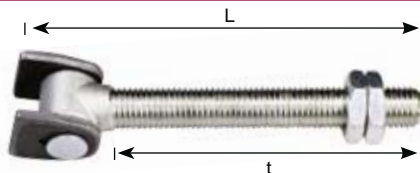

Für/ for/ pour	L x t	Best.-Nr.
M20	175 x 142	10517
M24	186 x 155	10518



øD /mm	L /mm	Best.-Nr.
30	150	10501
24	120	10502
20	100	10503



øD /mm	L /mm	Best.-Nr.
30	150	10505
24	120	10506
20	100	10507



øD /mm	L /mm	Best.-Nr.
30	150	10510



øD /mm	Kegel ø/mm	Für/ for/ pour	Best.-Nr.
24	14	M20	10511
30	20	M22	10512



3-teilig mit
Anschweißhülse
Auf Wunsch mit Mauerhülse
erhältlich!

øD /mm	Kegel ø/mm	Für/ for/ pour	Best.-Nr.
24	14	M20	10508
30	20	M22	10509

Torriegel für Hängeschloss / Verrou au sol pour porte
Door bolt / Chiavistello / Kapı Sürgüsü

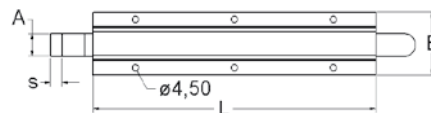

L /mm	B /mm	A /mm	s /mm	Best.-Nr.
200	55	25	8	10740-200

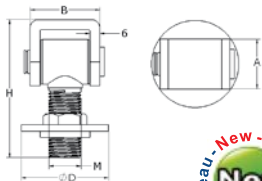

M	øD /mm	H /mm	A /mm	B /mm	Best.-Nr.
M16	53	79,5	30	43	10521-16
M20	66	85,0	30	43	10521-20
M24	65	101	35	49	10521-24

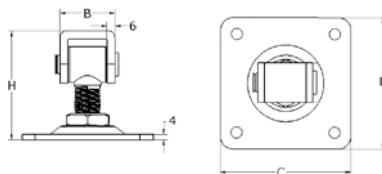

M	H /mm	B /mm	L /mm	C /mm	Best.-Nr.
M16	62-83	43,0	79	79	10523-16
M20	62-90	43,0	100	100	10523-20
M24	68-100	49,3	120	120	10523-24

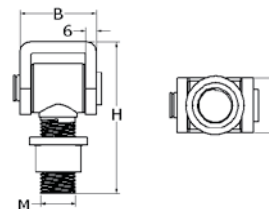

M	H /mm	B /mm	A /mm	Best.-Nr.
M16	78,5	42	30	10522-16
M20	86,0	42	30	10522-20
M24	100,5	46	35	10522-24

AK FER

Schiebetorrollen / Galets / Wheels / Ruote / Makaralar

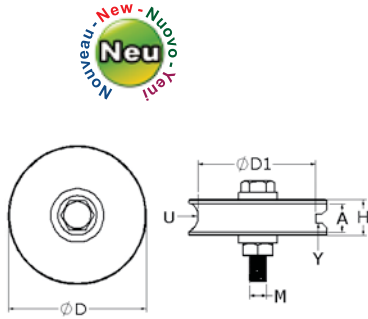

New - Nuovo - Yeni
Neu

Y - Rille / Gorge Y / Y-Groove / Scanalatura a Y / Y-yiv					
øD /mm	H /mm	øD1 /mm	A /mm	M /mm	Best.-Nr.
58	17	44,6	13,6	10	10712-60Y
68	20	51,6	16,0	10	10712-70Y
78	20	61,6	16,5	10	10712-80Y

U - Rille / Gorge U / U-Groove / Scanalatura a U / U-yiv					
øD /mm	H /mm	øD1 /mm	A /mm	M /mm	Best.-Nr.
58	17	49	13,6	10	10712-60U
68	20	57	16,0	10	10712-70U
78	20	68	16,5	10	10712-80U



New - Nuovo - Yeni
Neu

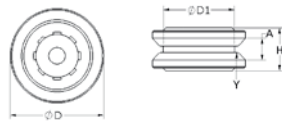

Schiebetorrolle mit 2 Kugellagern
Galet à 2 roulements / Wheel with 2 bearings
Ruota con doppio sostegno
Çift rulmanlı tekerlek silindiri

V - Rille / Gorge V / V-Groove / Scanalatura a V / V-yiv				
øD /mm	øD1 /mm	H /mm	A /mm	Best.-Nr.
58	43,00	31	15	10709-60V
68	51,70	31	16	10709-70V
78	61,00	30	17	10709-80V

Schiebetorrolle mit 2 Kugellagern / Galet à 2 roulements
Wheel with 2 bearings / Ruota con doppio sostegno
Çift rulmanlı tekerlek silindiri

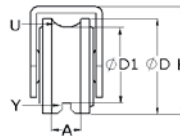

New - Nuovo - Yeni
Neu



V - Rille / Gorge V / V-Groove / Scanalatura a V / V-yiv						
øD /mm	øD1 /mm	H /mm	A /mm	B /mm	C /mm	Best.-Nr.
58	44,6	65	16	44,0	48	10708-60V
68	51,6	79	16	44,5	80	10708-70V
78	61,6	84	16	44,5	80	10708-80V



New - Nuovo - Yeni
Neu

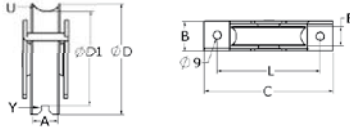

Y - Rille / Gorge Y / Y-Groove / Scanalatura a Y / Y-yiv							
øD /mm	øD1 /mm	A /mm	B /mm	C /mm	E /mm	L /mm	Best.-Nr.
78	61,6	15,5	32	136	20	112,0	10711-80Y
88	70,4	16,0	32	152	21	128,5	10711-90Y
98	79,5	16,5	32	152	22	128,5	10711-100Y

U - Rille / Gorge U / U-Groove / Scanalatura a U / U-yiv							
øD /mm	øD1 /mm	A /mm	B /mm	C /mm	E /mm	L /mm	Best.-Nr.
78	68,0	15,5	32	136	20	112,0	10711-80U
88	77,0	16,0	32	152	21	128,5	10711-90U
98	86,4	16,5	32	152	22	128,5	10711-100U



New - Nuovo - Yeni
Neu

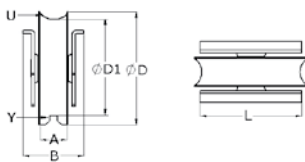

Y - Rille / Gorge Y / Y-Groove / Scanalatura a Y / Y-yiv					
øD /mm	øD1 /mm	A /mm	B /mm	L /mm	Best.-Nr.
58	44,6	14,0	39	59	10713-60Y
68	51,6	16,5	39	59	10713-70Y
78	61,6	15,5	41	71	10713-80Y

U - Rille / Gorge U / U-Groove / Scanalatura a U / U-yiv					
øD /mm	øD1 /mm	A /mm	B /mm	L /mm	Best.-Nr.
58	49	14,0	39	59	10713-60U
68	57	16,5	39	59	10713-70U
78	68	15,5	41	71	10713-80U



New - Nuovo - Yeni
Neu

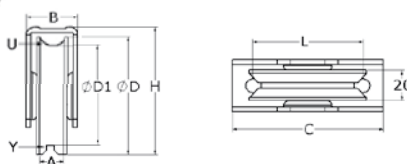

Y - Rille / Gorge Y / Y-Groove / Scanalatura a Y / Y-yiv							
øD /mm	øD1 /mm	H /mm	A /mm	B /mm	C /mm	L /mm	Best.-Nr.
58	44,6	63,80	13,3	27,65	85	55	10710-60Y
68	51,6	79,00	15,3	34,25	100	70	10710-70Y
78	61,6	84,65	15,6	34,40	100	70	10710-80Y
98	79,5	106,00	16,5	36,00	132	105	10710-100Y

U - Rille / Gorge U / U-Groove / Scanalatura a U / U-yiv							
øD /mm	øD1 /mm	H /mm	A /mm	B /mm	C /mm	L /mm	Best.-Nr.
58	49,0	63,80	13,3	27,65	85	55	10710-60U
68	57,0	79,00	15,3	34,25	100	70	10710-70U
78	68,0	84,65	15,6	34,40	100	70	10710-80U
98	86,4	106,00	16,5	36,00	132	105	10710-100U

AK FER

Torführungsbügel / Platinas guides-portails
Drive-gate plates / Piastrre guida per cancelli / Sürgülü kapı plakaları



Neu
 Nouveau - New - Nuovo - Yeni

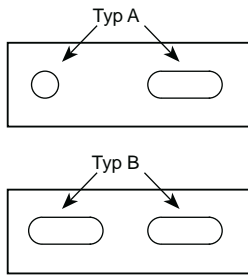
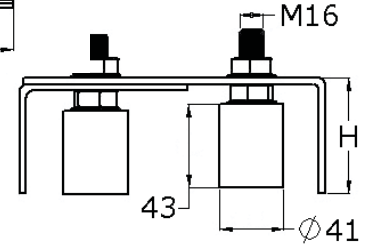
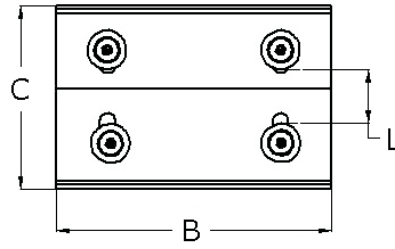

Best.-Nr.	Typ A	Typ B	B /mm	C /mm	L /mm	H /mm	Roller /mm
10724-220-1	X		220	150-210	20-65	55	Ø41 x 43
10724-220-1		X	220	135-180	30-75	55	Ø41 x 43
10724-220-2	X		220	115-180	15-65	55	Ø31 x 43
10724-220-2		X	220	135-180	30-75	55	Ø31 x 43
10725-290	X		290	170-260	55-100	65	Ø41 x 43
10725-290		X	290	170-260	20-100	65	Ø41 x 43
10725-350	X		350	170-260	55-100	65	Ø41 x 43
10725-350		X	350	170-260	20-100	65	Ø41 x 43



Neu
 Nouveau - New - Nuovo - Yeni

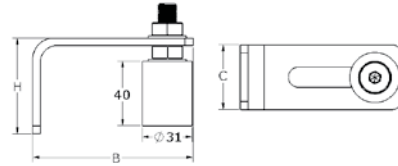
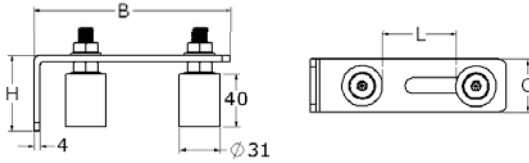

Best.-Nr.	B /mm	L /mm	H /mm	C /mm	Roller /mm
10727-25	150	20-65	55	40	Ø25 x 40
10727-31	150	11-60	55	40	Ø31 x 40

Best.-Nr.	B /mm	H /mm	C /mm	Roller /mm
10726-25	100	60	40	Ø25 x 40
10726-31	100	60	40	Ø31 x 40



Neu
 Nouveau - New - Nuovo - Yeni

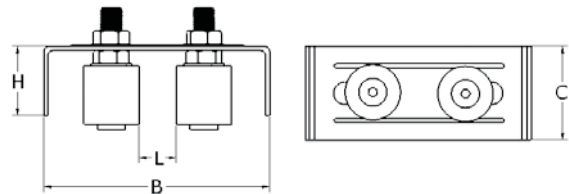

Best.-Nr.	B /mm	L /mm	H /mm	Roller /mm
10723-70	165	30-70	65	Ø41 x 43

AK FER

Türstopper / Butée pour portail coulissant
Stop for sliding gate / Fermo per cancelli scorrevoli / Kapı durdurucuları

Neu
 Nouveau - New - Nuovo - Yeni

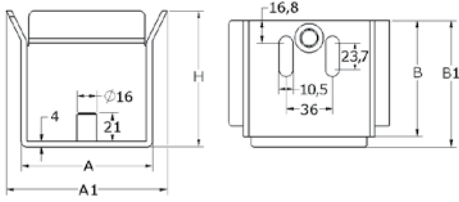

H /mm	A /mm	A1 /mm	B /mm	B1 /mm	Best.-Nr.
98,5	102	137	98	118	10721-100

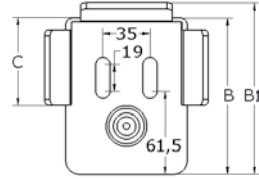
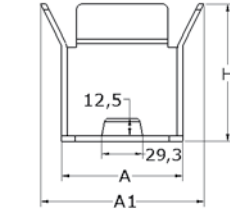

H /mm	A /mm	A1 /mm	B /mm	B1 /mm	Best.-Nr.
80	125	100	65	140	10722-65
80	125	115	85	140	10722-85
105	165	125	100	180	10722-100



Neu
 Nouveau - New - Nuovo - Yeni

Oberfläche
 Feuerverzinkt
Surface galvanisé
Surface zinc plated
Superficie zincato
Yüzey galvanizli



A /mm	Best.-Nr.
33	10701
43	10702
-	10705

Best.-Nr./Code **10705**
 ohne riegelsschlitz / butoir sans fente
 without slot / senza fessura / deliksiz

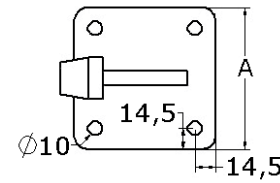
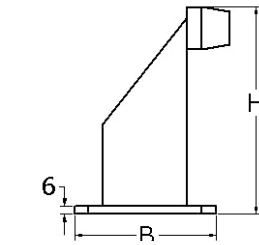

Ax Bx H /mm	Best.-Nr.
100 x 100 x 140	10729



Neu
 Nouveau - New - Nuovo - Yeni

AK FER

Nylon-Führungsrolle / Cylindre-guidant en nylon
Nylon roller / Cilindri in nylon / Nylon silindir



Neu
 Nouveau - New - Nuovo - Yeni

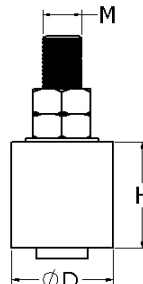

øD x H /mm	M	Best.-Nr.
41 x 43	16	10720-4140B

øD x H /mm	M	Best.-Nr.
25 x 40	12	10720-2540W
31 x 40	12	10720-3140W
41 x 43	16	10720-4140W



Schlossgehäuse, Links oder rechts verwendbar, 2-tourig
Boîtier en inox, Disponible droite et gauche, à 2 tours.
Lock case, Left or right side usage with 2-tours lock.
Serratura, Utilizzabile sia a destra che a sinistra, scrocco a doppio giro.
Kilit Kasası, Sağ ve Sol olarak kullanılabilir, iki türlü kilit ile.

T x H x B /mm	Best.-Nr.
96 x 172 x 30	10201-30
96 x 172 x 34	10201-34
96 x 172 x 40	10201-40
96 x 172 x 50	10201-50

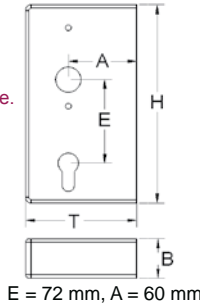

Schlossgehäuse mit Doppelsylinder,
Links oder rechts verwendbar
Boîtier en inox, Disponible droite et gauche, à 2 tours.
Lock case, Left or right side usage with 2-tours lock.
Serratura, Utilizzabile sia a destra che a sinistra, scrocco a doppio giro.
Kilit Kasası, Sağ ve Sol olarak kullanılabilir, iki türlü kilit ile.

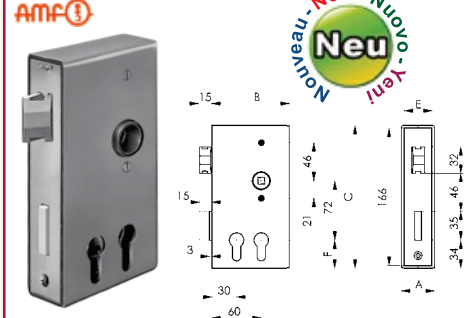

T x H x B /mm	Best.-Nr.
96 x 172 x 30	10201-30-D
96 x 172 x 34	10201-34-D
96 x 172 x 40	10201-40-D
96 x 172 x 50	10201-50-D



Schmales Schlossgehäuse,
Links oder rechts verwendbar, 1-tourig
Boîtier de serrure étroit,
Utilisable droite et gauche, serrure à un tour
Narrow lock case,
Left or right side usage with 1-tour lock
Serratura stretta,
Utilizzo a destra o sinistra, serratura a giro singolo
Dar kilit kasası
Sağ ve sol olarak kullanılabilir, bir türlü kilit ile

T x H x B /mm	Best.-Nr.
65 x 172 x 30	10230
65 x 172 x 40	10230-40

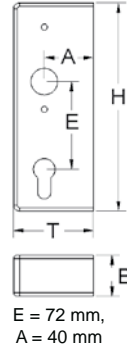

Schlossgehäuse mit Hakenfalle
Boîtier de serrure à crochet pour porte coulissante
Lock case for sliding doors with hook
Serratura per porta scorrevole, ad uncino
Kilit kasası kancalı kilit ile

T x H x B /mm	Best.-Nr.
96 x 172 x 30	10250-30
96 x 172 x 34	10250-34
96 x 172 x 40	10250-40
96 x 172 x 50	10250-50

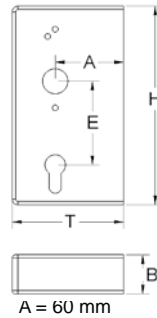

Schlossgehäuse mit Hakenfalle und Doppelsylinder
Boîtier de serrure à crochet pour porte coulissante
Lock case for sliding doors with hook
Serratura per porta scorrevole, ad uncino
Kilit kasası kancalı kilit ile

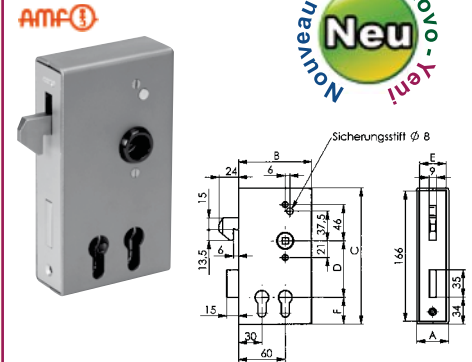

T x H x B /mm	Best.-Nr.
96 x 172 x 30	10250-30-D
96 x 172 x 34	10250-34-D
96 x 172 x 40	10250-40-D
96 x 172 x 50	10250-50-D



Gegenkasten, Gehäuse und Schliessblech
Gâche, Boîtier et platine de gâche
Striking case, Lock case and striking plate
Controbocchetta, Serratura e controbocchetta
Karşılık kasası, Kasa ve ayna

T x H x B /mm	Best.-Nr.
96 x 172 x 30	10221-30
96 x 172 x 34	10221-34
96 x 172 x 40	10221-40
96 x 172 x 50	10221-50

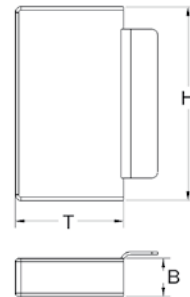

T x H x B /mm	Best.-Nr.
45 x 172 x 30	10210-30
45 x 172 x 34	10210-34
45 x 172 x 40	10210-40
45 x 172 x 50	10210-50

Schliesskasten zum Einbetonieren,
Gehäuse und Schliessblech
Gâche à encastrer pour béton,
Boîtier et platine de gâche
Striking box to set in concrete,
Lock case and striking plate
Scatola di chiusura per serratura per porta scorrevole, ad incastro,
Serratura e controbocchetta
Karşılık kasası betonlama çatalları ile
Kasa ve ayna

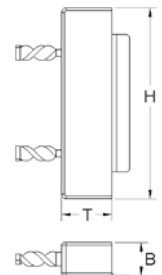

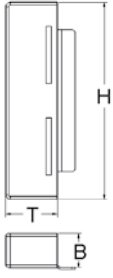

B x H = 96 mm x 172 mm

T x H x B /mm	Best.-Nr. DIN Rechts
45x172x30	10221-30-E
45x172x34	10221-34-E
45x172x40	10221-40-E
45x172x50	10221-50-E

Gegenkasten vorgerichtet für e-Öffner
Gâche avec fente pour ouverture de porte électrique
Striking box with slot for electric door opener
Controbocchetta per serratura elettrica
Elektrikli kapı otomatığı için karşılık kasası

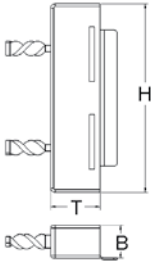

T x H x B /mm	Best.-Nr. DIN Rechts
45x172x30	10210-30-E
45x172x34	10210-34-E
45x172x40	10210-40-E
45x172x50	10210-50-E

Gegenkasten vorgerichtet für e-Öffner
Gâche avec fente pour ouverture de porte électrique
Striking box with slot for electric door opener
Controbocchetta per serratura elettrica
Elektrikli kapı otomatığı için karşılık kasası

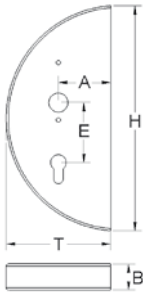

E = 72 mm, A = 60 mm

T x H x B /mm	Best.-Nr.
130 x 250 x 30	10203-30
130 x 250 x 34	10203-34
130 x 250 x 40	10203-40
130 x 250 x 50	10203-50

Design-Schlossgehäuse,
Links oder rechts verwendbar, 2-tourig
Boîtier de serrure design ,
Disponible droite et gauche, à 2 tours.
Design lock case,
Left or right side usage with 2-tours lock.
Serratura design,
Utilizzabile sia a destra che a sinistra, scrocco
a doppio giro.
Dizayn kilit kasası,
Sağ ve Sol olarak kullanılabilir, iki türlü kilit ile.



T x H x B /mm	Best.-Nr.
130 x 250 x 30	10223-30
130 x 250 x 34	10223-34
130 x 250 x 40	10223-40
130 x 250 x 50	10223-50

Design-Gegenkasten,
Links oder rechts verwendbar
Gâche design ,
Utilisable droite et gauche
Design striking case,
Left or right side usage
Controbocchetta design,
Utilizzo a sinistra o a destra
Dizayn karşılık kasası,
Sağ ve sol olarak kullanılabilir

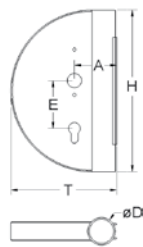

Anschluss "rund"
Fixation pour barreau
"Round" connection
Attacco speciale per incastro su tubi
Boruya montaj için

øD in mm	T x H /mm	Best.-Nr.
42,4	130 x 250	10202-42
48,3	130 x 250	10202-48

Design-Schlossgehäuse,
Links oder rechts verwendbar, 2-tourig
Boîtier de serrure design ,
Disponible droite et gauche, à 2 tours.
Design lock case,
Left or right side usage with 2-tours lock.
Serratura design,
Utilizzabile sia a destra che a sinistra, scrocco
a doppio giro.
Dizayn kilit kasası,
Sağ ve Sol olarak kullanılabilir, iki türlü kilit ile.

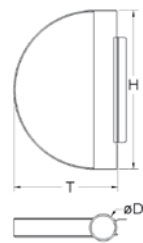

Anschluss "rund"
Fixation pour barreau
"Round" connection
Attacco speciale per incastro su tubi
Boruya montaj için

øD /mm	T x H /mm	Best.-Nr.
42,4	130 x 250	10222-42
48,3	130 x 250	10222-48

Design-Gegenkasten,
Links oder rechts verwendbar
Gâche design ,
Utilisable droite et gauche
Design striking case,
Left or right side usage
Controbocchetta design,
Utilizzo a sinistra o a destra
Dizayn karşılık kasası,
Sağ ve sol olarak kullanılabilir



AK FER

Schloss & Zubehör / Serrures & Accessoires
Locks & Accessories / Serrature e Accessori / Kilitler & Aksesuarları



Einsteckschloss – Lose
Serrure à encastrer
Mortise Lock
Serratura a incastro
Gömme kilit

Für/ for/ pour	Best.-Nr.
10230	10230-L
10230-40	10230-40-L
10200-30	10200-30-L
10200-34	10200-34-L
10200-40	10200-40-L
10200-50	10200-50-L



Einsteckschloss mit Hakenfalle – Lose
Serrure à encastrer à crochet
Mortise lock for sliding doors with hook
Serratura a scrochetto per porta scorrevole
Sürgülü kapılar için kancalı gömme kilidi

Für/for/pour	Best.-Nr.
10250-30	10250-30-L
10250-34	10250-34-L
10250-40	10250-40-L
10250-50	10250-50-L

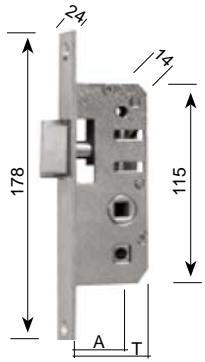

Rohrrahmenschloss, verzinkt.
Serrure pour profils tubulaires, galvanisée.
Tubular frame lock, galvanised.
Serratura, zincata
Gömme kilit, galvanizli

T /mm	A /mm	Best.-Nr.
30,5	18	10235-18
36,5	24	10235-24
41,5	30	10235-30
46,5	35	10235-35
51,5	40	10235-40

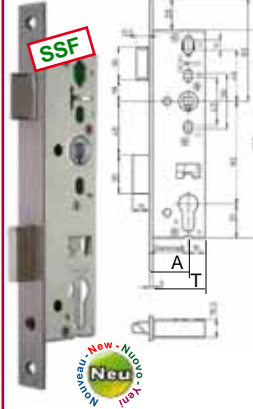

Rohrrahmenschloss, verzinkt. 1-tourig
Serrure pour profils tubulaires, galvanisée.
1 tour
Tubular frame lock, galvanised. 1-tour
Serratura, zincata. A giro unico
Gömme kilit, galvanizli. Tek tur

T /mm	A /mm	Best.-Nr.
30,5	18	10233-18
36,5	24	10233-24
41,5	30	10233-30
46,5	35	10233-35
51,5	40	10233-40

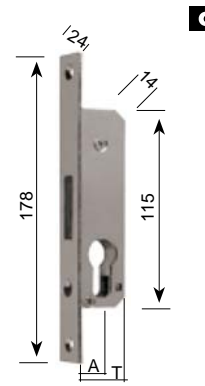

Rohrrahmenschloss, verzinkt. 1-tourig
Serrure pour profils tubulaires, galvanisée. 1 tour
Tubular frame lock, galvanised. 1-tour
Serratura, zincata. A giro unico
Gömme kilit, galvanizli. Tek tur

T /mm	A /mm	Best.-Nr.
30,5	18	10232-18
36,5	24	10232-24
41,5	30	10232-30
46,5	35	10232-35
51,5	40	10232-40



Elektrischer Türöffner mit Entriegelung,
Links oder Rechts verwendbar
Gâche électrique avec levier de déblocage.,
Utilisable droite et gauche
Electric door opener with mechanical release.,
Left or right side usage
Apertura elettrica con meccanismo a rilascio
meccanico,
Utilizzo a sinistra o a destra
Elektrikli kapı açma otomatığı,
Sağ ve sol olarak kullanılabilir

6-12V AC/DC,
67 x 16,5 x 28,5 mm

Best.-Nr. 10270

AK FER

Schliessbleche / Platines de gâche
Striking plates / Controbocchette / Kilit aynaları

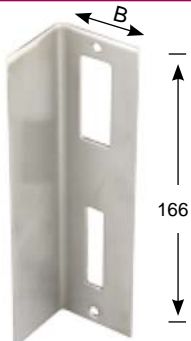

B = 30, 34, 40 mm
Best.-Nr. 10212-B



B = ø 33,7 / 42,4 / 48,3 mm
Best.-Nr. 10213-B



B = 24, 28, 34 mm
Best.-Nr. 10211-B



B = 24, 28, 34 mm
Best.-Nr. 10211E-B

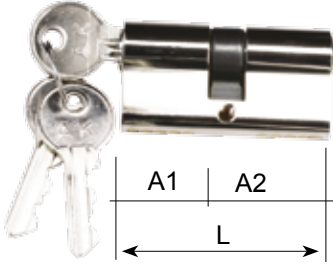

"ecoline"

verschiedenschließend / système de clés multiples
different keying / sistema di chiavi multiple / farklı kilitleme

A1-A2 /mm	L /mm	Best.-Nr.
10-30	40	10240-1030
21-21	42	10240-2121
25-25	50	10240-2525
28-28	56	10240-2828
30-30	60	10240-3030
30-35	65	10240-3035
30-40	70	10240-3040
35-35	70	10240-3535
35-40	75	10240-3540
40-40	80	10240-4040

gleichschließend / serrures avec clés communes
cylinders with common keys / cilindri con chiavi comuni
Ortak anahtarlı silindirler

A1-A2 /mm	L /mm	Best.-Nr.
10-30	40	10240-1030-G
21-21	42	10240-2121-G
25-25	50	10240-2525-G
28-28	56	10240-2828-G
30-30	60	10240-3030-G
30-35	65	10240-3035-G
30-40	70	10240-3040-G
35-35	70	10240-3535-G
35-40	75	10240-3540-G
40-40	80	10240-4040-G

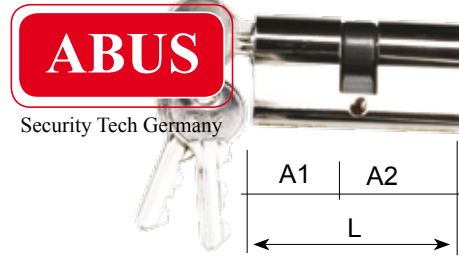

Security Tech Germany

verschiedenschließend / système de clés multiples
different keying / sistema di chiavi multiple / farklı kilitleme

A1-A2 /mm	L /mm	Best.-Nr.
10-30	40	10241-1030
21-21	42	10241-2121
25-25	50	10241-2525
28-28	56	10241-2828
30-30	60	10241-3030
30-35	65	10241-3035
30-40	70	10241-3040
35-35	70	10241-3535
35-40	75	10241-3540
40-40	80	10241-4040

gleichschließend / serrures avec clés communes
cylinders with common keys / cilindri con chiavi comuni
Ortak anahtarlı silindirler

A1-A2 /mm	L /mm	Best.-Nr.
10-30	40	10241-1030-G
21-21	42	10241-2121-G
25-25	50	10241-2525-G
28-28	56	10241-2828-G
30-30	60	10241-3030-G
30-35	65	10241-3035-G
30-40	70	10241-3040-G
35-35	70	10241-3535-G
35-40	75	10241-3540-G
40-40	80	10241-4040-G



A-Wechselstift, min M6-Gewinde
Rectangle, embout fileté M6
Spindle, with M6-thread and slotted edge
Adattatore con filetto M6 ad un'estremità
Yanklı ve M6 diş uçlu kol pimi

A x L /mm	Best.-Nr.	Paket/Stk./ pcs.
8 x 80	B-8a/8x80	10
8 x 85	B-8a/8x85	10
8 x 95	B-8a/8x95	10
8 x 105	B-8a/8x105	10
8 x 115	B-8a/8x115	10

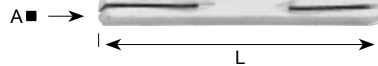

A-Vollstift, beidseitig gekerbt
Rectangle, fendu aux deux extrémités
Spindle, slotted at both edges
Adattatore, con fessure alle estremità
Uçları yarıklı kol pimi

A x L /mm	Best.-Nr.	Paket/Stk./ pcs.
8 x 80	B-ZH9a/8x80	10
8 x 100	B-ZH9a/8x100	10
8 x 130	B-ZH9a/8x130	10



Reduzierhülse
Manchon adaptateur
Spindle adapter
Adattatore
Kol pimi adaptörü

Abmessung /mm	Best.-Nr.	Paket/Stk./ pcs.
9 auf/to/en 8	B-ZH25/9-8	10
10 auf/to/en 8	B-ZH25/10-8	10