



Rohrabschlussstopfen, gewölbt
Embout de fermeture, Bombé
End cap, Cambered
Coperchio, Bombato
Boru kapağı, Bombeli

øD x s /mm	Best.-Nr.
26,9 x 2,0	1004
33,7 x 2,0	1001
33,7 x 2,6	1005
42,4 x 2,0	1002
42,4 x 2,6	1006
48,3 x 2,0	1003
48,3 x 2,6	1007
60,3 x 2,0	1008



Rohrabschlussstopfen, gewölbt mit M8 Gewinde
Embout de fermeture, Bombé avec filetage M8
End cap, Cambered with M8-thread
Coperchio, Coperchio bombato con foro filettato M8
Boru kapağı, Bombeli M8-Dişli

øD x s /mm	Best.-Nr.
26,9 x 2,0	1004-G
33,7 x 2,0	1001-G
33,7 x 2,6	1005-G
42,4 x 2,0	1002-G
42,4 x 2,6	1006-G
48,3 x 2,0	1003-G
48,3 x 2,6	1007-G
60,3 x 2,0	1008-G



Rohrabschlussstopfen, flach
Embout de fermeture, Plat
End cap, Flat
Coperchio, Piatto
Boru kapağı, Düz

øD x s /mm	Best.-Nr.
26,9 x 2,0	1013
33,7 x 2,0	1010
33,7 x 2,6	1014
42,4 x 2,0	1011
42,4 x 2,6	1015
48,3 x 2,0	1012
48,3 x 2,6	1016
60,3 x 2,0	1017



Rohrabschlussstopfen, flach mit M8 Gewinde
Embout de fermeture, Plat, filetage M8
End cap, Flat, with M8-thread
Coperchio, Piatto, con foro filettato M8
Boru kapağı, Düz M8-Dişli

øD x s /mm	Best.-Nr.
26,9 x 2,0	1013-G
33,7 x 2,0	1010-G
33,7 x 2,6	1014-G
42,4 x 2,0	1011-G
42,4 x 2,6	1015-G
48,3 x 2,0	1012-G
48,3 x 2,6	1016-G
60,3 x 2,0	1017-G



Rohr-Kugelstopfen
Embout hémisphérique
Hemisphere end cap
Coperchio semisferico
Yarım küre boru kapağı

øD x s /mm	Best.-Nr.
26,9 x 2,0	1023
33,7 x 2,0	1020
33,7 x 2,6	1024
42,4 x 2,0	1021
42,4 x 2,6	1025
48,3 x 2,0	1022
48,3 x 2,6	1026



Rohr-Kugelstopfen, mit M8 Gewinde
Embout hémisphérique, Filetage M8
Hemisphere end cap, With M8- thread
Coperchio semisferico, Con foro filettato M8
Yarım küre boru kapağı, M8-Dişli

øD x s /mm	Best.-Nr.
26,9 x 2,0	1023-G
33,7 x 2,0	1020-G
33,7 x 2,6	1024-G
42,4 x 2,0	1021-G
42,4 x 2,6	1025-G
48,3 x 2,0	1022-G
48,3 x 2,6	1026-G

Top

V2A / INOX 304



Rohrabschlussstopfen, gewölbt mit 8 mm Bohrung
Embout de fermeture, Bombé avec trou de 8 mm
End cap, Cambered with 8 mm hole
Coperchio, Bombato con foro da 8mm
Boru kapağı, Bombeli 8 mm delikli

øD x s /mm	Best.-Nr.
26,9 x 2,0	1004-B
33,7 x 2,0	1001-B
33,7 x 2,6	1005-B
42,4 x 2,0	1002-B
42,4 x 2,6	1006-B
48,3 x 2,0	1003-B
48,3 x 2,6	1007-B
60,3 x 2,0	1008-B

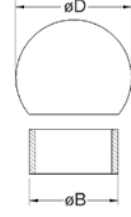

Rohr-Abschlusskugeln
Embout sphérique / Sphere end cap
Coperchio a sfera / Küre boru kapağı

øB /mm	øD /mm	Best.-Nr.
26,9	40	1050
33,7	45	1051
42,4	55	1052
48,3	60	1053

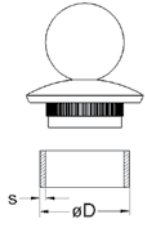

Rohr-Knopf
Pommeaux / Knobs / Pomoli / Topuz

øD x s /mm	Best.-Nr.
33,7 x 2,0	1036
33,7 x 2,6	1037
42,4 x 2,0	1038
42,4 x 2,6	1039
48,3 x 2,0	1040
48,3 x 2,6	1041

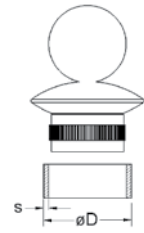
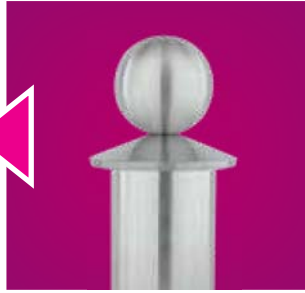

Rohr-Knopf
Pommeaux / Knobs / Pomoli / Topuz

øD x s /mm	Best.-Nr.
33,7 x 2,0	1030
33,7 x 2,6	1033
42,4 x 2,0	1031
42,4 x 2,6	1034
48,3 x 2,0	1032
48,3 x 2,6	1035

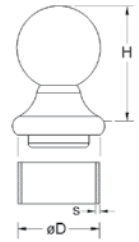

Rohr-Knopf
Pommeaux / Knobs / Pomoli / Topuz

øD x s /mm	H /mm	Best.-Nr.
32,0 x 1,5	42	1042-32E
33,7 x 2,0	42	1042-33
38,0 x 1,5	53	1042-38E
42,4 x 1,5	53	1042-42E
42,4 x 2,0	53	1042-42

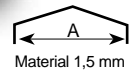
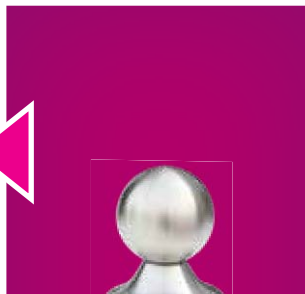

Abdeckkappen
Embouts pyramidaux / Angular caps
Coperchi quadrati ad angolo / Dört köşe kapak

A /mm	Best.-Nr.
30 x 30	1660-3030
30 x 40	1660-3040
40 x 40	1660-4040
50 x 50	1660-5050
60 x 60	1660-6060
80 x 80	1660-8080
100 x 100	1660-1010
120 x 120	1660-1212

AK INOX

Hohlkugeln / Sphères Spheres / Sfere / Küreler



Hohlkugeln
Sphères / Spheres / Sfere / Küreler

øD /mm	Best.-Nr.
20 massiv	1600
25 massiv	1601
30 massiv	1602
40	1603
50	1604
60	1605
70	1606
80	1607
90	1608
100	1609
120	1610
150	1611
200	1612



Halbhohlkugeln
Demi-sphère / Hemisphere
Semisfera / Yarım Küre

øD /mm	Best.-Nr.
20	1640
26,9	1641
30	1642
33,7	1653
40	1643
42,4	1654
48,3	1655
50	1644
60	1645
70	1646
80	1647
90	1648
100	1649
120	1650
150	1651
200	1652

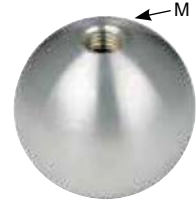

Hohlkugeln, mit Gewinde
Sphères, avec pas de vis / Spheres, with screw hole
Sfere, con foro filettato / Küre, vida delikli

øD /mm	M	Best.-Nr.
20	M6	1600-G
25	M6	1601-G
30	M6	1602-G
40	M8	1603-G
50	M8	1604-G
60	M8	1605-G
70	M8	1606-G
80	M10	1607-G
90	M10	1608-G
100	M10	1609-G
120	M10	1610-G
150	M12	1611-G
200	M12	1612-G

Kugel mit Sackloch / Embout sphérique
Sphere end cap / Coperchio a sfera / Küre, kör delikli

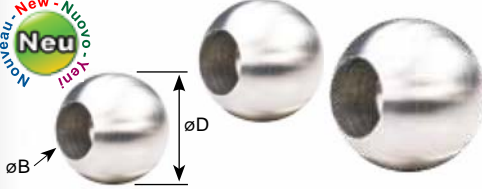

øD /mm	øB /mm	Best.-Nr.
20	12	1600-12
25	12	1601-12
30	12	1602-12

V2A / INOX 304

AK INOX

Zierteile / Accessoires Accessories / Accessori / Aksesuarlar

ø 24 x 50 mm zum Kleben	
øB /mm	Best.-Nr.
10,2	1980-10
12,2	1980-12
14,2	1980-14

ø 24 x 40 mm zum Kleben	
øB /mm	Best.-Nr.
10,2	1981-10
12,2	1981-12
14,2	1981-14

ø 24 x 18 mm zum Kleben	
øB /mm	Best.-Nr.
10,2	1982-10
12,2	1982-12
14,2	1982-14



ø 35 x 24 mm mit Klemmschraube	
øB /mm	Best.-Nr.
10,2	1983-10
12,2	1983-12
14,2	1983-14

ø 30 x 70 mm mit Klemmschraube	
øB /mm	Best.-Nr.
10,2	1984-10
12,2	1984-12
14,2	1984-14

ø 30 x 70 mm mit Klemmschraube	
øB /mm	Best.-Nr.
10,2	1985-10
12,2	1985-12
14,2	1985-14

Top

Top

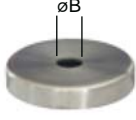

ø 50 x 8 mm

øB /mm	Best.-Nr.
10,5	1207-10
12,5	1207-12
14,5	1207-14

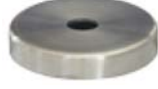

ø 68 x 12 mm

øB /mm	Best.-Nr.
12,5	1205-12
34,0	1205-34



ø 75 x 12 mm

øB /mm	Best.-Nr.
12,5	1206-12
14,5	1206-14
34,0	1206-34
43,0	1206-43
49,0	1206-49



ø 85 x 12 mm

øB /mm	Best.-Nr.
12,5	1218-12
14,5	1218-14
34,0	1218-34



ø 75 x 22 mm

øB /mm	Best.-Nr.
12,5	1210-12
14,5	1210-14
34,0	1210-34



ø 85 x 22 mm

øB /mm	Best.-Nr.
12,5	1219-12
14,5	1219-14
34,0	1219-34



ø 105 x 22 mm

øB /mm	Best.-Nr.
34,0	1216-34
43,0	1216-43
49,0	1216-49



ø 125 x 22 mm

øB /mm	Best.-Nr.
43,0	1217-43
49,0	1217-49



ø 75 x 24 mm

øB /mm	Best.-Nr.
12,5	1201-12
14,5	1201-14
34,0	1201-34



ø 85 x 24 mm

øB /mm	Best.-Nr.
12,5	1202-12
14,5	1202-14
34,0	1202-34



ø 105 x 38 mm

øB /mm	Best.-Nr.
34,0	1203-34
43,0	1203-43
49,0	1203-49



ø 125 x 38 mm

øB /mm	Best.-Nr.
43,0	1204-43
49,0	1204-49



Designstäbe / Barreaux design
Design bars / Barre decorative / Dizayn Çubuklar

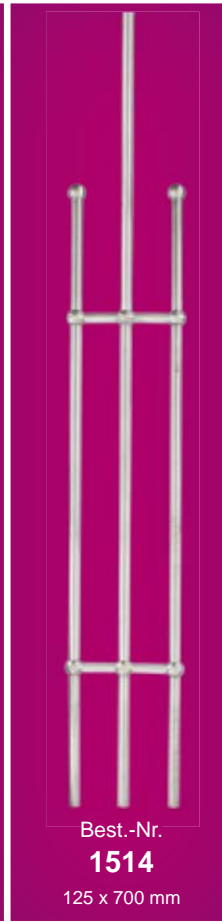
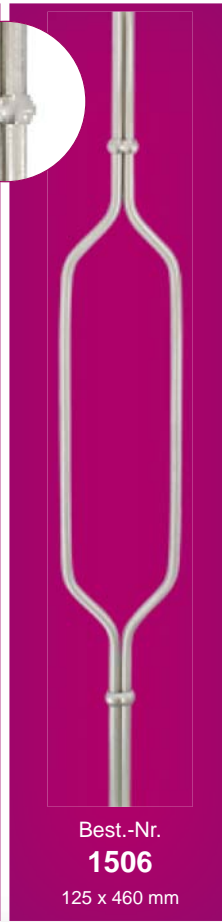
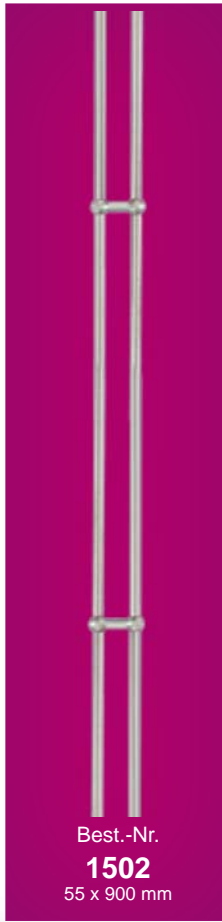
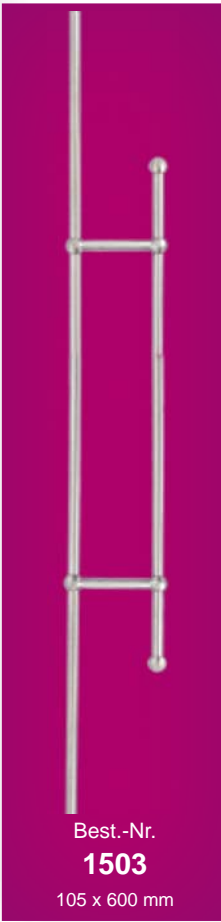
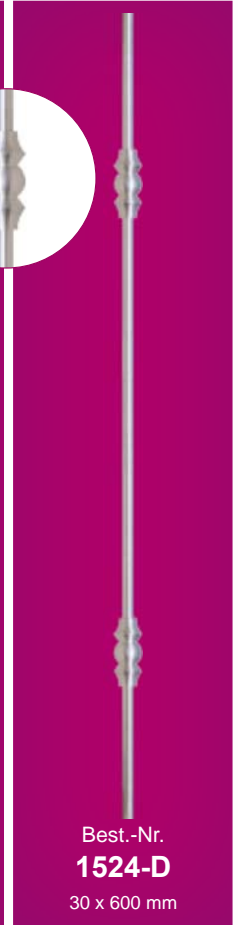
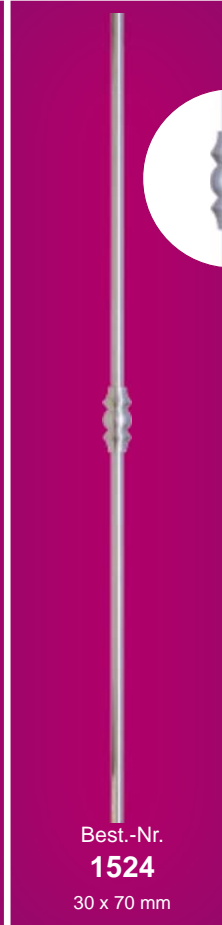
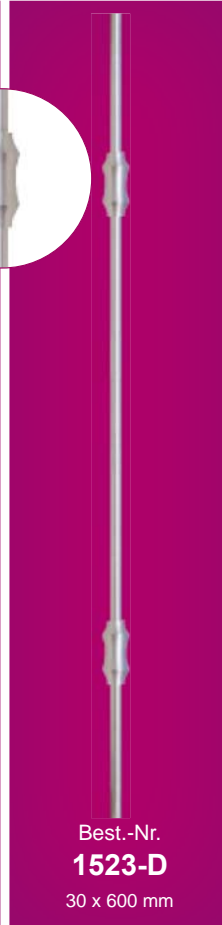
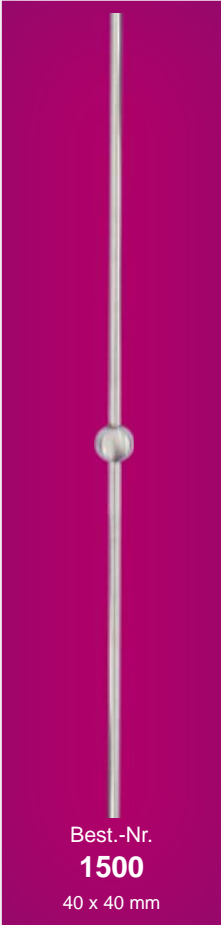

V2A / INOX 304

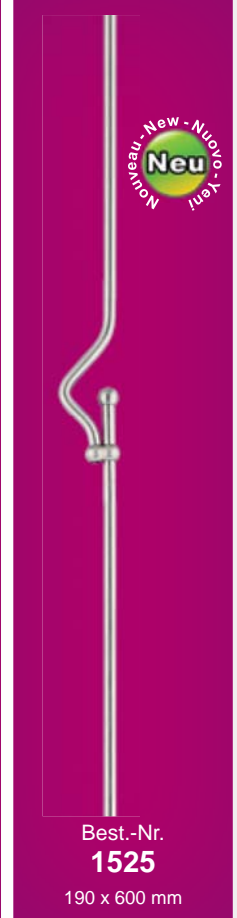
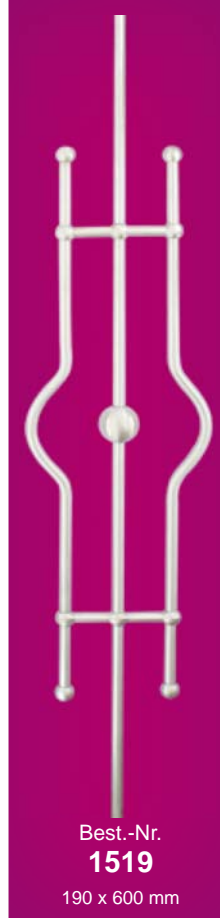
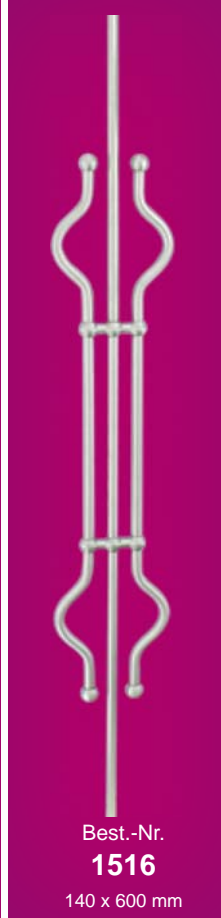
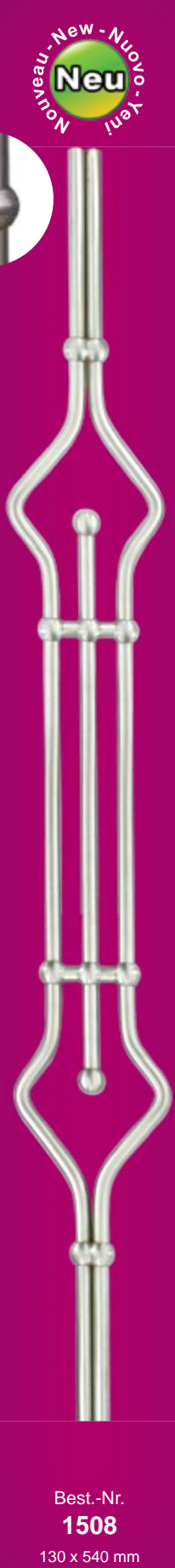

Oval - Ringe / Anneau oval
Oval ring / Anello ovale / Oval halka

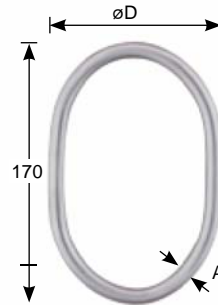

øD /mm	A /mm	Best.-Nr.
100	12	1581-100-12
110	12	1581-110-12
120	12	1581-120-12

Ringe / Anneau
Ring / Anello / Halka

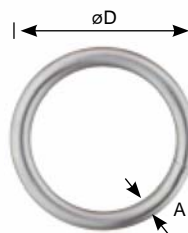

øD /mm	A /mm	Best.-Nr.
100	12	1580-100-12
110	12	1580-110-12
120	12	1580-120-12

Edelstahlverarbeitung Stemke, D-79353 Bahlingen



V2A / INOX 304

Metallbau Cziep, D - 26345 Bockhorn



Edelstahlverarbeitung Stemke, D-79353 Bahlingen

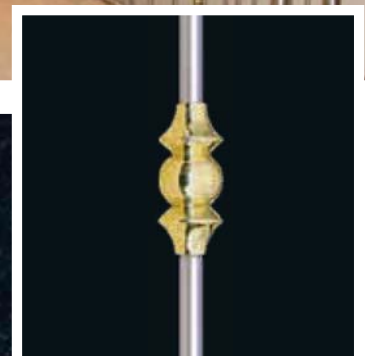
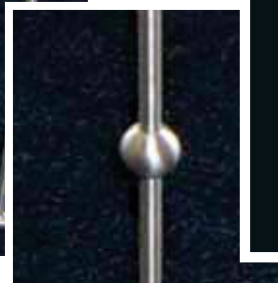
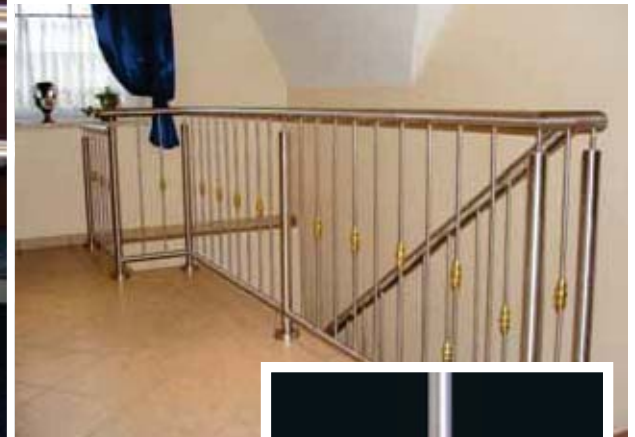

Edelstahlverarbeitung Sternke, D-79353 Bahlingen



Bauschosserei Hauck, D - 97267 Himmelstadt



Bauschosserei Hauck, D - 97267 Himmelstadt



Egon Haist GmbH, D - 72270 Baiersbronn



V2A / INOX 304

Querstabhalter mit Rundanschluss

Support transversal percé, terminaison concave / Bar holder with concave back
Supporto per tubo con lato concavo / Çubuk tutucu yüzük, arkası radyuslu

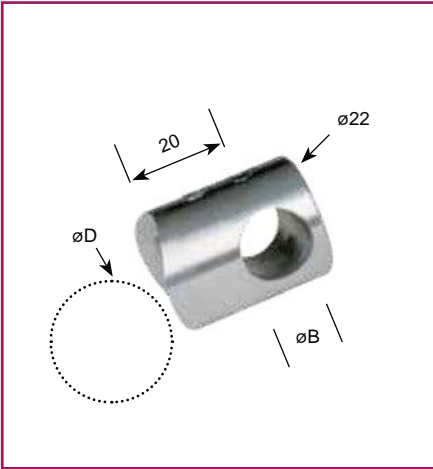

øD /mm	øB /mm	Best.-Nr.
33,7	10,2	1970-3310
33,7	12,2	1970-3312
42,4	10,2	1970-4210
42,4	12,2	1970-4212
48,3	10,2	1970-4810
48,3	12,2	1970-4812

øD /mm	øB /mm	Best.-Nr.
33,7	10,2	1971-3310
33,7	12,2	1971-3312
42,4	10,2	1971-4210
42,4	12,2	1971-4212
48,3	10,2	1971-4810
48,3	12,2	1971-4812

øD /mm	øB /mm	Best.-Nr.
33,7	10,2	1972-3310
33,7	12,2	1972-3312
42,4	10,2	1972-4210
42,4	12,2	1972-4212
48,3	10,2	1972-4810
48,3	12,2	1972-4812

Querstabhalter mit Rundanschluss und Sackloch

Support transversal percé, trou borgne / End post bar holder with concave back
Supporto cieco per tubo con lato concavo / Arkası radyuslu çubuk tutucu kör yüzük

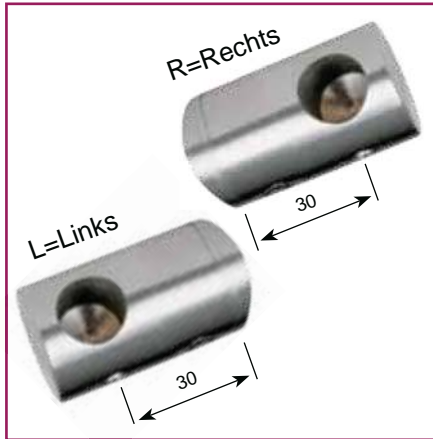

øD /mm	øB /mm	Best.-Nr.
33,7	10,2	1973-3310-R
33,7	10,2	1973-3310-L
33,7	12,2	1973-3312-R
33,7	12,2	1973-3312-L
42,4	10,2	1973-4210-R
42,4	10,2	1973-4210-L
42,4	12,2	1973-4212-R
42,4	12,2	1973-4212-L
48,3	10,2	1973-4810-R
48,3	10,2	1973-4810-L
48,3	12,2	1973-4812-R
48,3	12,2	1973-4812-L

øD /mm	øB /mm	Best.-Nr.
33,7	10,2	1974-3310-R
33,7	10,2	1974-3310-L
33,7	12,2	1974-3312-R
33,7	12,2	1974-3312-L
42,4	10,2	1974-4210-R
42,4	10,2	1974-4210-L
42,4	12,2	1974-4212-R
42,4	12,2	1974-4212-L
48,3	10,2	1974-4810-R
48,3	10,2	1974-4810-L
48,3	12,2	1974-4812-R
48,3	12,2	1974-4812-L

øD /mm	øB /mm	Best.-Nr.
33,7	10,2	1975-3310-R
33,7	10,2	1975-3310-L
33,7	12,2	1975-3312-R
33,7	12,2	1975-3312-L
42,4	10,2	1975-4210-R
42,4	10,2	1975-4210-L
42,4	12,2	1975-4212-R
42,4	12,2	1975-4212-L
48,3	10,2	1975-4810-R
48,3	10,2	1975-4810-L
48,3	12,2	1975-4812-R
48,3	12,2	1975-4812-L

Querstabhalter mit Flachanschluss

Support transversal percé, terminaison droite / Bar holder with flat back
Supporto per tubo con lato piatto / Çubuk tutucu yüzük, arkası düz

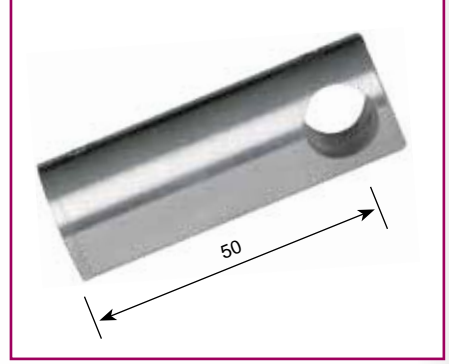
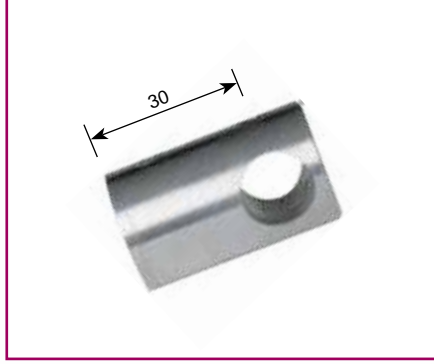
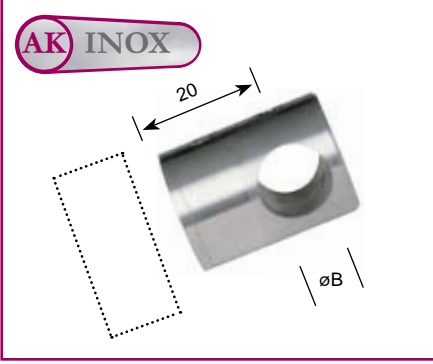

øB /mm	Best.-Nr.
10,2	1970-10
12,2	1970-12

øB /mm	Best.-Nr.
10,2	1971-10
12,2	1971-12

øB /mm	Best.-Nr.
10,2	1972-10
12,2	1972-12

Querstabhalter mit Flachanschluss und Sackloch

Support transversal percé, trou borgne, terminaison droite / End post bar holder with flat back
Supporto cieco per tubo con lato piatto / Arkası düz çubuk tutucu kör yüzük

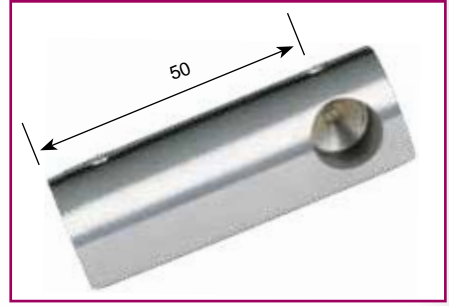
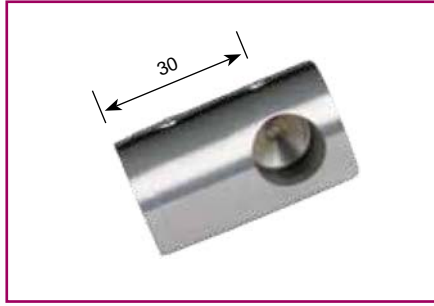
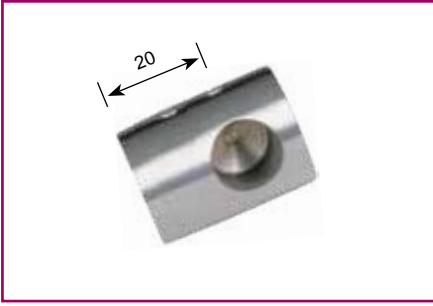

øB /mm	Best.-Nr.
10,2	1973-10-R
10,2	1973-10-L
12,2	1973-12-R
12,2	1973-12-L

øB /mm	Best.-Nr.
10,2	1974-10-R
10,2	1974-10-L
12,2	1974-12-R
12,2	1974-12-L

øB /mm	Best.-Nr.
10,2	1975-10-R
10,2	1975-10-L
12,2	1975-12-R
12,2	1975-12-L

New - Nuovo - Yeni

øD /mm	øB /mm	Best.-Nr.
42,4	10,2	1970-4210 D
42,4	12,2	1970-4212 D

"ecoline"

Top

øD /mm	øB /mm	Best.-Nr.
42,4	12,2	1970-4212 E

Querstabhalter mit Doppelbohrung
Support transversal percé, deux trous
Bar holder with double hole
Supporto per tubo con doppio foro
Çift delikli çubuk tutucu

New - Nuovo - Yeni

øB /mm	Best.-Nr.
10,2 - 12,2	1976-1012
12,2 - 12,2	1976-1212

INOX Form 1

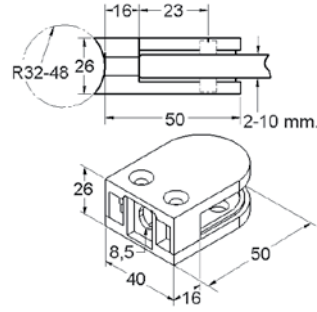

Für Flach (G)
Profil plat
Flat Back
Profilo piatto
Düz tabana
monte

Für Rund (R)
Profil incurvé
Curved Back
Profilo ricurvo
Yuvarlak boruya
monte

Für Glas
Epaisseur de vitre
Glass thickness
Spessore del vetro
Cam kalınlığı

00 ø 32, 42, 48 mm 2-10 mm

	R /mm	Best.-Nr.
V2A / Inox 304	00	1841-G
	32	1841-R32
	42	1841-R42
	48	1841-R48
V4A / Inox 316	00	1840-G
	32	1840-R32
	42	1840-R42
	48	1840-R48

INOX Form 2

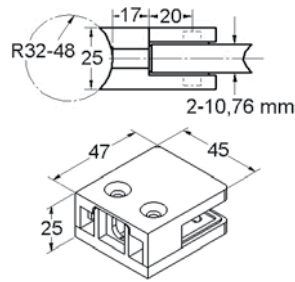

Für Flach (G)
Profil plat
Flat Back
Profilo piatto
Düz tabana
monte

Für Rund (R)
Profil incurvé
Curved Back
Profilo ricurvo
Yuvarlak boruya
monte

Für Glas
Epaisseur de vitre
Glass thickness
Spessore del vetro
Cam kalınlığı

00 ø 32, 42, 48 mm 2-10,76 mm

	R /mm	Best.-Nr.
V2A / Inox 304	00	1851-G
	32	1851-R32
	42	1851-R42
	48	1851-R48
V4A / Inox 316	00	1850-G
	32	1850-R32
	42	1850-R42
	48	1850-R48

INOX Form 3

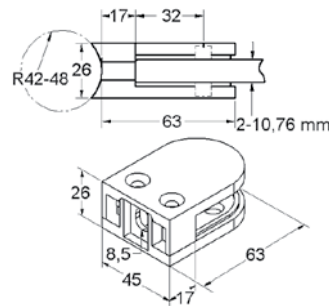

Für Flach (G)
Profil plat
Flat Back
Profilo piatto
Düz tabana
monte

Für Rund (R)
Profil incurvé
Curved Back
Profilo ricurvo
Yuvarlak boruya
monte

Für Glas
Epaisseur de vitre
Glass thickness
Spessore del vetro
Cam kalınlığı

00 ø 32, 42, 48 mm 2-10,76 mm

	R /mm	Best.-Nr.
V2A / Inox 304	00	1861-G
	32	1861-R32
	42	1861-R42
	48	1861-R48
V4A / Inox 316	00	1860-G
	32	1860-R32
	42	1860-R42
	48	1860-R48

Für Flach (G)
Profil plat
Flat Back
Profilo piatto
Düz tabana
monte

Für Rund (R)
Profil incurvé
Curved Back
Profilo ricurvo
Yuvarlak boruya
monte

Für Glas
Epaisseur de vitre
Glass thickness
Spessore del vetro
Cam kalınlığı

00 ø 42, 48, 60 mm 10-12,76 mm

	R /mm	Best.-Nr.
V2A / Inox 304	00	1881-G
	42	1881-R42
	48	1881-R48
	60	1881-R60
V4A / Inox 316	00	1880-G
	42	1880-R42
	48	1880-R48
	60	1880-R60

INOX Form 4

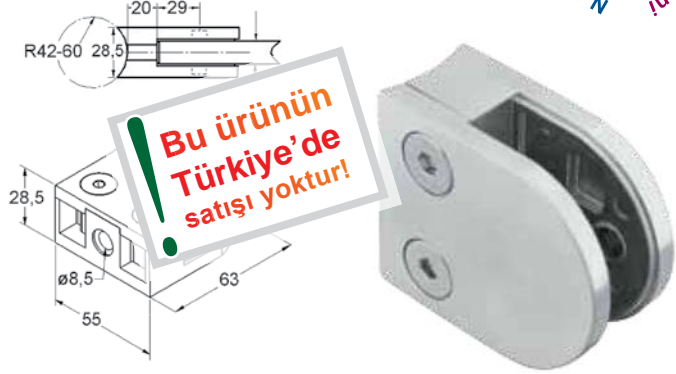

Für Flach (G)
Profil plat
Flat Back
Profilo piatto
Düz tabana
monte

Für Rund (R)
Profil incurvé
Curved Back
Profilo ricurvo
Yuvarlak boruya
monte

Für Glas
Epaisseur de vitre
Glass thickness
Spessore del vetro
Cam kalınlığı

00 ø 42, 48, 60 mm 10-12,76 mm

	R /mm	Best.-Nr.
V2A / Inox 304	00	1891-G
	42	1891-R42
	48	1891-R48
	60	1891-R60
V4A / Inox 316	00	1890-G
	42	1890-R42
	48	1890-R48
	60	1890-R60

INOX Form 5



Bitte vergessen Sie nicht, bei Ihrer Bestellung Glasstärke und Glasart (VSG oder ESG) anzugeben.

N'oubliez pas dire l'épaisseur et le type de vitre (sécurité ou laminé) dans vos commandes.

Don't forget to notify thickness and kind of glass (security or laminated) in your orders.

Cortesemente, menzionare lo spessore e la tipologia di vetro (di sicurezza o laminato) nel vostro ordine

Lütfen cam tutucusunda kullanılan cam kalınlığını ve özelliğini (lamine veya emniyet camı) belirtiniz.



INOX Form 8

	R /mm	Best.-Nr.
V2A / Inox 304	00	1871-G
	32	1871-R32
	42	1871-R42
	48	1871-R48
V4A / Inox 316	00	1870-G
	32	1870-R32
	42	1870-R42
	48	1870-R48



AK INOX

G = R00

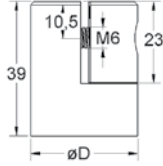

Blechhalter mit Flachanschluss
Pince de fixation droite
Clamp holder with flat back
Portatarga piatto
Plaka tutucu, arkası düz

New - Nuovo - Yeni
 Neu
 Nuova - Nuovo - Yeni

Bu ürünün Türkiye'de satışı yoktur!

Blechhalter mit Rundanschluss
Pince de fixation concave
Clamp holder with concave back
Portatarga ricurvo
Plaka tutucu, arkası radyuslu

New - Nuovo - Yeni
 Neu
 Nuova - Nuovo - Yeni

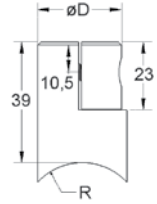

	R /mm	Best.-Nr.	D = ø 32mm Best.-Nr.
V2A / Inox 304	00	1887-G	1886-G
	32	1887-R32	1886-R32
	42	1887-R42	1886-R42
	48	1887-R48	1886-R48

AK ZAMAK

Klemmbefestigungen / Pinces de vitre
Glass clamps / Supporti a clip per vetro / Cam tutucuları

Für Flach (G)
 Profil plat
 Flat Back
 Profilo piatto
 Düz tabana
 monte

00

Für Rund (R)
 Profil incurvé
 Curved Back
 Profilo ricurvo
 Yuvarlak boruya
 monte

ø 32, 42, 48 mm

Für Glas
 Epaisseur de vitre
 Glass thickness
 Spessore del vetro
 Cam kalınlığı

2-10 mm

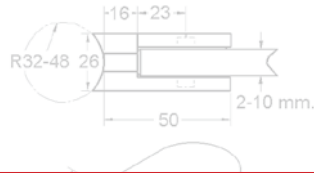

Oberfläche
 Revêtement
 Surface
 Superficie
 Yüzey

Zink
 Zinc Mat
 Zamak
 Zinco
 Zamak

Edelstahl-Effekt
 Apparence inox
 Inox Visual
 Simil-Inox
 Paslanmaz Görünüm

R /mm

Best.-Nr.

00	1811-G
32	1811-R32
42	1811-R42
48	1811-R48
00	1819-G
32	1819-R32
42	1819-R42
48	1819-R48

Zamak bölümüne bakınız...

Für Flach (G)
 Profil plat
 Flat Back
 Profilo piatto
 Düz tabana
 monte

00

Für Rund (R)
 Profil incurvé
 Curved Back
 Profilo ricurvo
 Yuvarlak boruya
 monte

ø 32, 42, 48 mm

Für Glas
 Epaisseur de vitre
 Glass thickness
 Spessore del vetro
 Cam kalınlığı

2-10,76 mm

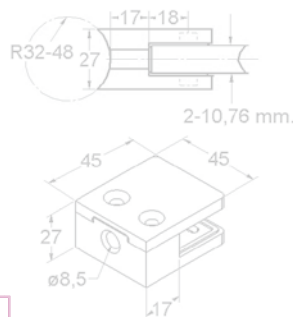

Oberfläche
 Revêtement
 Surface
 Superficie
 Yüzey

Zink
 Zinc Mat
 Zamak
 Zinco
 Zamak

Edelstahl-Effekt
 Apparence inox
 Inox Visual
 Simil-Inox
 Paslanmaz Görünüm

R /mm

Best.-Nr.

00	1821-G		
32	1821-R32		
42	1821-R42		
48	1821-R48		
00	1829-G		
32	1829-R32		
42	1829-R42		
48	1829-R48		
RAL 9010	Weiss	00	1822-G
	Blanc	32	1822-R32
	White	42	1822-R42
	Bianco	48	1822-R48
Beyaz			

Oberflaeche Revêtement Surface Superficie Yüzey	R /mm	Best.-Nr.
Zink Zinc Mat Zamak Zinco Zamak	00 32 42 48	1831-G 1831-R32 1831-R42 1831-R48
Edelstahl-Effekt Apparence inox Inox Visual Simil-Inox Paslanmaz Görünüm	00 32 42 48	1839-G 1839-R32 1839-R42 1839-R48
RAL 9010 Weiss Blanc White Bianco Beyaz	00 32 42 48	1832-G 1832-R32 1832-R42 1832-R48

Für Flach (G) Profil plat Flat Back Profilo piatto Düz tabana monte	Für Rund (R) Profil incurvé Curved Back Profilo ricurvo Yuvarlak boruya monte	Für Glas Epaisseur de vitre Glass thickness Spessore del vetro Cam kalınlığı
00	ø 32, 42, 48 mm	2-10,76 mm

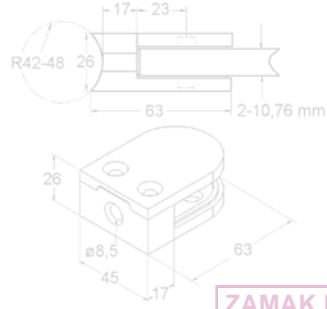

ZAMAK Form 3



Oberflaeche Revêtement Surface Superficie Yüzey	R /mm	Best.-Nr.
Edelstahl-Effekt Apparence inox Inox Visual Simil-Inox Paslanmaz Görünüm	00 42 48 60	1889-G 1889-R42 1889-R48 1889-R60
RAL 9010 Weiss Blanc White Bianco Beyaz	00 42 48 60	1882-G 1882-R42 1882-R48 1882-R60

Zamak bölümüne bakınız...



ZAMAK Form 4



Oberflaeche Revêtement Surface Superficie Yüzey	R /mm	Best.-Nr.
Zink Zinc Mat Zamak Zinco Zamak	00 42 48 60	1895-G 1895-R42 1895-R48 1895-R60
Edelstahl-Effekt Apparence inox Inox Visual Simil-Inox Paslanmaz Görünüm	00 42 48 60	1899-G 1899-R42 1899-R48 1899-R60
RAL 9010 Weiss Blanc White Bianco Beyaz	00 42 48 60	1892-G 1892-R42 1892-R48 1892-R60

Für Flach (G) Profil plat Flat Back Profilo piatto Düz tabana monte	Für Rund (R) Profil incurvé Curved Back Profilo ricurvo Yuvarlak boruya monte	Für Glas Epaisseur de vitre Glass thickness Spessore del vetro Cam kalınlığı
00	ø 42, 48, 60 mm	10-12,76 mm



ZAMAK Form 5





Metallbau Dotterweich GmbH & Co KG, D-97497 Dingolshausen



Metallbau Dotterweich GmbH & Co KG, D-97497 Dingolshausen



Fa. Bauer, D - 53489 Sinzig



Fa. Bauer, D - 53489 Sinzig



Fa. Bauer, D - 53489 Sinzig



Fa. Bauer, D - 53489 Sinzig



Ebert Metalldesign, D- 65396 Walluf



Ebert Metalldesign, D- 65396 Walluf



Gisela Grote GmbH & Co KG, D - 34260 Kaufingen

Ebert Metalldesign, D- 65396 Walluf

Top



Top



øD/mm	Best.-Nr.
33,7	1268-33
42,4	1268-42
48,3	1268-48

øD/mm	Best.-Nr.
33,7	1267-33
42,4	1267-42
48,3	1267-48

øD/mm	Best.-Nr.
33,7	1266-33
42,4	1266-42
48,3	1266-48

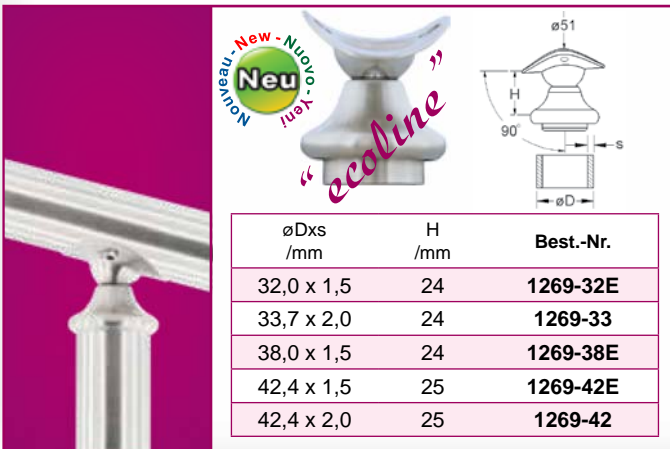

øDxs /mm	H /mm	Best.-Nr.
32,0 x 1,5	24	1269-32E
33,7 x 2,0	24	1269-33
38,0 x 1,5	24	1269-38E
42,4 x 1,5	25	1269-42E
42,4 x 2,0	25	1269-42

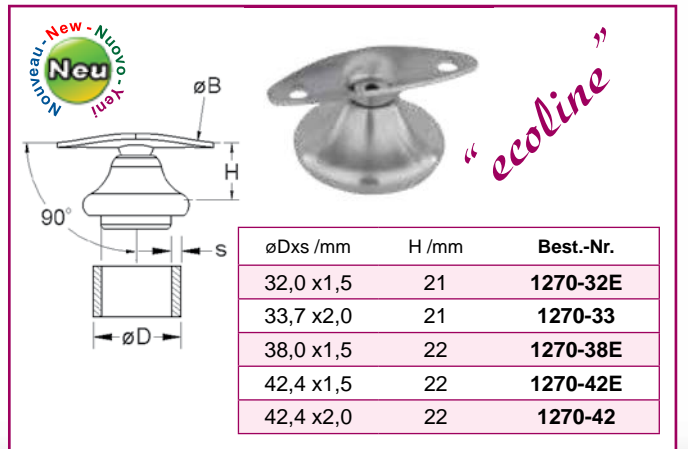

øDxs /mm	H /mm	Best.-Nr.
32,0 x 1,5	21	1270-32E
33,7 x 2,0	21	1270-33
38,0 x 1,5	22	1270-38E
42,4 x 1,5	22	1270-42E
42,4 x 2,0	22	1270-42

Best-Nr. 1225
Ø12 mm
75 mm
75 mm

Best-Nr. 1226
75 mm
75 mm

Best-Nr. 1229
100
70
M8 x 10 mm

Best-Nr. 1229-G
100
70
M8 x 10 mm

Best-Nr. 1228
75 mm
75 mm
M8 x 10 mm

Best-Nr. 1247-10
øD /mm øD1 /mm
60 10

Best-Nr. 1247-12
70 12

Best-Nr. 1247-10-G
øD /mm øD1 /mm
60 10

Best-Nr. 1247-12-G
70 12

Best-Nr. 1280
33,7 65

Best-Nr. 1281
42,4 65

Best-Nr. 1282
48,3 65

Best-Nr. 1283
33,7 80

Best-Nr. 1284
42,4 80

Best-Nr. 1285
48,3 80

Best-Nr. 1279-65
L x w x s /mm
65x25x3

Best-Nr. 1290
L /mm
65

Best-Nr. 1291
100

Best-Nr. 1292
L /mm
65

Best-Nr. 1293
100



Handlaufträger mit Abschlusskugel
Support de main courante avec anneau borgne
Handrail bracket with blind sphere ring
Supporto semisferico cieco per corrimano
Kolçak, kör küre yüzüklü

øD /mm	Best.-Nr.
33,7	1250
42,4	1251

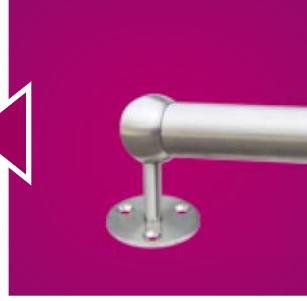

Handlaufträger mit Kugelring
Support de main courante avec anneau
Handrail bracket with sphere ring
Supporto ad anello sferico per corrimano
Kolçak, küre yüzüklü

øD /mm	Best.-Nr.
33,7	1252
42,4	1253

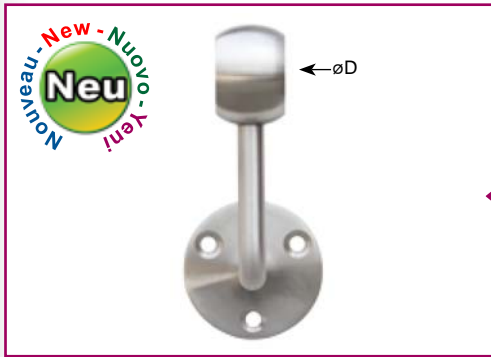

Handlaufträger mit Kugelring
Support de main courante avec anneau
Handrail bracket with sphere ring
Supporto ad anello sferico per corrimano
Kolçak, küre yüzüklü

øD /mm	Best.-Nr.
33,7	1245
42,4	1246

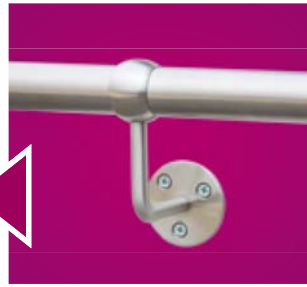

Handlaufträger mit Abschlusskugel
Support de main courante avec anneau borgne
Handrail bracket with blind sphere ring
Supporto semisferico cieco per corrimano
Kolçak, kör küre yüzüklü

øD /mm	Best.-Nr.
33,7	1243
42,4	1244

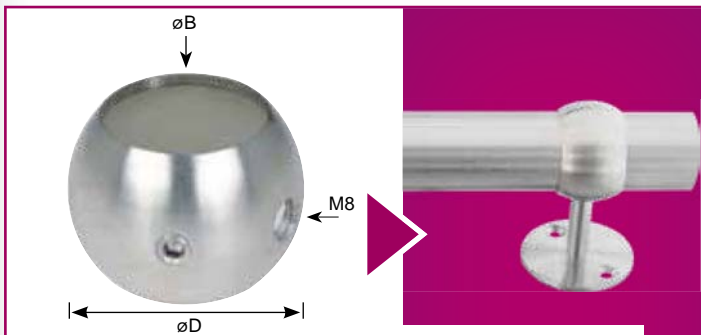

Kugel-Ring
Anneau sphérique / Sphere ring
Supporto ad anello sferico per corrimano / Küre yüzük

øB /mm	øD /mm	Best.-Nr.
26,9	40	1054
33,7	45	1055
42,4	55	1056
48,3	60	1057

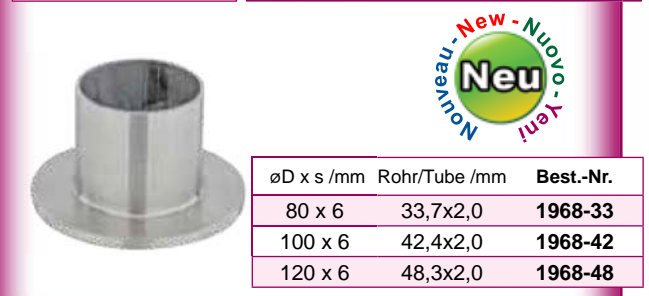
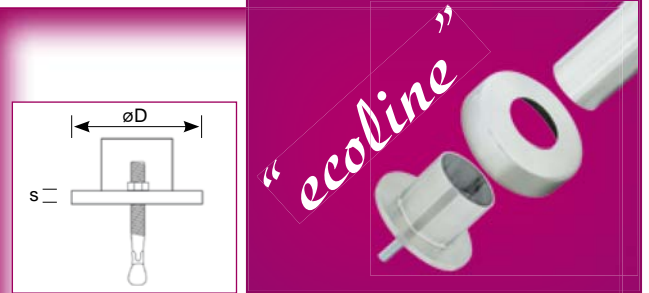

øD x s /mm	Rohr/Tube /mm	Best.-Nr.
80 x 6	33,7x2,0	1968-33
100 x 6	42,4x2,0	1968-42
120 x 6	48,3x2,0	1968-48



øB /mm	Best.-Nr.
34	1963-33
43	1963-42
49	1963-48

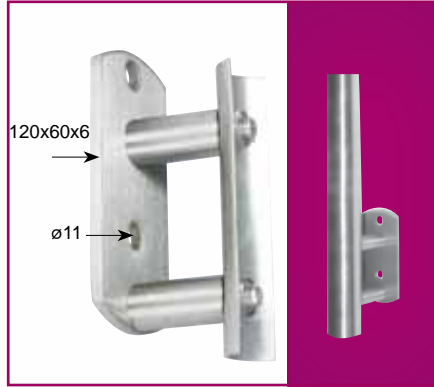

Rohr/Tube /mm	Best.-Nr.
33,7	1961-33
42,4	1961-42
48,3	1961-48



Rohr/Tube /mm	Best.-Nr.
33,7	1960-33
42,4	1960-42
48,3	1960-48

Abstandshülse / Rallonge / Extension bar / Estensione / Montaj Çubuğu

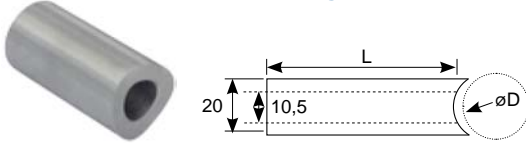

L /mm	øD /mm	Best.-Nr.
40	33,7	1969-40
70	42,4	1969-70
100	48,3	1969-100



øB /mm	Best.-Nr.
33,7	1962-33
42,4	1962-42
48,3	1962-48



øB /mm	Best.-Nr.
33,7	1964-33
42,4	1964-42
48,3	1964-48

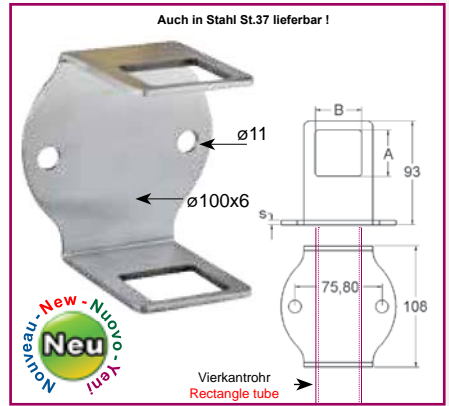

A /mm	B /mm	Best.-Nr.
30	30	1965-30
40	40	1965-40

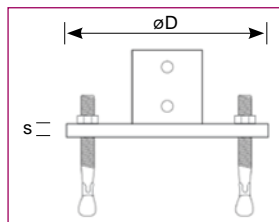

øD x s /mm	Rohr/Tube /mm	Best.-Nr.
80 x 6	33,7x2,0	1966-33
100 x 6	42,4x2,0	1966-42
120 x 6	48,3x2,0	1966-48

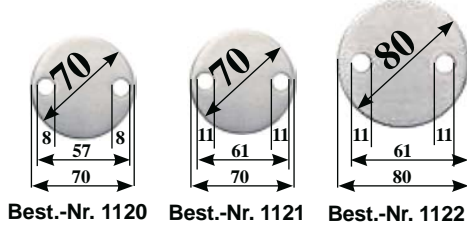
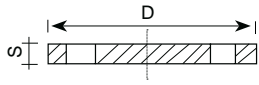

Best.-Nr. 1120 Best.-Nr. 1121 Best.-Nr. 1122

D x s /mm	Best.-Nr.
70 x 4	1120
70 x 6	1121
80 x 6	1122

Alle Ronden mit „plus Service“ Kanten bearbeitet!

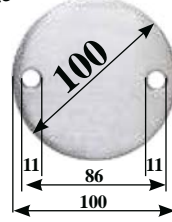

Best.-Nr. 1123

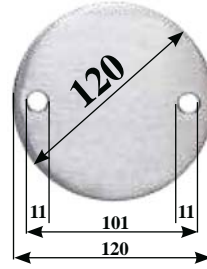

Best.-Nr. 1124

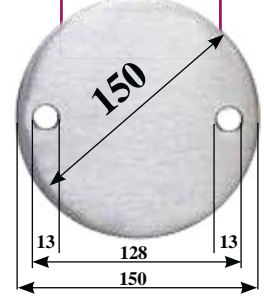

Best.-Nr. 1128

Top

D x s /mm	Best.-Nr.
100 x 6	1123

D x s /mm	Best.-Nr.
120 x 6	1124
150 x 6	1128

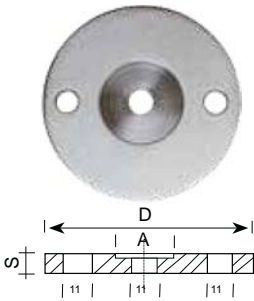

D x s /mm	A /mm	Best.-Nr.
80 x 6	34 x 1	1127-34
100 x 6	43 x 1	1127-43
120 x 6	49 x 1	1127-49

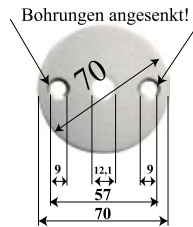

Best.-Nr. 1130

D x s /mm	Best.-Nr.
70 x 4	1130

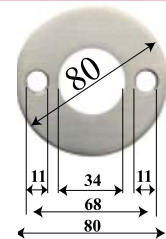

Best.-Nr. 1131

D x s /mm	Best.-Nr.
80 x 6	1131

Alle Ronden mit „plus Service“ Kanten bearbeitet!

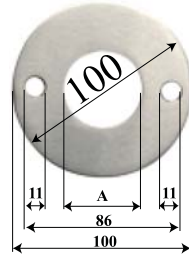

D x s /mm	A /mm	Best.-Nr.
100 x 6	34	1132-34
100 x 6	43	1132-43
100 x 6	49	1132-49

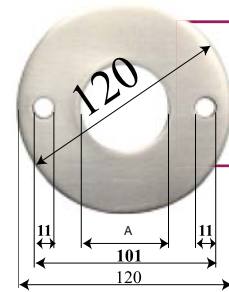

D x s /mm	A /mm	Best.-Nr.
120 x 6	34	1133-34
120 x 6	43	1133-43
120 x 6	49	1133-49



D x s /mm	Best.-Nr.
27 x 2	1111
33 x 2	1112
33 x 4	1100
42 x 2	1113
42 x 4	1101
48 x 4	1102
60 x 4	1103
70 x 4	1104
70 x 6	1105
80 x 4	1106
80 x 6	1107
100 x 4	1108
100 x 6	1109
120 x 6	1110
150 x 6	1114

Schale gewölbt, ungeschliffen

Embout bombé, non poli / Domed cap, unpolished
Coperchio a cupola, grezzo / Bombeli kapak, polisajsız

Material 2,0 mm



ø /mm	h /mm	Zoll	Best.-Nr.
21	6	1/2"	1200-21
27	7	3/4"	1200-27
33	8	1"	1200-33
42	9	1 1/4"	1200-42
48	10	1 1/2"	1200-48
52	10	1 3/4"	1200-52
60	11	2"	1200-60
70	11	2 1/4"	1200-70
76	11	2 1/2"	1200-76
89	12	3"	1200-89
101	12	3 1/2"	1200-101
113	13	4"	1200-113
120	13	4 1/2"	1200-120

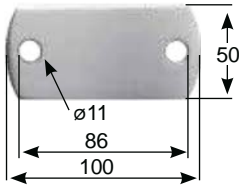

Best.-Nr. 1140

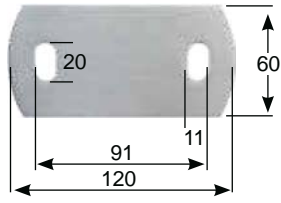

Best.-Nr. 1141

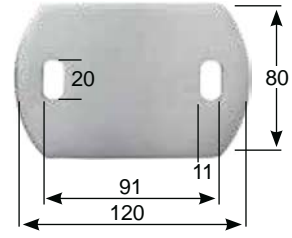

Best.-Nr. 1142

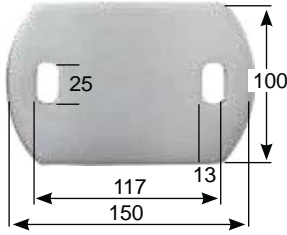

Best.-Nr. 1145

B x H x s /mm	Best.-Nr.
100x50x6	1140
120x60x6	1141
120x80x6	1142
150x100x6	1145
200x125x6	1146

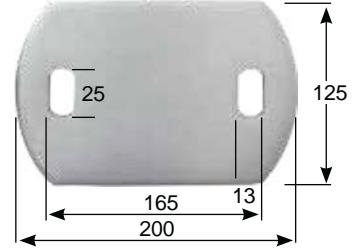

Best.-Nr. 1146

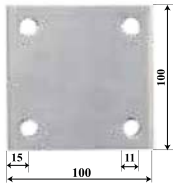

Best.-Nr. 1143

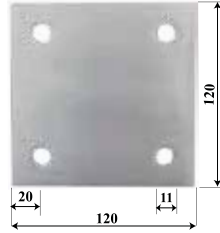

Best.-Nr. 1144



Alle Ronden mit „plus Service“ Kanten bearbeitet!

B x H x s /mm	Best.-Nr.
100x100x6	1143

B x H x s /mm	Best.-Nr.
120x120x6	1144

D x s /mm	Best.-Nr.
64 x 4	1125
64 x 4	1126

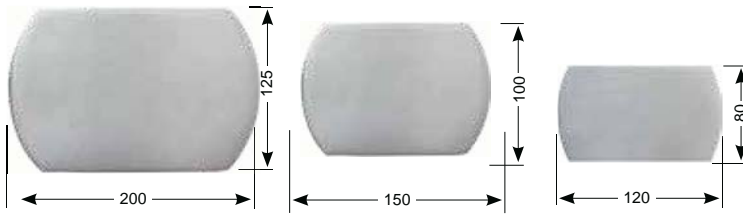

Best.-Nr. 1144-OB

∅D x s /mm	Best.-Nr.	Paket/Stk/paquet
100x100x6	1143-OB	65
120x 80x6	1142-OB	100
120x120x6	1144-OB	44
150x100x6	1145-OB	40
200x125x6	1146-OB	25

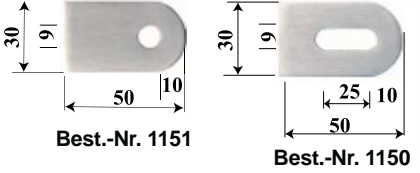

Best.-Nr. 1151

Best.-Nr. 1150

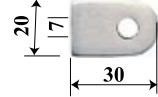

Best.-Nr. 1152

B x H x s /mm	Best.-Nr.
50 x 30 x 4	1150
50 x 30 x 4	1151
30 x 20 x 4	1152

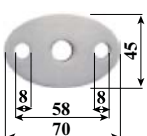

Best.-Nr. 1160

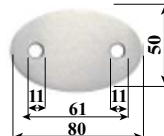

Best.-Nr. 1161

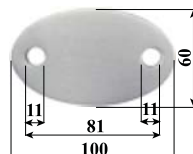

Best.-Nr. 1162

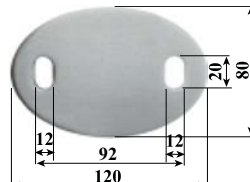

Best.-Nr. 1163

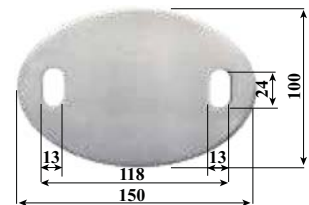

Best.-Nr. 1164

B x H x s /mm	Best.-Nr.
70 x 45 x 4	1160
80 x 50 x 4	1161

B x H x s /mm	Best.-Nr.
100 x 60 x 6	1162
120 x 80 x 6	1163

B x H x s /mm	Best.-Nr.
150 x 100 x 6	1164

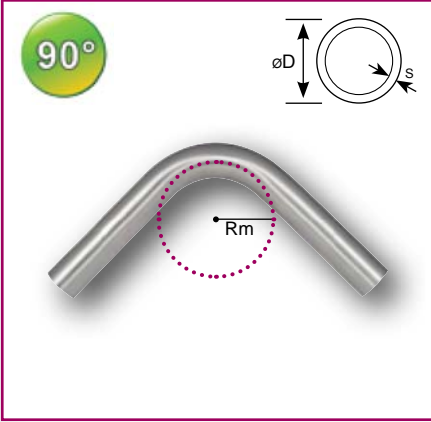

øD x s /mm	Rm	Best.-Nr.
26,9 x 2,0	54	1904-26
33,7 x 2,0	68	1904-33
33,7 x 2,6	68	1904-3326
42,4 x 2,0	86	1904-42
42,4 x 2,6	86	1904-4226
48,3 x 2,6	98	1904-48



øD x s /mm	Rm	Best.-Nr.
26,9 x 2,0	54	1905-26
33,7 x 2,0	68	1905-33
33,7 x 2,6	68	1905-3326
42,4 x 2,0	86	1905-42
42,4 x 2,6	86	1905-4226
48,3 x 2,6	98	1905-48



øD x s /mm	Rm	Best.-Nr.
26,9 x 2,0	54	1906-26
33,7 x 2,0	68	1906-33
33,7 x 2,6	68	1906-3326
42,4 x 2,0	86	1906-42
42,4 x 2,6	86	1906-4226
48,3 x 2,6	98	1906-48



øD x s /mm	Rm	Best.-Nr.
26,9 x 2,0	54	1901-26
33,7 x 2,0	68	1901-33
33,7 x 2,6	68	1901-3326
42,4 x 2,0	86	1901-42
42,4 x 2,6	86	1901-4226
48,3 x 2,6	98	1901-48



øD x s /mm	Rm	Best.-Nr.
26,9 x 2,0	54	1902-26
33,7 x 2,0	68	1902-33
33,7 x 2,6	68	1902-3326
42,4 x 2,0	86	1902-42
42,4 x 2,6	86	1902-4226
48,3 x 2,6	98	1902-48



øD x s /mm	Rm	Best.-Nr.
26,9 x 2,0	54	1903-26
33,7 x 2,0	68	1903-33
33,7 x 2,6	68	1903-3326
42,4 x 2,0	86	1903-42
42,4 x 2,6	86	1903-4226
48,3 x 2,6	98	1903-48

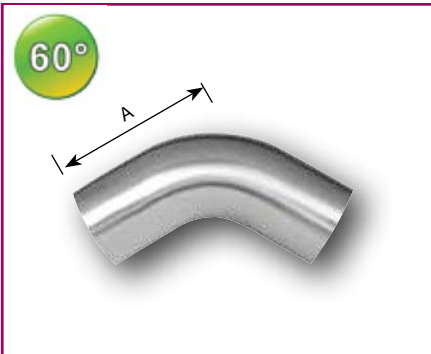

øD x s /mm	A	Best.-Nr.
42,4 x 2,0	79	1903-42-K



øD x s /mm	A	Best.-Nr.
42,4 x 2,0	73	1902-42-K

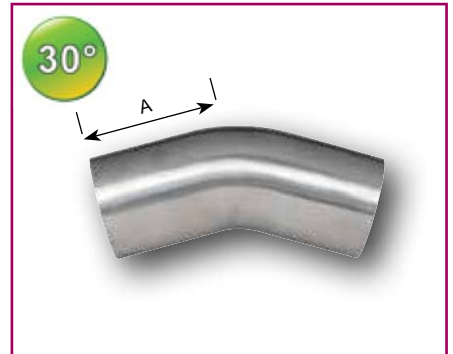

øD x s /mm	A	Best.-Nr. Code
42,4 x 2,0	73	1901-42-K

90°

Poliert
Poli / Polished
Lucidato / Polisajlı

Top



45°



New - Nuovo - Yeni

90° Schweißbogen / Coude
Elbow / Raccordo a gomito / Dirsek
HP- Hochglanz / Haut polissage
Highly polished / Lucidato a specchio / Parlak

øD x s /mm	Rm	Best.-Nr
26,9 x 2,0	27	1924-26
32,0 x 1,5	38	1924-32
32,0 x 1,5	38	1924-32HP
33,7 x 2,0	35	1924-33
42,4 x 2,0	44	1924-42
48,3 x 2,6	54	1924-48
50,8 x 1,5	58	1924-51
50,8 x 1,5	58	1924-51HP

øD x s /mm	Best.-Nr.
33,7 x 2,0	1924-3345
42,4 x 2,0	1924-4245
48,3 x 2,0	1924-4845

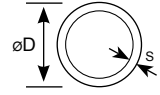
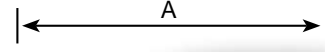

Rohrbogen kurz / Raccord arqué court
Bent tube fitting, short / Raccordo per tubo, corto
Bükümlü boru bağlantı elemanı, kısa

øD x s /mm	A /mm	Best.-Nr.
42,4 x 2,0	110	1904-42-K

Rohrbögen mit Bohrung / Tubes incurvés percés

Tube fittings with holes / Raccordi forati per tubi / Konektör boru bağlantıları

60°

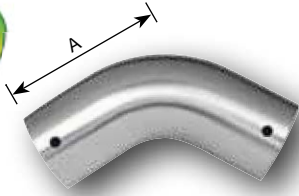

45°

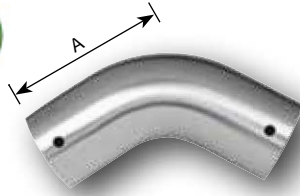

30°

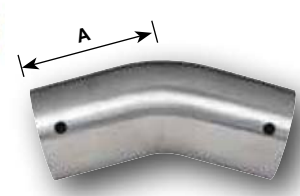

øD x s /mm	A /mm	Best.-Nr.
42,4 x 2,0	79	1903-42-KB

øD x s /mm	A /mm	Best.-Nr.
42,4 x 2,0	73	1902-42-KB

øD x s /mm	A /mm	Best.-Nr.
42,4 x 2,0	73	1901-42-KB

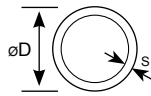
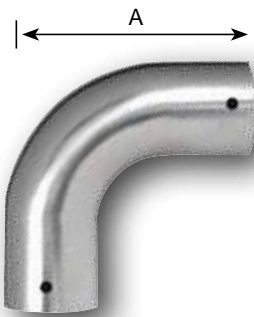

øD x s /mm	A /mm	Best.-Nr.
42,4 x 2,0	110	1904-42-KB

Verbindungshülse / Raccord / Connector / Raccordo / Konektör



Mit Klemmschrauben
Avec vis de serrage / With clamp screws
Con viti a pressione / Sıkıştırma vidaları ile

Passend für Rohrwandstärke 2,0–2,6 mm
Convient à une épaisseur de tube de 2,0 à 2,6 mm
Suitable for 2,0-2,6 mm thickness of tube
Per tubi di spessore 2,0-2,6 mm
2,0-2,6 mm boru kalınlığına göre

8 mm vorgebohrt für Aufnahme der Verbindungshülse
Trou de 8 mm sur le tube
8 mm hole on the face of tube
Foro da 8 mm sulla superficie del tubo
Boru ağzında açılan 8 mm delik



Rohr/Tube /mm	Best.-Nr.
26,9	1951-26
33,7	1951-33
42,4	1951-42
48,3	1951-48

Verbindungshülse einstecken und Gewindestift (im Lieferumfang enthalten) festziehen. Fertig ist die Verbindung in Sekunden !



Rohr/Tube /mm	90 - 145° Best.-Nr.	100 - 165° Best.-Nr.
33,7 x 2,0	1937-1-33	1937-2-33
42,4 x 2,0	1937-1-42	1937-2-42
48,3 x 2,0	1937-1-48	1937-2-48



Bu ürünün Türkiye'de satışı yoktur!

Rohr/Tube /mm	Best.-Nr.
33,7 x 2,0	1938-33
42,4 x 2,0	1938-42
48,3 x 2,0	1938-48



Bu ürünün Türkiye'de satışı yoktur!

Rohr/Tube /mm	Best.-Nr.
33,7 x 2,0	1936-33
42,4 x 2,0	1936-42
48,3 x 2,0	1936-48



Rohr/Tube /mm	Best.-Nr.
33,7 x 2,0	1933-33
42,4 x 2,0	1933-42
48,3 x 2,0	1933-48



Rohr/Tube /mm	Best.-Nr.
33,7	1930-33
42,4	1930-42
48,3	1930-48



Rohr/Tube /mm	Best.-Nr.
33,7	1931-33
42,4	1931-42
48,3	1931-48

Passend für Rohrwandstärke 2,0–2,6 mm
Convient à une épaisseur de tube de 2,0 à 2,6 mm
Suitable for 2,0-2,6 mm thickness of tube
Per tubi di spessore 2,0-2,6 mm
2,0-2,6 mm boru kalınlığına göre

WEICON Klebstoffe / Adhésifs / Adhesivos / Yapıştırıcılar



COSMOPLAST 500L

ein schnellhärtender 1-Komponenten-Klebstoff für die handwerkliche und industrielle Anwendung
cyan-acrylic adhesive

Best.-Nr. **25116**
20 ml,



Bu ürünlerin Türkiye'de satışı yoktur!

WEICONLOCK products are high quality anaerobic adhesives and sealants on the basis of special methacrylate resins, especially made for economical threadlocking, retaining and sealing of threaded, cylindrical and pipe

Best.-Nr. **25110**
20 ml,



Epoxyd-Minutenkleber

2-Komponenten, transparente und restelastisch aushärtende, Klebstoffe, welche die meisten Materialien, wie: Metall, Glas, Stein, Keramik, Holz und viele Kunststoffe mit- und untereinander verbinden.

WEICON Epoxy Minute Adhesive
This transparent adhesive retains elasticity after curing and is ideal for jobs in construction and assembly and in fact in all cases where the use of WEICON Easy-Mix Systems would not be efficient. viscous, self-levelling very short pot life (3 - 4 minutes) fast-curing almost colourless, glass clear.

Best.-Nr. **25113**
24 ml,

AK INOX

Steckfittings / Raccords

Tube fittings / Raccordi per tubi / Geçme boru bağlantıları



Rohr Tube /mm	Best.-Nr.
33,7 x 2,0	1911-33
42,4 x 2,0	1911-42
48,3 x 2,0	1911-48

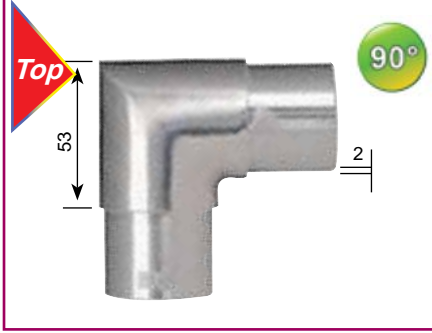

Rohr Tube /mm	Best.-Nr.
33,7 x 2,0	1910-33
42,4 x 2,0	1910-42
48,3 x 2,0	1910-48



Rohr Tube /mm	Best.-Nr.
42,4 x 2,0	1913-42



Rohr Tube /mm	Best.-Nr.
33,7 x 2,0	1918-33
42,4 x 2,0	1918-42
48,3 x 2,0	1918-48



Rohr Tube /mm	Best.-Nr.
33,7 x 2,0	1919-33
42,4 x 2,0	1919-42
48,3 x 2,0	1919-48



Rohr Tube /mm	Best.-Nr.
33,7 x 2,0	1912-33
42,4 x 2,0	1912-42
48,3 x 2,0	1912-48



øD /mm	Best.-Nr.
33,7 x 2,0	1916-33
42,4 x 2,0	1916-42
48,3 x 2,0	1916-48

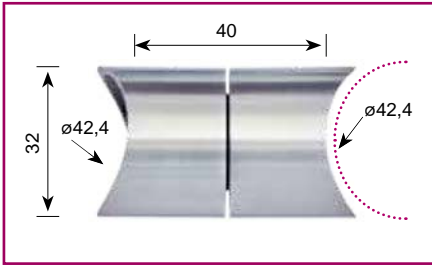

Anschlussstück Connecteur / Connecting fitting Connettore / Bağlantı parçası	
Rohr Tube /mm	Best.-Nr.
42,4-42,4	1925-4242

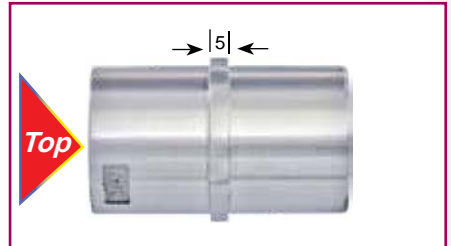

Rohr Tube /mm	Best.-Nr.
33,7 x 2,0	1917-33
42,4 x 2,0	1917-42
48,3 x 2,0	1917-48

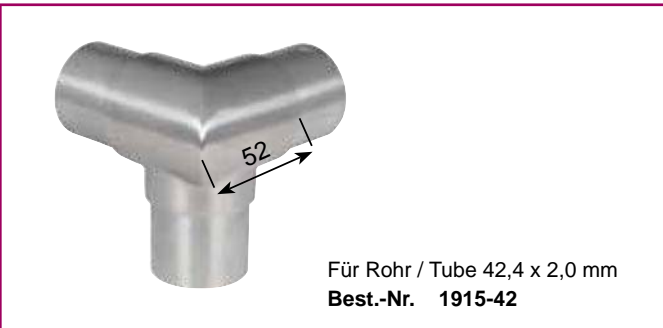

Schlossgehäuse und Gegenkästen / Boîtiers de serrure et gâches Locking and striking cases / Serratura e controbochetta / Kilit ve karşılık kasaları



Schlossgehäuse,
Links oder Rechts verwendbar, 2-tourig
Boîtier en inox,
Disponibile droite et gauche, à 2 tours.
Lock case,
Left or right side usage with 2-tours lock.
Serratura,
Utilizzabile sia a destra che a sinistra,
scrocco a doppio giro.
Kilit kasası
Sağ ve Sol olarak kullanılabilir,
iki türlü kilit ile.

B x H x T /mm	Best.-Nr.
96 x 172 x 30	1304-30
96 x 172 x 34	1304-34
96 x 172 x 40	1304-40
96 x 172 x 50	1304-50

E = 72 mm, A = 60 mm



Gegenkasten
Gehäuse und Schliessblech
Gâche,
Boîtier et platine de gâche
Striking case,
Lock case and striking plate
Controbochetta,
Serratura e controbochetta
Karşılık kasası
Kasa ve ayna

B x H x T /mm	Best.-Nr.
96 x 172 x 30	1324-30
96 x 172 x 34	1324-34
96 x 172 x 40	1324-40
96 x 172 x 50	1324-50



Schmales Schlossgehäuse,
Links oder Rechts verwendbar, 1-tourig
Boîtier de serrure étroit,
Utilisable droite et gauche, serrure à un tour
Narrow lock case,
Left or right side usage with 1-tour lock
Serratura stretta,
Utilizzo a destra o sinistra, serratura a giro singolo
Dar kilit kasası
Sağ ve sol olarak kullanılabilir, bir türlü kilit ile

B x H x T /mm	Best.-Nr.
60 x 172 x 30	1305
60 x 172 x 40	1305-40



Schlossgehäuse mit Hakenfalle
Boîtier de serrure à crochet pour porte
coulissante
Lock case for sliding doors with hook
Serratura per porta scorrevole, ad uncino
Kilit kasası kancalı kilit ile

B x H x T /mm	Best.-Nr.
96 x 172 x 30	1306-30
96 x 172 x 34	1306-34
96 x 172 x 40	1306-40
96 x 172 x 50	1306-50



Schliesskasten, links oder rechts verwendbar
1 + 2 für Elektrischer Türöffner
Gâche à encastrer, utilisable droite et gauche
1 + 2 pour gâche électrique
Striking box, left or right side usage
1 + 2 for electric door opener
Scatola di chiusura, utilizzo a sinistra o a destra
1 + 2 per apertura elettrica
Kilitleme kasaları, Sağ ve sol olarak kullanılabilir

B x H x T /mm	1 Best.-Nr.	2 Best.-Nr.	3 Best.-Nr.
45 x 172 x 30	1325-30	1326-30	1327-30
45 x 172 x 34	1325-34	1326-34	1327-34
45 x 172 x 40	1325-40	1326-40	1327-40

Schliessbleche / Platines de gâche Striking plates / Controbochetta / Kilit aynaları

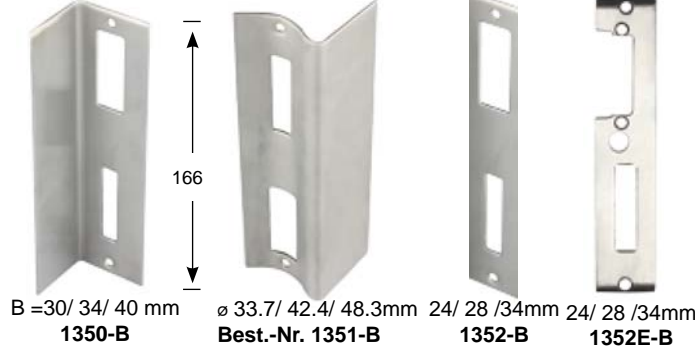

B = 30/ 34/ 40 mm
1350-B
ø 33.7/ 42.4/ 48.3mm
Best.-Nr. 1351-B
24/ 28 /34mm
1352-B
24/ 28 /34mm
1352E-B



Elektrischer Türöffner mit Entriegelung,
Links oder Rechts verwendbar
Gâche électrique avec levier de déblocage.,
Utilisable droite et gauche
Electric door opener with mechanical release.,
Left or right side usage
Apertura elettrica con meccanismo a rilascio
meccanico,
Utilizzo a sinistra o a destra
Elektrikli kapı açma otomatığı
Sağ ve sol olarak kullanılabilir

6-12V AC/DC,
67 x 16,5 x 28,5 mm

Best.-Nr. 10270

Design-Schlossgehäuse,
Links oder Rechts verwendbar, 2-tourig
Boîtier de serrure design ,
Disponible droite et gauche, à 2 tours.
Design lock case,
Left or right side usage with 2-tours lock.
Serratura design,
Utilizzabile sia a destra che a sinistra, scrocco a doppio giro.
Dizayn kilit kasası,
Sağ ve Sol olarak kullanılabilir, iki türlü kilit ile.

Anschluss "Rund" / Fixation pour barreau
"Round" connection Attacco speciale per incastro su tubi
Boruya montaj için

øD /mm	B x H x T /mm	Best.-Nr.
42,4	130 x 250 x 42,4	1301-42
48,3	130 x 250 x 48,3	1301-48

E = 72 mm, A = 60 mm

Design-Schlossgehäuse,
Links oder Rechts verwendbar, 2-tourig
Boîtier de serrure design ,
Disponible droite et gauche, à 2 tours.
Design lock case,
Left or right side usage with 2-tours lock.
Serratura design,
Utilizzabile sia a destra che a sinistra, scrocco a doppio giro.
Dizayn kilit kasası,
Sağ ve Sol olarak kullanılabilir, iki türlü kilit ile.

B x H x T /mm	Best.-Nr.
130 x 250 x 30	1302-30
130 x 250 x 34	1302-34
130 x 250 x 40	1302-40

E = 72 mm, A = 60 mm

Design-Gegenkasten,
Links oder Rechts verwendbar
Gâche design ,
Utilisable droite et gauche
Design striking case,
Left or right side usage
Controbocchetta design,
Utilizzo a sinistra o a destra
Dizayn karşılık kasası,
Sağ ve sol olarak kullanılabilir

Anschluss "Rund" / Fixation pour barreau
"Round" connection Attacco speciale per incastro su tubi
Boruya montaj için

øD /mm	B x H x T /mm	Best.-Nr.
42,4	130 x 250 x 42,4	1321-42
48,3	130 x 250 x 48,3	1321-48

Design-Gegenkasten,
Links oder Rechts verwendbar
Gâche design ,
Utilisable droite et gauche
Design striking case,
Left or right side usage
Controbocchetta design,
Utilizzo a sinistra o a destra
Dizayn karşılık kasası,
Sağ ve sol olarak kullanılabilir

B x H x T /mm	Best.-Nr.
130 x 250 x 30	1322-30
130 x 250 x 34	1322-34
130 x 250 x 40	1322-40

Torriegel für Hangschloss
Verrou au sol pour porte / Door bolt
Chiavistello / Kapı Sürgüsü

L /mm	B /mm	A /mm	s /mm	Best.-Nr.
200	55	25	8	1360-200

AK INOX

New - Nuovo - Yeni

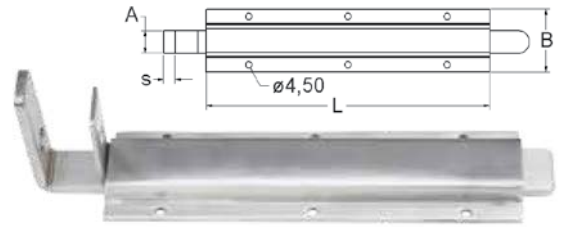

AK INOX Torbänder / Gonds / Hinges / Cerniere / Menteşeler

Torband verstellbar
Charnière réglable
Adjustable hinge
Cerniera regolabile
Ayarlı menteşe

øD /mm	L /mm	Best.-Nr.
M12	65	1390-12
M12	100	1390-12L
M16	65	1390-16
M20	65	1390-20

Torband zweiteilig
Charnière à souder
Weld-on hinge
Cerniera
Mil menteşe

øD x L /mm	Best.-Nr.
20 x 70	1391-20
24 x 85	1391-24

New - Nuovo - Yeni

Torband zweiteilig zur Verschraubung
Charnière à visser
Hinge to screw
Cerniera a vite
Vidalanan mil menteşe

øD x L /mm	Best.-Nr.
20 x 70	1392-20
24 x 85	1392-24

ø20 mm = M6
ø24 mm = M8

New - Nuovo - Yeni

Akbaz

Konkret & Metal Ürünleri



P & H Saffra GdbR, D - 91301 Forchheim



helu Maschinenbau GmbH & Co. KG, A - 6232 Münster



P & H Saffra GdbR, D - 91301 Forchheim

V2A / INOX 304



V2A / INOX 304

Türdrücker - Hohl / Poignées de porte - Creuses
Lever handles - Hollow / Maniglie - Vuote all'interno / Kapı kolları - içi boş



140 x 60 mm
Best.-Nr. 1700



140 x 60 mm
Best.-Nr. 1701

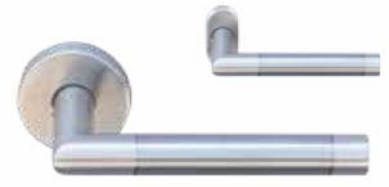

140 x 60 mm
Best.-Nr. 1701-SH



140 x 60 mm
Best.-Nr. 1702



140 x 60 mm
Best.-Nr. 1703



140 x 60 mm
Best.-Nr. 1704

AK INOX



Kartoninhalt
Zwei Türgriffe
Zwei Drücker-Rosetten
Zwei Schlüssel-Rosetten
Schrauben
Vierkantstift (8x100 mm)

Contenud'une boîte
Deux poignées
Deux rosettes de poignée
Deux rosettes de serrure
Vis
Branche quadrangulaire

Box contents
Two lever handles
Two handle rosettes
Two lock rosettes
Screws
Profile spindle

Contenuto della scatola
Due maniglie
Due rosette per maniglie
Due rosette per serratura
Viti
Barra di connessione

Kutu içeriği
İki kapı kolu
İki kol rozeti
İki kilit rozeti
Vidalar
Kapı kolu pimi



140 x 60 mm
Best.-Nr. 1707



140 x 60 mm
Best.-Nr. 1712



140 x 60 mm
Best.-Nr. 1713



140 x 60 mm
Best.-Nr. 1714



140 x 60 mm
Best.-Nr. 1715



140 x 60 mm
Best.-Nr. 1716

AK INOX

Türdrücker - Massiv / Poignées de porte - Pleines
Lever handles - Solid / Maniglie massicce / Kapı kolları - içi dolu



140 x 60 mm
Best.-Nr. 1707



140 x 60 mm
Best.-Nr. 1708



140 x 60 mm
Best.-Nr. 1709

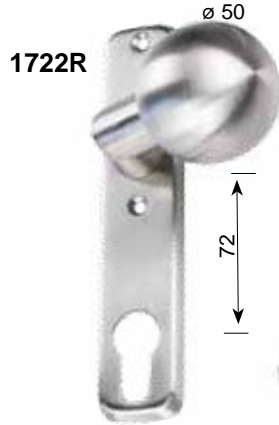

Fest / Fixe / Fixed / Fisso / Sabit

Best.-Nr.
1720

Best.-Nr.
1722R Rechts / a droite / right / a destra
1722L Links / a gauche / left / a sinistra

KS = 155 x 32 mm

Drehbar / Pivotante / Turnable / Girevole / Çevrilebilir

Best.-Nr.
1721

Best.-Nr.
1723

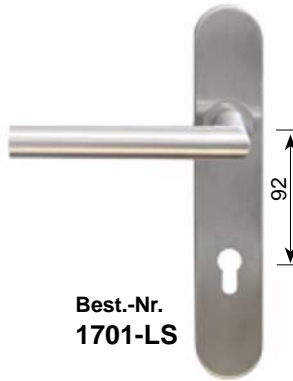

Fest / Fixe / Fixed / Fisso / Sabit

Best.-Nr.
1724

Best.-Nr.
1725

Best.-Nr.
1727

Best.-Nr.
1728

Best.-Nr.
1729

Drehbar / Pivotante / Turnable / Girevole / Çevrilebilir

Best.-Nr.
1724-D

Best.-Nr.
1725-D

Best.-Nr.
1727-D

Best.-Nr.
1728-D

Best.-Nr.
1729-D

E-mail: bilgi@yapimetal.net, www.yapimetal.net

Telefon: (312) 385 48 06 - Belgegeçer: (312) 385 42 16



87 x 37 x 37 mm

Best.-Nr.
1710

Massiv / Pleines
Solid / Massicce / içi dolu
Drehbar / Pivotante
Turnable / Girevole / Çevrilebilir

Paar/Set = 2 x



87 x 37 x 37 mm

Best.-Nr.
1711



ø 55 mm
Best.-Nr.
1750-FU



ø 55 mm
Best.-Nr.
1750-PZ



ø 55 mm
Best.-Nr.
1750-BB



ø 55 mm
Best.-Nr.
1750-B



26 x 65 mm
Best.-Nr.
1755-FU



26 x 65 mm
Best.-Nr.
1755-PZ



26 x 65 mm
Best.-Nr.
1755-BB



26 x 65 mm
Best.-Nr.
1755-B

AK INOX

Stossgriffe / Poignées fixes
Pull handles / Maniglioni / Çekme Kollar

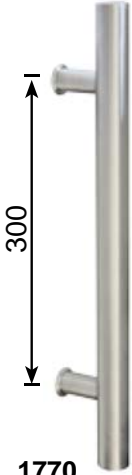

1770
ø 32 mm

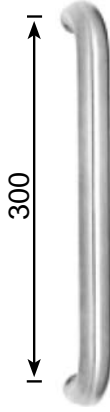

1771
ø 32 mm

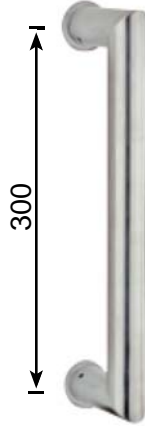

1771-EK
ø 32 mm

New - Yeni
Neues - Yeni

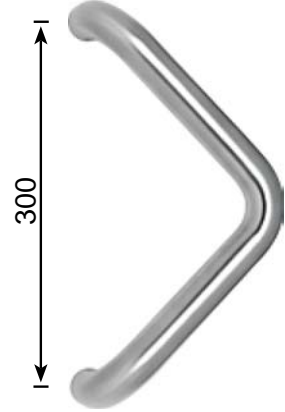

1774
ø 32 mm

Sonderabmessungen auf Anfrage / Dimensions spéciales sur demande
Special sizes of products on demand / Misure speciali su richiesta
Talep üzerine özel ölçülerde üretilebilir

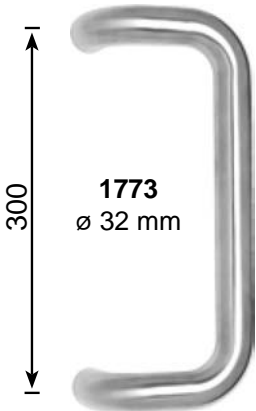

1773
ø 32 mm

0 1 2 3
4 5 6
7 8 9
a b c d

0,1,2,3,4,5,6,7,8,9
=150 mm
a,b,c,d = 115 mm
Best.-Nr.
1790

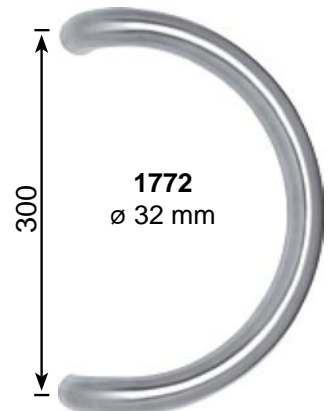

1772
ø 32 mm

Seilssystem und Zubehör / Fixations et accessoires nautiques
Wire rope and chain systems / Sistemi a fine e catena / Halat ve zincir sistemleri

Drahtseile / Cordages / Wire ropes / Funi / Halat

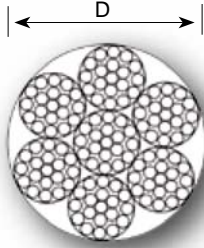

Drahtseil 7x19, 25 m-Rolle
 Cordage 7x19, 25 m-Bobine
 Wire rope 7x19, 25 m-Reel
 Fune 7x19, 25 m-Ruote
 Halat 7x19, 25 m Makara

V2A / Inox 304	
øD /mm	Best.-Nr.
3	1420-3-S 304
4	1420-4-S 304
5	1420-5-S 304

Ketten / Chaines / Chains / Catene / Zincir



Edelstahl V2A / Inox 304
 Inox 304 / Inox 304
 304 Kalite Paslanmaz Çelik
 DIN 766

V2A / Inox 304	
øD /mm	Best.-Nr.
3	1421-3-304
4	1421-4-304
5	1421-5-304
6	1421-6-304

Gewindeterminale für Selbstmontage

Embout à filetage externe

Self mounting terminal with external thread

Terminali automontanti con filettatura esterna

Saplamalı terminal (setskur sıkıştırılmalı)



Rechtsgewinde Filetage droite Right thread Filetto destro Sağ dişli	øD /mm	øD1 /mm	L /mm	M x l /mm	Best.-Nr.
	2	7,85	50	4x20	1461-8
	3	9,7	56	4x20	1461-10
	4	12	65	5x24	1461-12

Linksgewinde Filetage gauche Left thread Filetto sinistro Sol dişli	øD /mm	øD1 /mm	L /mm	M x l /mm	Best.-Nr.
	2	7,85	50	4x20	1461-8-L
	3	9,7	56	4x20	1461-10-L
	4	12	65	5x24	1461-12-L

Innengewindeterminale für Selbstmontage

Embout à filetage interne

Self mounting terminal with internal thread

Terminali automontanti con filettatura interna

Yuvalı terminal (setskur sıkıştırılmalı)

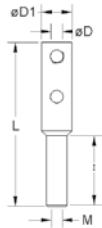

Rechtsgewinde Filetage droite Right thread Filetto destro Sağ dişli	øD /mm	øD1 /mm	L /mm	M x l /mm	Best.-Nr.
	2	8	50	4x20	1460-2
	3	10	56	4x20	1460-3
	4	12	65	5x25	1460-4

Linksgewinde Filetage gauche Left thread Filetto sinistro Sol dişli	øD /mm	øD1 /mm	L /mm	M x l /mm	Best.-Nr.
	2	8	50	4x20	1460-2-L
	3	10	56	4x20	1460-3-L
	4	12	65	5x25	1460-4-L

Augterminale für Selbstmontage

Embout à chape, fixation interne

Self mounting fork terminal

Terminali a forcilla automontanti

Çatalı terminal (setskur sıkıştırılmalı)

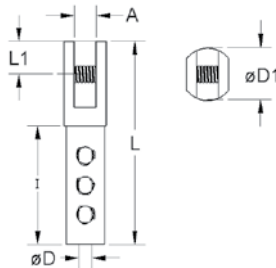

øD /mm	øD1 /mm	L /mm	l /mm	L1 /mm	A /mm	Best.-Nr.
2	10	44	24,5	7,0	4,7	1433-S-2
3	12	57	32,0	7,5	5,0	1433-S-3
4	16	60	35,0	8,0	7,0	1433-S-4

Gabelterminale für Selbstmontage

Embout à chape avec oeil

Self mounting terminal with eye

Terminali automontanti con occhio

Gözlü terminal (setskur sıkıştırılmalı)

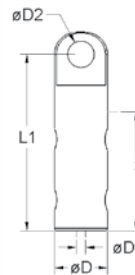

øD /mm	øD1 /mm	øD2 /mm	L1 /mm	l /mm	Best.-Nr.
2	2,4	4,5	37	25	1430-S-2
3	3,5	5,5	43	32	1430-S-3
4	4,5	6,5	52	34	1430-S-4

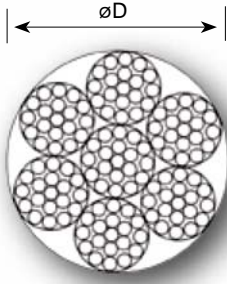

**Bu ürünlerin
Türkiye'de
satışı yoktur!**

Drahtseil 7x19, 25 m-Rolle
 Cordage 7x19, 25 m-Bobine
 Wire rope 7x19, 25 m-Reel
 Fune 7x19, 25 m-Ruote
 Halat 7x19, 25 m Makara

V4A / Inox 316	
øD /mm	Best.-Nr.
3	3420-3
4	3420-4
5	3420-5

Spannhülse / Cage fermée de ridoir
 Body of turnbuckle / Tenditori corpo / Gerdirme gövdesi



M	Best.-Nr.
M5	3425-5
M6	3425-6
M8	3425-8
M10	3425-10

Gewindeösenterminal / Boulon à oeil
 Eye bolt / Vite lunga con occhiello / Gözlü saplama



M	Best.-Nr.
M5	3437-5
M6	3437-6
M8	3437-8
M10	3437-10

Spannschloss mit Haken-Öse
 Ridoir à crochet-oeil / Turnbuckle with Hook-Eye
 Tenditore uncino-occhiello / Göz-Kanca gerdirme

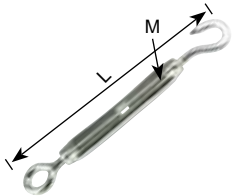

L /mm	M	Best.-Nr.
172-252	M6	3418-HE-6
182-257	M8	3418-HE-8
213-298	M10	3418-HE-10
238-318	M12	3418-HE-12

Gabelterminal / Embout à chape
 Fork terminal / Terminale a forcella / Çatal terminal



øD /mm	Best.-Nr.
3	3431-3
4	3431-4
5	3431-5
6	3431-6

Spannschloss mit Haken/Haken
 Ridoir à deux crochets / Turnbuckle with Hook-Hook
 Tenditore a doppio uncino / Kanca-Kanca gerdirme



L /mm	M	Best.-Nr.
160	M6	3418-HH-6
200	M8	3418-HH-8
240	M10	3418-HH-10
300	M12	3418-HH-12

Spannschloss mit Öse/Öse
 Ridoir à deux yeux / Turnbuckle with Eye-Eye
 Tenditore a doppio occhiello / Göz-Göz gerdirme



L /mm	M	Best.-Nr.
160	M6	3418-EE-6
200	M8	3418-EE-8
240	M10	3418-EE-10
300	M12	3418-EE-12

Wantenspanner mit 2 Gabeln
 Ridoir à chapes fixes / Turnbuckle with two forks
 Tenditore a doppia forcella / Liftin



L /mm	M	Best.-Nr.
144	M6	3423-6
173	M8	3423-8
207	M10	3423-10
251	M12	3423-12

Gewindeterminal / Piton à sertir
 Swage stud / Terminale a perno / Saplamalı terminal



M	øD /mm	Best.-Nr.
M6	3	3439-6-3
M6	4	3439-6-4
M8	5	3439-8-5
M10	6	3439-10-6

Gabelterminal / Embout à chape
 Fork terminal / Terminale a forcella / Çatal terminal



øD /mm	Best.-Nr.
3	3433-3
4	3433-4
5	3433-5
6	3433-6

Gewindegabel / Embout à chape avec filetage externe
 Fork with external thread / Forcella con filetto esterno / Çatal saplama



øD /mm	Best.-Nr.
M5	3434-5
M6	3434-6
M8	3434-8
M10	3434-10

Gewindegabel

Embout à chape avec filetage externe / Fork with external thread
Forcella con filetto esterno / Çatal saplama

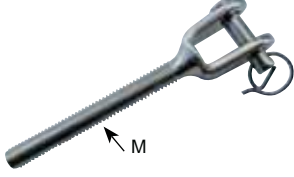

M	Best.-Nr.
M5	3432-5
M6	3432-6
M8	3432-8
M10	3432-10

Augterminal für Selbmontage

Embout à chape, fixation interne / Self mounting fork terminal
Terminali a forcella automontanti / Çatal terminal (setskur sıkıştırılmalı)



øD /mm	Best.-Nr.
2	3433-S-2
3	3433-S-3
4	3433-S-4

Augterminal

Embout à oeil à sertir / Eye bolt terminal
Bullone con terminale a occhiello / Gözlü terminal



øD /mm	Best.-Nr.
3	3436-3
4	3436-4
5	3436-5
6	3436-6

Augbolzen

Boulon à oeil avec écrou / Eye bolt with cap
Vite lunga con occhiello e rondelle / Gözlü saplama (şapkalı)

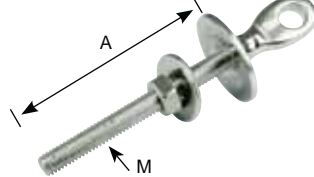

M	A /mm	Best.-Nr.
M6	60	3438-6
M8	80	3438-8

Linsenkopfterminal / Terminaison à tête cylindrique bombée à sertir /
Domed head terminal / Terminale a testa cilindrica
Kubbe baş terminal



øD /mm	Best.-Nr.
3	3440-3
4	3440-4
5	3440-5
6	3440-6

Augenschraube / Piton à oeil

Eye bolt / Terminale a occhiello / Gözlü saplama

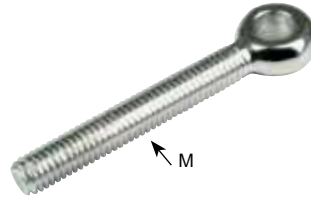

M	Best.-Nr.
M6	3491-2-6
M8	3491-2-8
M10	3491-2-10

Wantenspanner mit Gabel/Gewinde

Ridoir à chape fixe, terminaison à sertir
Turnbuckle with fork and terminal
Tenditore con terminale a forcella / Terminallı liftin

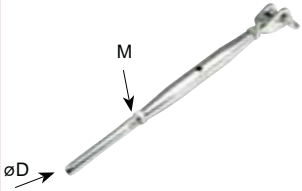

M	øD /mm	Best.-Nr.
M6	3	3424-6
M8	4	3424-8
M10	5	3424-10
M12	6	3424-12

Augenschraube mit Holzgewinde

Piton à oeil fermé filetage bois / Eye bolt with wood thread
Bullone con occhiello con filetto da legno / Ağaç için gözlü saplama

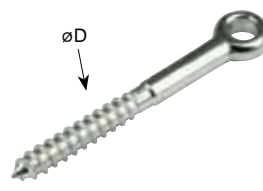

øD /mm	Best.-Nr.
M6	3491-1-6
M8	3491-1-8
M10	3491-1-10

Gabelterminal für Selbmontage / Embout à chape avec oeil
Self mounting terminal with eye / Terminali automontanti con occhiello
Gözlü terminal (setskur sıkıştırılmalı)



øD /mm	Best.-Nr.
2	3435-4
3	3435-5
4	3435-6
5	3435-8
6	3435-10

Innengewindeterminale für Selbstmontage / Embout à filetage interne

Self mounting terminal with internal thread
Terminali automontanti con filettatura interna
Yuvalı terminal (setskur sıkıştırılmalı)



M	øD /mm	Best.-Nr.
M4	2	3460-2
M4	3	3460-3
M5	4	3460-4

Gewindeterminale für Selbmontage / Embout à filetage externe

Self mounting terminal with external thread
Terminali automontanti con filettatura esterna
Saplamalı terminal (setskur sıkıştırılmalı)



øD /mm	Best.-Nr.
2	3461-8
3	3461-10
4	3461-12

Gabelterminal für Selbmontage / Embout à chape avec oeil

Self mounting terminal with eye
Terminali automontanti con occhiello
Gözlü terminal (setskur sıkıştırılmalı)



øD /mm	Best.-Nr.
2	3430-S-2
3	3430-S-3
4	3430-S-4

AK INOX

Ketten und Zubehör / Chaînes et équipements
Chains and accessories / Catene e accessori / Zincir ve aksesuarları

**Bu ürünlerin
Türkiye'de
satışı yoktur!**

Abbildung in Edelstahl



Edelstahl V4A / Inox 316
 Inox 316 / Inox 316
 316 kalite paslanmaz çelik
 DIN 766

øD /mm	Best.-Nr.
3	3421-3
4	3421-4
5	3421-5
6	3421-6

Stahl verzinkt / Acier zingué
 Galvanized steel / Acciaio zincato
 Galvanizli çelik
 DIN 766

øD /mm	Best.-Nr.
3	1421-Z-3
4	1421-Z-4
5	1421-Z-5
6	1421-Z-6

Schäkel / Manille droite

Shackle (D type) / Grillo (tipo D) / Zincir kilidi (D tipi)



øD /mm	Best.-Nr.
4	3401-4
5	3401-5
6	3401-6
8	3401-8

Flachschäkel (lange Form) / Manille droite plate, longue

Flat shackle (long D type) / Grillo piatto (tipo D lungo)
 Zincir kilidi (uzun düz D tipi)



øD /mm	Best.-Nr.
4	3410-4
5	3410-5
6	3410-6
8	3410-8

Schäkel / Manille lyre

Shackle (omega type) / Grillo (tipo omega) / Zincir kilidi (omega tipi)



øD /mm	Best.-Nr.
4	3402-4
5	3402-5
6	3402-6
8	3402-8

Schlüsselschäkel mit Steg

Manille droite longue avec barette, axe imperdable
 Key-pin shackle with bar / Grillo con chiave a perno con barra
 Anahtarlı zincir kilidi (gözlü D tipi)



øD /mm	Best.-Nr.
5	3411-5
6	3411-6
8	3411-8

Rundschäkel (lange Form) / Manille droite, longue

Shackle (long D type) / Grillo (tipo D lungo) / Zincir kilidi (uzun D tipi)



øD /mm	Best.-Nr.
4	3403-4
5	3403-5
6	3403-6
8	3403-8

Rundschäkel (gedrehte Form) / Manille torse

Shackle (twisted type) / Grillo (tipo arrotolato) / Zincir kilidi (burgulu tip)



øD /mm	Best.-Nr.
5	3412-5
6	3412-6
8	3412-8

AK INOX

V4A / INOX 316

Klemmbefestigungen / Pinces de vitre

Glass clamps / Supporti a clip per vetro / Cam tutucuları

Seite/ Page

Page / Pagina / Sayfa

12-13



Rundschäkel (gedrehte Form)
Manille torse / Shackle (twisted type)
Grillo (tipo arrotolato) / Zincir kilidi (burgulu tip)



øD /mm	Best.-Nr.
4	3404-4
5	3404-5
6	3404-6
8	3404-8

Flachschäkel (lange Form) / Manille droite plate, longue
Flat shackle (long D type) / Grillo piatto (tipo D lungo)
Zincir kilidi (uzun düz D tipi)



øD /mm	Best.-Nr.
6	3414-6
8	3414-8

Flachschäkel (geschweifte Form) / Manille lyre plate
Flat shackle (omega type) / Grillo piatto (tipo omega)
Zincir kilidi (düz omega tipi)



øD /mm	Best.-Nr.
4	3409-4
5	3409-5
6	3409-6
8	3409-8

Augenschraube mit Ring / Piton à anneau
Eye bolt with ring / Bullone con anello / Halkalı vida



A /mm	Best.-Nr.
3	3492-3
5	3492-5

Ringmutter / Ecrou à anneau
Lifting eye nut / Anello filettato / Halkalı somun



M	Best.-Nr.
M6	3489-6
M8	3489-8
M10	3489-10

Seilkausche / Cosse cœur
Wire thimble / Redancia per fune / Radanza



øD /mm	Best.-Nr.
3	3455-3
4	3455-4
5	3455-5
6	3455-6

Ringschraube / Vis à anneau
Lifting eye bolt / Vite ad anello / Halkalı civata



M	Best.-Nr.
M6	3490-6
M8	3490-8
M10	3490-10

Simplexklemme / Serre câble plat
Simplex wire rope clip / Fermacavo piatto / Tekli klemens



øD /mm	Best.-Nr.
3	3448-3
4	3448-4
5	3448-5
6	3448-6

Kettenschnellverschluss / Crochet avec écrou
Hook with nut / Moschettone con dado / Vida kilitli karabina



øD /mm	Best.-Nr.
4	3482-4
5	3482-5
6	3482-6
8	3482-8

Duplexklemme / Double serre câble plat
Duplex wire rope clips / Doppio fermacavo piatto / Çiftli klemens



øD /mm	Best.-Nr.
3	3449-3
4	3449-4
5	3449-5
6	3449-6

Karabinerhaken / Mousqueton
Snap hook / Moschettone / Karabina



D x L /mm	Best.-Nr.
4 x 40	3465-4
5 x 50	3465-5
6 x 60	3465-6
8 x 80	3465-8

Seilklemme / Serre câble à étrier
Wire rope clip / Fermacavo / Halat klemensi (kerye)



øD /mm	Best.-Nr.
3	3441-3
4	3441-4
5	3441-5
6	3441-6