

Akhis

Korkuluk & Metal Ürünleri

Paslanmaz Çelik Aksesuarlar



Paslanmaz Çelik Patent Dirsekler

Paslanmaz Çelik Borular



Bu broşürde gördüğünüz ürünlerimiz, ürettiklerimizin sadece bir kısmıdır. Detaylı kataloğumuzu web sayfamızdan inceleyebilirsiniz.

Ecoline Serisi

Yeni
ecoline
serisi

KÜRE VE KÜRE YÜZÜKLER

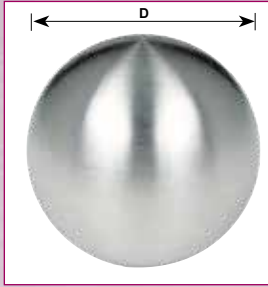

3 mm
Montaj
Deligi ile

KÜRE	
øD mm	Ürün Kodu
40	1045-40-E



304
Kalite

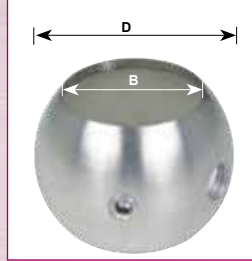

KÜRE YÜZÜK BORU TUTUCU		
øB mm	øD mm	Ürün Kodu
26,9	40	1058-27-E
32	45	1058-32-E
48,3	60	1058-48-E
50,8	60	1058-51-E

“ecoline”



Uygun
Fiyat

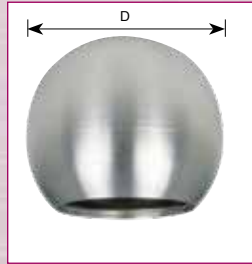

KÜRE KAPAK		
øB mm	ø D mm	Ürün Kodu
26,9	40	1046-27-E
32	45	1046-32-E
48,3	60	1046-48-E
50,8	60	1046-51-E



“ecoline”



TOPUZ		
Kullanıldığı Boru		Ürün Kodu
Çap	Et Kalınlığı	
32	1,5	1048-32-E
42,4	2,0	1048-42-E

BORU KAPAKLARI

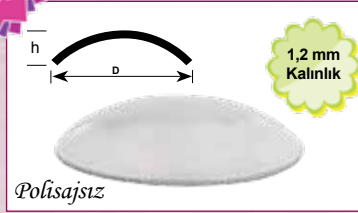

1,2 mm
Kalınlık

Polısajsız

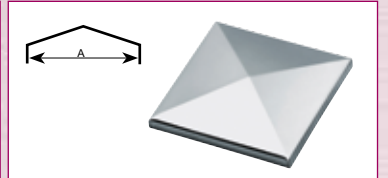

PROFİL KAPAĞI	
A / mm	Ürün Kodu
30 x 30	1660-3030
30 x 40	1660-3040
40 x 40	1660-4040
50 x 50	1660-5050
60 x 60	1660-6060
80 x 80	1660-8080

OVAL BORU KAPAĞI		
øD mm	h mm	Ürün Kodu
16	4	1200-16-E
42,4	9	1200-42-E
50,8	10	1200-51-E



Ürün Kodu 1009-xx-E



Ürün Kodu 1009-xx-G

BORU KAPAĞI-İÇE GEÇME		
Kullanıldığı Boru		Ürün Kodu
Çap mm	Et Kalınlığı mm	
12	1,2	1009-1212
16	1,5	1009-1615
32	1,5	1009-3215
32	1,5	1009-3215-G
50,8	1,5	1009-51-E



“ecoline”



BORU KAPAĞI-ÜSTE GEÇME	
Boru Çapı	Ürün Kodu
16	1018-16-E
42,4	1018-42-E
48,3	1018-48-E
50,8	1018-51-E



Ürün Kodu
25100

Alman Devi WS-Plast'tan
Emsalsiz Ürün!

**Paslanmaz Çelik
Yüzey Temizleme ve
Bakım Spreyi**

Mat ve parlak paslanmaz çelik yüzeyleri temizlemek amacıyla kullanılır. Parmak izi ve yağ lekeleri kolayca çıkarır. Yüzeyde yeniden kirlenmeye karşı ince bir koruyucu film tabakası bırakır.
Alo Sipariş 0312 385 48 06

AK INOX



KÜPEŞTE MAFSALLAR

KÜPEŞTE MAFSAL TAKIMI

Kullanıldığı Dikme Borusu-øB	Ürün Kodu
32 mm	1267-32-E
38 mm	1267-38-E
42,4 mm	1267-42-E
32 mm	1267-32-O-E
38 mm	1267-38-O-E
42,4 mm	1267-42-O-E

Küpeşte Mafsalları, küpeşte ayağı ve dikme boru şapkasından oluşur. Montaj pulu ve vidaları takıma dahil değildir.

MAFSAL MONTAJ PULU

Kullanıldığı Dikme Borusu	Malzeme	Ürün Kodu
32 mm	Paslanmaz Çelik	1267-MP-32
	Galvanizli Çelik	1267-VMP-32
38 mm	Paslanmaz Çelik	1267-MP-38
	Galvanizli Çelik	1267-VMP-38
42,4 mm	Paslanmaz Çelik	1267-MP-42
	Galvanizli Çelik	1267-VMP-42
M6x30 Vida	Paslanmaz Çelik	S7991-6-30
	Galvanizli Çelik	V7991-6-30

Küpeşte mafsalları montaj vidaları tercihli, paslanmaz çelik veya galvanizli çelik olarak kullanılmaya bırakılmıştır. Pulu ve vidaları kullanıldığında paslanmaz çelik ürünler tavsiye edilir.

KÜPEŞTE MONTAJ KOL VE ÇUBUKLARI

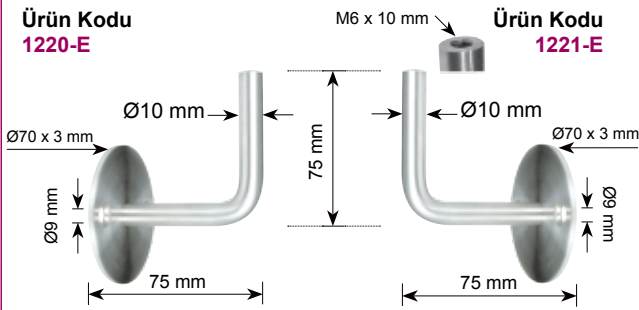

MONTAJ KOLU

Ürün Kodu
1220-E
1221-E
1229-G-E

KÜPEŞTE MONTAJ TABLASI

øD mm	Ürün Kodu
32-34	1280
38-43	1281
48-51	1282

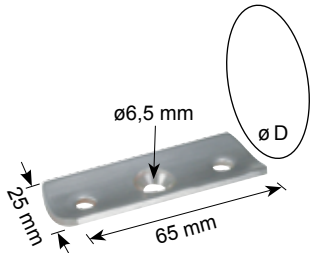

Örnek Uygulamalar

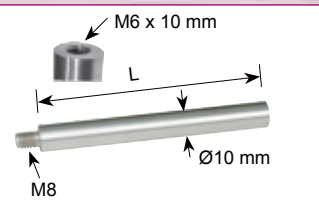

MONTAJ ÇUBUĞU

L / mm	Ürün Kodu
65	1292-E
100	1293-E

ÇUBUK TUTUCULAR

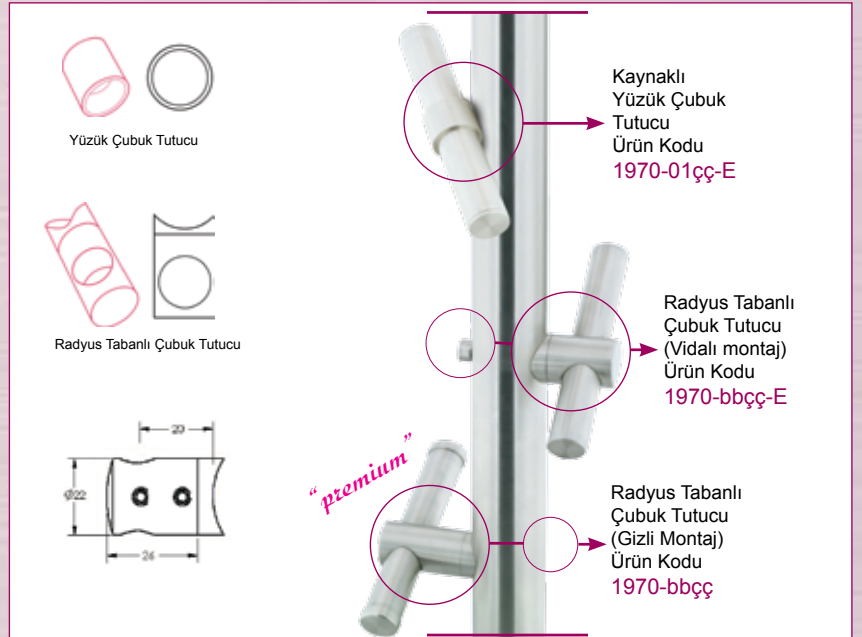

bb: Boru ölçüsü - çç: Çubuk ölçüsü

Montaj Edildiği Boru/mm	Kullanıldığı Çubuk / mm	Ürün Kodu
Tüm Borular	ø 12	1970-0112-E
Tüm Borular	ø 16	1970-0116-E
ø 32-34	ø 12	1970-3312-E
ø 32-34	ø 16	1970-3316-E
ø 38-43	ø 12	1970-4212-E
ø 38-43	ø 16	1970-4216-E
ø 32-34	ø 12	1970-3312
ø 32-34	ø 16	1970-3316
ø 38-43	ø 12	1970-4212
ø 38-43	ø 16	1970-4216

CAM TUTUCULAR

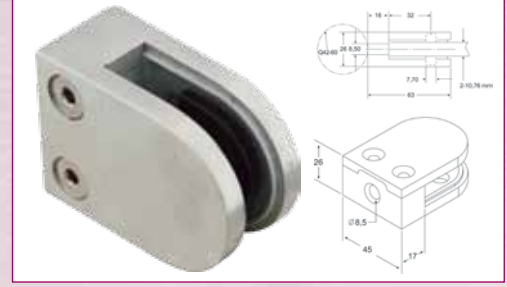
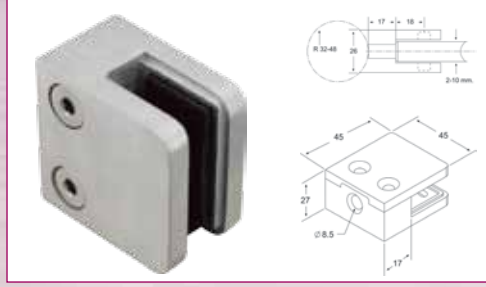
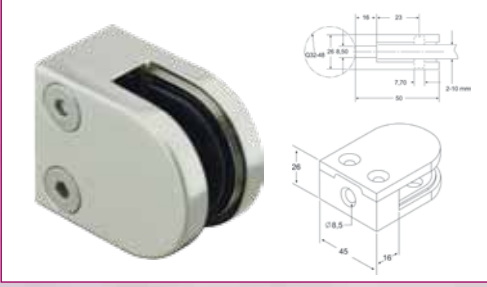

Form-1		
Yüzey	Taban	Ürün Kodu
Zamak	Düz	1811-G
	ø32-34	1811-R32
	ø38-43	1811-R42
	ø48-51	1811-R48
Inoks Görünüm	Düz	1819-G
	ø32-34	1819-R32
	ø38-43	1819-R42
	ø48-51	1819-R48
Inoks 304	Düz	1841-G
	ø32-34	1841-R32
	ø38-43	1841-R42
	ø48-51	1841-R48

Form-2		
Yüzey	Taban	Ürün Kodu
Zamak	Düz	1821-G
	ø32-34	1821-R32
	ø38-43	1821-R42
	ø48-51	1821-R48
Inoks Görünüm	Düz	1829-G
	ø32-34	1829-R32
	ø38-43	1829-R42
	ø48-51	1829-R48
Inoks 304	Düz	1851-G
	ø32-34	1851-R32
	ø38-43	1851-R42
	ø48-51	1851-R48

Form-3		
Yüzey	Taban	Ürün Kodu
Zamak	Düz	1831-G
	ø32-34	1831-R32
	ø38-43	1831-R42
	ø48-51	1831-R48
Inoks Görünüm	Düz	1839-G
	ø32-34	1839-R32
	ø38-43	1839-R42
	ø48-51	1839-R48
Inoks 304	Düz	1861-G
	ø32-34	1861-R32
	ø38-43	1861-R42
	ø48-51	1861-R48

Ürün Kodu 1712571

İsviçre'den **Rozet montajlarınızda MUNGO'nun boşluk dolduran yüksek kaliteli Poliüretan yapıştırıcısını deneyiniz !..**

Detaylı bilgi Yardımcı Malzemeler sayfasında...

ROZETLER

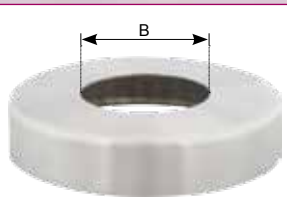

ROZET	Ø105X22 mm
Boru B/mm	Ürün Kodu
32	1216-32-E
33,7	1216-34-E
42,4	1216-42-E
48,3	1216-48-E
50,8	1216-51-E

ROZET	Ø75X12 mm
Boru B/mm	Ürün Kodu
12	1206-12-E
16	1206-16-E
32	1206-32-E
38	1206-38-E
42,4	1206-42-E

ROZET	Ø75X22 mm
Boru B/mm	Ürün Kodu
32	1210-32-E
33,7	1210-33-E
38	1210-38-E
42,4	1210-42-E
48,3	1210-48-E

ROZET	Ø75X24 mm
Boru B/mm	Ürün Kodu
12	1201-12-E
16	1201-16-E
32	1201-32-E
33,7	1201-34-E
38	1201-38-E

ROZET	Ø67X12 mm
Boru B/mm	Ürün Kodu
10	1205-10-E
32	1205-32-E
38	1205-38-E
42,4	1205-42-E
50,8	1205-51-E

AK INOX

MONTAJ PULLARI

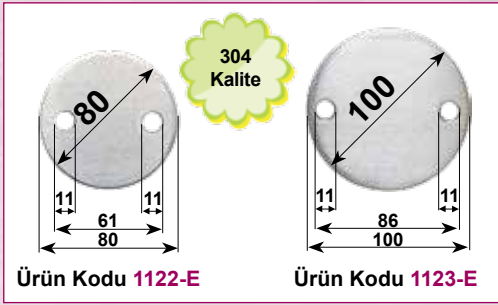

D x s / mm	Ürün Kodu
80 x 4	1122-E
100 x 4	1123-E
70 x 3	1130-E
80 x 4	1131-32-E
100 x 4	1131-42-E

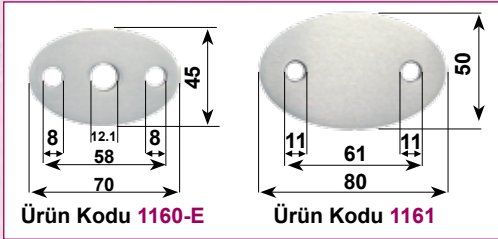
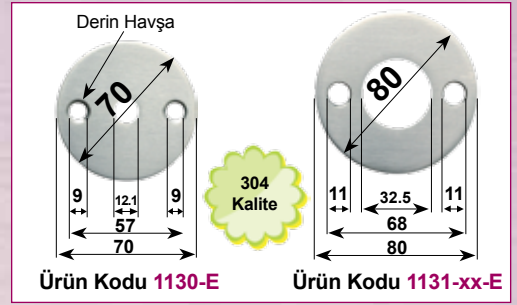

B x h x s / mm	Ürün Kodu
70 x 45 x 3	1160-E
80 x 50 x 4	1161
100 x 50 x 4	1140-E
120 x 60 x 4	1141

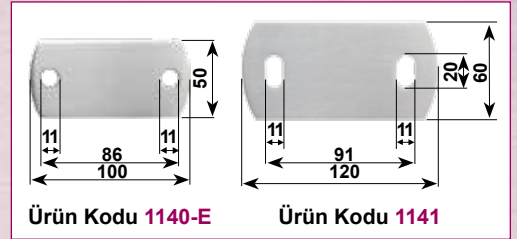

AK INOX

ANKRAJ MALZEMELERİ

Dikkat! Uygulama yerlerinde montaj puluna kaynak yapmak zor iştir. Sizde AKBAŞ Montaj çözümleri kullanın, işinizi kolaylaştırın.

Dikme borularının mukavemetini arttırmak için tavsiyemiz ankraj montaj altlıkları



Paslanmaz Çelik Ankraj Saplama
Ürün Kodu **S975-M12**



Paslanmaz Çelik Vidalı Çözüm
Ürün Kodu **1170-xx**



Paslanmaz Çelik Montaj Çözümü
Ürün Kodu **1171-xx**

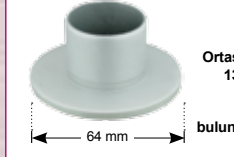

Galvanizli Çelik Montaj Çözümü
Ürün Kodu **1171-V**



Galvanizli Çelik Ankraj Saplama
Ürün Kodu **V975-M12**



Boru Kanalı
Paslanmaz Çelik Ankraj Pulü
Ürün Kodu **1172-xx**



Paslanmaz Çelik Ankraj Somunu
Ürün Kodu **S934-M12**

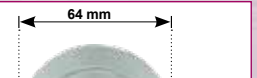
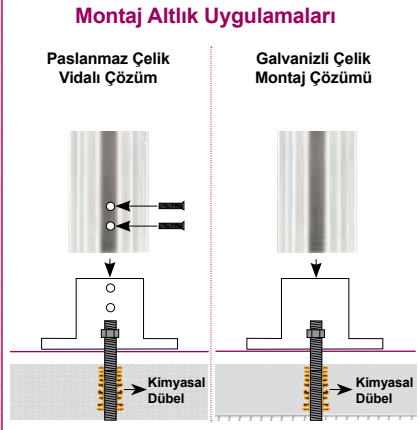

Boru Kanalı
Galvanizli Çelik Ankraj Pulü
Ürün Kodu **1172-xx-V**



Galvanizli Çelik Ankraj Somunu
Ürün Kodu **V934-M12**

Beton ve tuğla içi montajlarınızda tavsiyemiz MUNGO kimyasal dübelleri !..

Ürün Kodu **1710028**



Uygulamalarda en iyi sonuç MUNGO Kartuş, Dübel ve Elekleri ile birlikte elde edilmektedir.

ZEMİN PULLARI

AK INOX

Yeni Ürün

- Ürün Özellikleri**
1. Tırnaklı iç katmanı sayesinde boruya tam oturarak kayma yapmaz.
 2. Kolay kaynak yapma özelliği ile zamanınız boşa gitmez.
 3. Sağlam ve düzgün bir montaj imkanı sağlar.



D x s / mm	Ürün Kodu
70 x 4	1128-32-E
100 x 4	1128-43-E
100 x 4	1128-51-E

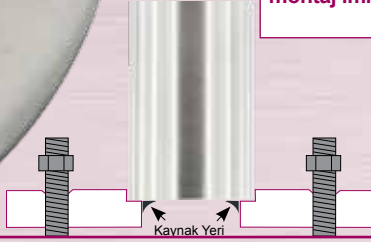

Pul ve Aksesuar montajlarında DIN normlu MUNGO çelik dübellerini deneyiniz !..

İsviçre'den ithal

Galvanizli Çelik Dübelleri

316 Kalite Paslanmaz Çelik Dübelleri

Tuğla Montaj Uygulamalarında İdeal

Kimyasal Dübel Elekləri



DİKME MONTAJ AKSESUARLARI

AK INOX

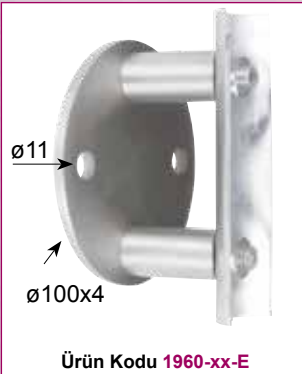

Boru mm	Ürün Kodu
32	1960-32-E
38	1960-38-E
42,4	1960-42-E
32	1961-32-E
38	1961-38-E
42,4	1961-42-E

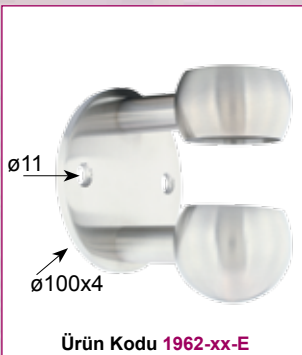
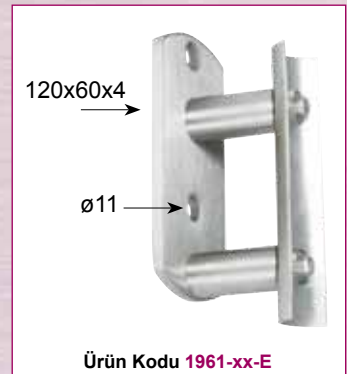

Boru mm	Ürün Kodu
32	1962-32-E
38	1962-38-E
42,4	1962-42-E
32	1963-32-E
38	1963-38-E
42,4	1963-42-E

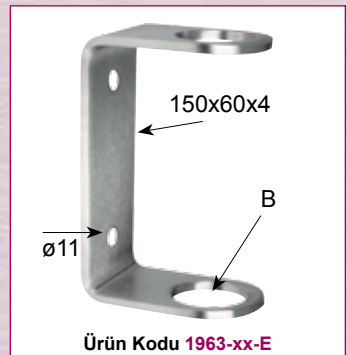

"ecoline"

AK INOX



Gerçek 304 Kalite ve Et Kalınlıklarında Patent Dirseklerimiz...

Dirsek Ölçüsü / mm	Polisaj	Yaklaşık Ağırlık	Ürün Kodu
32 x 1,5	Satineli	60 gram	1924-0320x15-SP
32 x 1,5	Parlak	60 gram	1924-0320x15-HP
42,4 x 2,0	Ham	154 gram	1924-0420x20-NP
42,4 x 2,0	Satineli	150 gram	1924-0420x20-SP
48,3 x 1,5	Satineli	152 gram	1924-0480x15-SP
48,3 x 2,0	Satineli	205 gram	1924-0480x20-SP
50,8 x 1,5	Ham	175 gram	1924-0508x15-NP
50,8 x 1,5	Satineli	166 gram	1924-0508x15-SP
50,8 x 1,5	Parlak	165 gram	1924-0508x15-HP

PASLANMAZ ÇELİK PATENT DİRSEK



PASLANMAZ ÇELİK BORU

Boru Ölçüsü Çap ve Et kalınlığı / mm	Polisaj	Kaynak Tipi	Ürün Kodu
12 x 1,0	Fırçalı	HF	T-0120x10-HBP
12 x 1,2	Fırçalı	HF	T-0120x12-HBP
12 x 1,5	Fırçalı	HF	T-0120x15-HBP
16 x 1,0	Fırçalı	HF	T-0160x10-HBP
16 x 1,2	Fırçalı	HF	T-0160x12-HBP
16 x 1,5	Fırçalı	HF	T-0160x15-HBP
16 x 2,0	Fırçalı	HF	T-0160x20-HBP
19 x 1,0	Fırçalı	HF	T-0190x10-HBP
20 x 1,5	Fırçalı	HF	T-0200x15-HBP
22 x 1,2	Fırçalı	HF	T-0220x12-HBP
32 x 1,2	Fırçalı	HF	T-0320x12-HBP
32 x 1,5	Fırçalı	HF	T-0320x15-HBP
32 x 1,5	Ham	TIG	T-0320x15-TNP
32 x 1,5	Parlak	TIG	T-0320x15-THP
33,7 x 1,2	Fırçalı	HF	T-0337x12-HBP
33,7 x 1,5	Fırçalı	HF	T-0337x15-HBP
33,7 x 2,0	Fırçalı	HF	T-0337x20-HBP
38 x 1,2	Fırçalı	HF	T-0380x12-HBP
38 x 1,5	Fırçalı	HF	T-0380x15-HBP
42,4 x 1,2	Fırçalı	HF	T-0424x12-HBP
42,4 x 1,5	Fırçalı	HF	T-0424x15-HBP
42,4 x 2,0	Fırçalı	HF	T-0424x20-HBP
48,3 x 1,2	Fırçalı	HF	T-0483x12-HBP
48,3 x 1,5	Fırçalı	HF	T-0483x15-HBP
48,3 x 2,0	Fırçalı	HF	T-0483x20-HBP
50,8 x 1,2	Fırçalı	HF	T-0508x12-HBP
50,8 x 1,5	Fırçalı	HF	T-0508x15-HBP
50,8 x 1,5	Ham	TIG	T-0508x15-TNP
50,8 x 1,5	Parlak	TIG	T-0508x15-THP
52,0 x 1,5	Fırçalı	HF	T-0520x15-HBP
60,3 x 1,2	Fırçalı	HF	T-0603x12-HBP
60,3 x 1,5	Fırçalı	HF	T-0603x15-HBP
76,1 x 1,5	Fırçalı	HF	T-0761x15-HBP
88,9 x 1,5	Fırçalı	HF	T-0889x15-HBP
88,9 x 2,0	Fırçalı	HF	T-0889x20-HBP
101,6 x 1,5	Fırçalı	HF	T-1016x15-HBP
101,6 x 2,0	Fırçalı	HF	T-1016x20-HBP
114,3 x 1,5	Fırçalı	HF	T-1143x15-HBP
114,3 x 3,0	Fırçalı	HF	T-1143x30-HBP



HF: Yüksek Frekans TIG: Argon



DİZAYN ÇUBUKLAR

AK INOX



Çubuk Sonlandırıcı Motif
ø 24 x 18 mm



Delik ø / mm	Ürün Kodu
10,2	1982-10
12,2	1982-12
14,2	1982-14
16	1982-16



Dizayn çubuklarımızın kolay montaj özelliği sayesinde kısa sürede kendi korkuluğunuzu oluşturun hem zamandan kazanın, hem paranız cebinizde kalsın...

AK INOX

ANADOLU MODELİ

AK INOX



Uygun Fiyatlı Model

MALZEME LİSTESİ

Sıra	Malzeme Adı
1	Küpeşte Borusu-42,4x1,5mm
2	Küpeşte Mafsal Takımı
3	Dikme Borusu-32x1,5mm
4	Yatay Boru-16x1,2mm
5	Üst Geçme Kapak
6	Rozet-67x12mm
7	Montaj Takımı

Not: Fiyatlarımız metretül malzeme olarak hesaplanmıştır Montaj hariçtir.

Çocuklarınızın güvenle tutunacakları korkuluklar için; korkuluk aralıklarını 12cm den daha fazla yapmayınız!

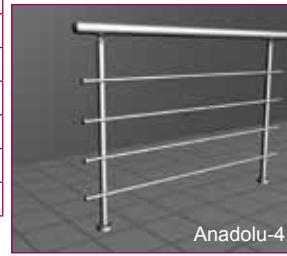

AK INOX

SİNOP MODELİ

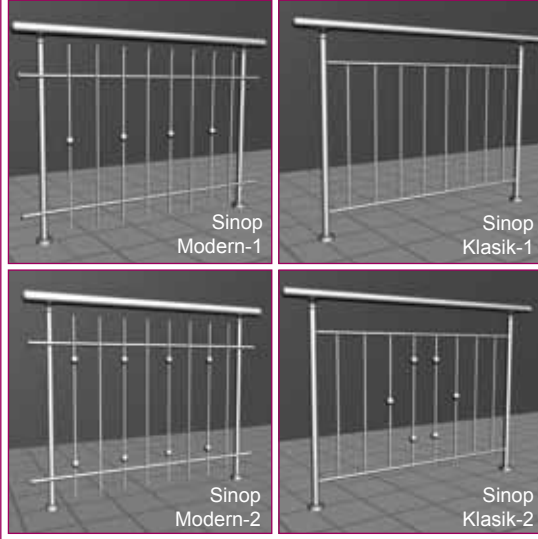

MALZEME LİSTESİ

Sıra	Malzeme Adı
1	Küpeşte Borusu-42,4x1,5mm
2	Küpeşte Mafsal Takımı
3	Dikme Borusu-32x1,5mm
4	Dikey Çubuklar
5	Boru Kapağı-Üste Geçme
6	Rozet-67x12mm
7	Montaj Takımı

Not: Fiyatlarımız metretül malzeme olarak hesaplanmıştır Montaj hariçtir.



Çocuklarınız için önerilen 12 cm aralıklarla

Sinop Klasik-1

AK INOX

ANTALYA MODELİ

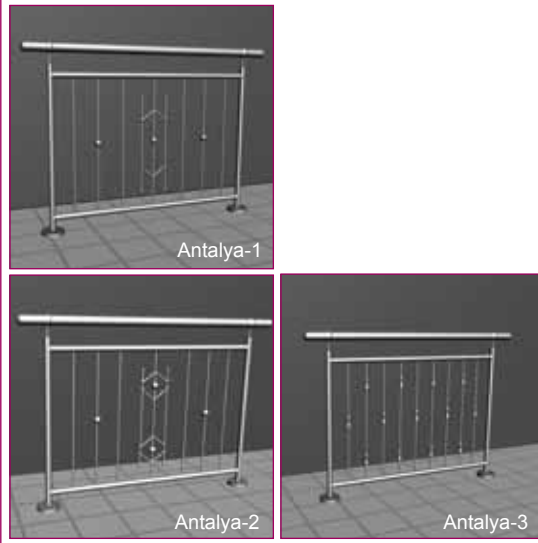

MALZEME LİSTESİ

Sıra	Malzeme Adı
1	Küpeşte Borusu-50,8x1,5mm
2	Küpeşte Mafsal Takımı
3	Dikme Borusu-32x1,5mm
4	Dikey Dizayn Çubuklar
5	Boru Kapağı-Üste Geçme
6	Rozet-67x12mm
7	Montaj Takımı

Not: Fiyatlarımız metretül malzeme olarak hesaplanmıştır Montaj hariçtir.

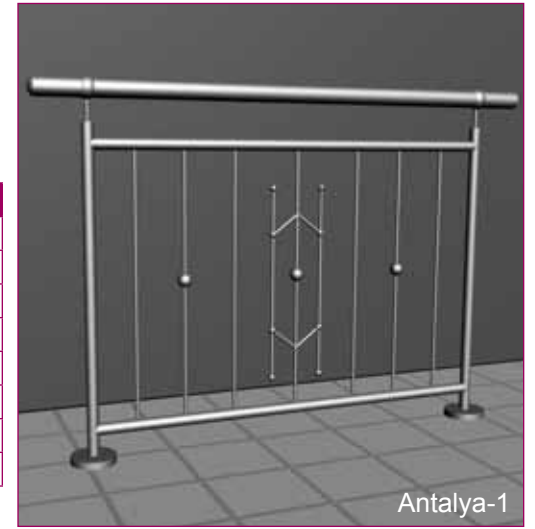

Antalya-1

AK INOX

GEMİ MODELİ (GERDİRME SİSTEMLİ)

Saplamalı Terminal (Setskur Sıkıştırılmalı)

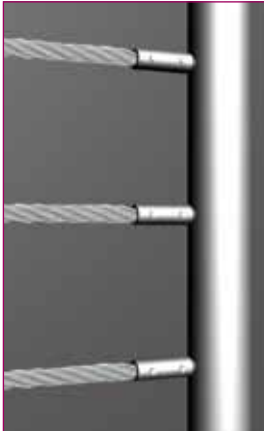

MALZEME LİSTESİ

Sıra	Malzeme Adı
1	Küpeşte Borusu-50,8x1,5mm
2	Küpeşte Mafsal Takımı
3	Dikme Borusu-42,4x1,5mm
4	Saplamalı Terminal
5	4 mm Pas. Çelik Halat (7x19)
6	Topuz
7	Rozet-67x12mm
8	Montaj Takımı

Not: Fiyatlarımız metretül malzeme olarak hesaplanmıştır Montaj hariçtir.

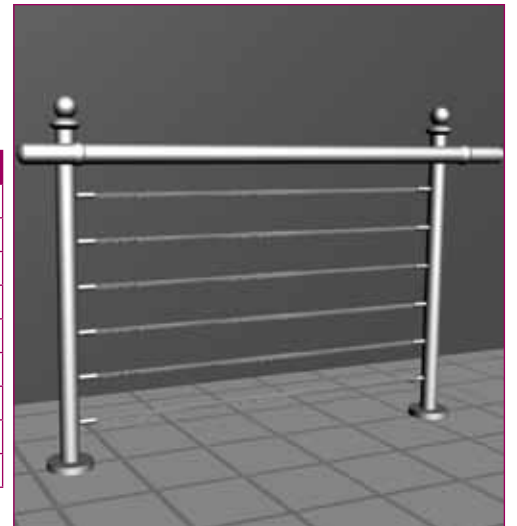

Kullanılan Tel	Ürün Kodu
2	1461-8
3	1461-10
4	1461-12

GAZİANTEP MODELİ

AK INOX



Gaziantep-1

MALZEME LİSTESİ

Sıra	Malzeme Adı
1	Küpeşte Borusu-50,8x1,5mm
2	Küpeşte Mafsallı Takımı
3	Dikme Borusu-32x1,5mm
4	Yatay Borular-16x1,2mm
5	Dikey Dizayn Çubuklar
6	Boru Kapakları
7	Rozet-67x12mm
8	Montaj Takımı

Not: Fiyatlarımız metrettil malzeme olarak hesaplanmıştır Montaj hariçtir.



Gaziantep-2



Gaziantep-1



Gaziantep-3

SAYDAM MODEL

AK INOX



MALZEME LİSTESİ

Sıra	Malzeme Adı
1	Küpeşte Borusu-42,4x1,5mm
2	Küpeşte Mafsallı Takımı
3	Dikme Borusu-32x1,5mm
4	Boru Kapakları
5	Cam Tutucuları*
6	Rozet-67x12mm
7	Montaj Takımı

Not: Fiyatlarımız metrettil malzeme olarak hesaplanmıştır Montaj hariçtir.

* Fiyatlarımıza Cam dahil edilmemiştir.



MASA VE BROŞÜRLÜK MODELLERİ

AK INOX



Fiyatlar için sorunuz...

AK INOX

KAPI KOLLARI

Yeni
ecoline
serisi



Kapı Kolları
304 kalite paslanmaz çelik
malzemeden üretilmiştir.

320 kum
satineli polisaj



Takımda neler var?

- 2 Adet Kol
- 2 Adet Kol Rozeti
- 2 Adet Kilit Rozeti
- Montaj Vidaları



140 x 60 mm
Ürün Kodu 1700



140 x 60 mm
Ürün Kodu 1701



140 x 60 mm
Ürün Kodu 1702



140 x 60 mm
Ürün Kodu 1703

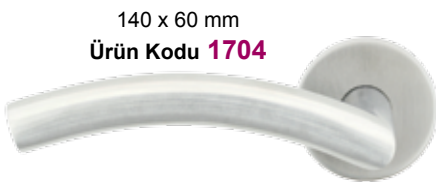

140 x 60 mm
Ürün Kodu 1704



140 x 60 mm
Ürün Kodu 1707



140 x 60 mm
Ürün Kodu 1712



140 x 60 mm
Ürün Kodu 1715



140 x 60 mm
Ürün Kodu 1714



140 x 60 mm
Ürün Kodu 1713



140 x 60 mm
Ürün Kodu 1716

"premium"
Satineli

Dolu
Malzeme



140 x 60 mm
Ürün Kodu 1708

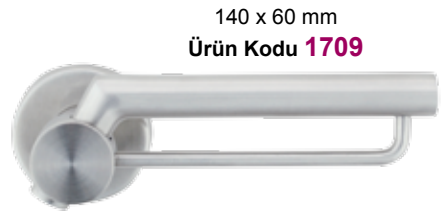

140 x 60 mm
Ürün Kodu 1709



140 x 60 mm
Ürün Kodu 1705

ROZETLER



26x65 mm
Ürün Kodu 1755-PZ



26x65 mm
Ürün Kodu 1755-BB



26x65 mm
Ürün Kodu 1755



ø 55 mm
Ürün Kodu 1750-WC



ø 55 mm
Ürün Kodu 1750-PZ











ø 55 mm
Ürün Kodu 1750-BB



ø 55 mm
Ürün Kodu 1750

DİZAYN ÇUBUKLAR

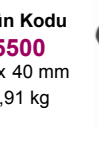
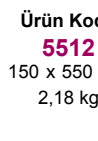
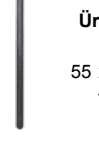
Boy: 800 mm, Malzeme ϕ 12 mm

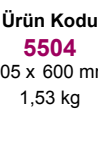
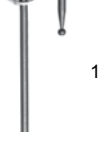
<p>Ürün Kodu 5501 40 x 600 mm 0,97kg</p> 	<p>Ürün Kodu 5521 110 x 430 mm 1,40 kg</p> 	<p>Ürün Kodu 5519 190 x 600 mm 2,14 kg</p> 	<p>Ürün Kodu 5513 150 x 550 mm 2,45 kg</p> 	<p>Ürün Kodu 5515 125 x 700 mm 2,56 kg</p> 	<p>Ürün Kodu 5508 130 x 540 mm 2,34 kg</p> 
<p>Ürün Kodu 5500 40 x 40 mm 0,91 kg</p> 	<p>Ürün Kodu 5512 150 x 550 mm 2,18 kg</p> 	<p>Ürün Kodu 5502 55 x 900 mm 1,87 kg</p> 	<p>Ürün Kodu 5504 105 x 600 mm 1,53 kg</p> 	<p>Ürün Kodu 5507 125 x 460 mm 2,17 kg</p> 	



DELİKLİ TRAVERSLER

Boy: 2000 mm, 14 Delik/Boy

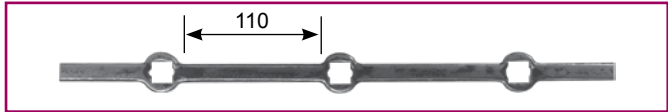

Ürün Kodu **11410-14** ■ 14 mm, Delikler □ 14 mm
Ürün Kodu **11410-20** ■ 20 mm, Delikler □ 20 mm

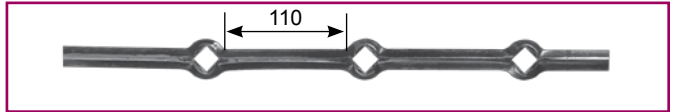

Ürün Kodu **11412-14** ◆ 14 mm, Delikler □ 14 mm
Ürün Kodu **11412-20** ◆ 20 mm, Delikler □ 20 mm

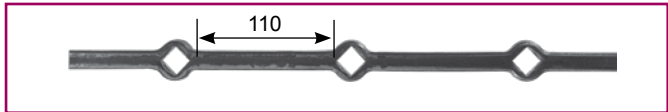















Ürün Kodu **11411-14** ■ 14 mm, Delikler □ 14 mm
Ürün Kodu **11411-20** ■ 20 mm, Delikler □ 20 mm



Ürün Kodu **11413-14** ● 14 mm, Delikler ○ 14 mm
Ürün Kodu **11413-20** ● 20 mm, Delikler ○ 20 mm

BABALAR (DİKMELER)

Boy: 1200 mm

<p>Ürün Kodu 8001 20 x 20 mm 3,79 kg</p> 	<p>Ürün Kodu 8003 20 x 20 mm köşe dövme 3,67 kg</p> 	<p>Ürün Kodu 8009 20 x 20 mm köşe dövme 3,79 kg</p> 	<p>Ürün Kodu 8017 25 x 25 mm köşe dövme 5,90 kg</p> 	<p>Ürün Kodu 8019 25 x 25 mm 5,90 kg</p> 	<p>Ürün Kodu 8020 ϕ 25 mm 4,60 kg</p> 	<p>Ürün Kodu 8021 25 x 25 mm 4,70 kg</p> 	<p>Ürün Kodu 8006 20 x 20 mm 4,07 kg</p> 	<p>Ürün Kodu 8008 20 x 20 mm 4,12 kg</p> 	<p>Ürün Kodu 8014 25 x 25 mm 4,90 kg</p> 	<p>Ürün Kodu 8015 25 x 25 mm 7,30 kg</p> 	<p>Ürün Kodu 8016 25 x 25 mm 6,70 kg</p> 	<p>Ürün Kodu 8018 25 x 25 mm 5,85 kg</p> 	<p>Yapraklı Üzüm 165 x 110 mm 1,08 kg Ürün Kodu 12038</p> 
---	--	--	--	---	--	---	---	---	---	---	---	---	---

AK FER

DÖVME ÇUBUKLAR

Ürün Kodu 5442 12x12 mm 1,10kg	Ürün Kodu 5401 12x12 mm 1,50kg	Ürün Kodu 5406 12x12 mm 1,80 kg	Ürün Kodu 5410 12x12 mm 1,55 kg	Ürün Kodu 5411 12x12 mm 1,95 kg	Ürün Kodu 5427 ø 12 mm 0,80 kg	Ürün Kodu 5417 ø 14 mm 1,25 kg	Ürün Kodu 5418 ø 14 mm 1,30 kg	Ürün Kodu 5415 ø 14 mm 1,20 kg	Ürün Kodu 5414 ø 14 mm 1,20 kg	Ürün Kodu 5412 12x12 mm 1,10 kg

Motif Detayı
Ø 30 mm



Motif Detayı
□ 30 mm



Boy: 900 mm

Ürün Kodu 5425 14x14 mm 1,80 kg	Ürün Kodu 5422 14x14 mm 1,65 kg	Ürün Kodu 5428 14x14 mm 1,80 kg	Ürün Kodu 5400 12x12 mm 1,30 kg	Ürün Kodu 5408 12x12 mm 1,70 kg	Ürün Kodu 5409 13 x13 mm 1,24 kg	Ürün Kodu 5405 12x12 mm 1,65 kg	Ürün Kodu 5438 12x12 mm 1,49 kg	Ürün Kodu 5439 12x12 mm 1,96 kg	Ürün Kodu 5419 12x12 mm 0,99 kg	Ürün Kodu 5420 12x12 mm 0,97 kg

Boy: 900 mm

BOYA VE DÜBELLER

AK EQUIP

ÜSTÜN ALMAN TEKNOLOJİSİ UZMANINDAN DIŞ ORTAMLARA DAYANIKLI EPOKSİ BOYA

WS-Plast Dickschicht M 4200
Astarsız Alüminyum, Bakır,
Prinç, Paslanmaz Çelik ve
Galvanizli Çelik yüzeylere uygulama!
**Ferforjede yıllar boyu
dekoratif koruma sağlar.**



Bu Üründe
Sertleştirici
Kullanılmaz



Paslanmaz Çelik Yüzey Temizleme ve Bakım Spreyi

Paslanmaz Çelik yüzeyleri temizleme ve koruma amaçlı. İç ve Dış mekânlarda kullanılabilir.

Sprey Kutu	Ürün Kodu
400 ml	25100

PATİNA UYGULAMALARINIZ İÇİN UZUN SÜRE SOLMAYAN ESKİTME BOYALAR



WS-Patina

İç ve Dış uygulamalara dayanıklı, Miktar: 250 ml.

Renk	Ürün Kodu
grün	25034
viole	25035
altın	25031
bakır	25032
gümüş	25033

WS-Zink-Farbe 108 (Soğuk Galvaniz Boya)



9,29
€/ Adet.

500 ml.

Kutu	Ürün Kodu
250 ml	25080
500 ml	25081
5 kg	25083

WS-Zink-Spray 108 (Galvaniz Spreyi)



4,78
€/ Adet.

400 ml.

Sprey Kutu	Ürün Kodu
400 ml	25070

YAPIŞTIRICILAR - DÜBELLER

AK EQUIP

MMK-P, 310 ml Polyuretan yapıştırıcı

- Hava nemi katkısıyla kurur
- Yüksek yapıştırma gücü
- Her türlü malzemeye uygun
- Kuruduktan sonra zımparalanıp boyanabilir.
- Renk: Krem Beyaz

Ürün Kodu **1712571**
12 Adet / Koli



m2, Ağır Yük Dübeli M2 DIN 125A'ya uygun

Ürün Kodu	Delik Çapı ø mm	Dübel Boyu mm	Efektif ankrāj derinliđi mm	Parça Kalınlıđı max / mm	Paket Miktarı	Karton Miktarı
3200885	8	85	50	15	100	300
3201009	10	95	58	15	100	300
3201011	10	110	58	30	50	150
3201211	12	110	68	15	50	150
3201212	12	125	68	30	50	150

MIT-P 350 ml



Styrene
Dikkat!
İçermez.

Ürün Kodu **1710028**
12 Adet / Koli



m2, Ağır Yük Dübeli, 316 Kalite Paslanmaz M2 DIN 125A'ya uygun

Ürün Kodu	Delik Çapı ø mm	Dübel Boyu mm	Efektif ankrāj derinliđi mm	Parça Kalınlıđı max / mm	Paket Miktarı	Karton Miktarı
3301009	10	95	58	15	100	300
3301211	12	110	68	15	50	150

MSH-Plus Universal Elek

ø13 x 100 mm



Ürün Kodu **1710142**
10 Adet / Paket

ø15 x 100 mm



Ürün Kodu **1710144**
10 Adet / Paket

En deęerli varlıklarımız olan çocuklarımızı korumak ve kazalara sebebiyet vermemek için korkuluk sistemlerinde kullanılan aralıkların, çocukların baş çevresi genişliğini geçmeyecek şekilde olması gerektiğini

BİLİYOR MUSUNUZ



Korkuluklarda kullanılan aralıkları 12 cm. den daha büyük yapmayınız...

Korkuluklarınızda, küpeşte olarak bildiğimiz el tutma yerlerini yaşlı ve çocuklarınızı düşünerek planlayınız, çünkü onların elleri narin ve küçüktür.

Küpeşterleri çabuk ve kolaylıkla tutmalarını sağlayınız.

Bu maksatla 51-60 mm gibi büyük çaplı borular yerine Avrupa'da yaygın olarak kullanılan 42,4 mm gibi daha dar çaplı borular tercih ediniz!..

Korkuluk yüksekliklerini insan boyunun yarısından daha yüksek planlayınız.



Korkulukların kullanıldığı yere göre 90-110 cm. yükseklikten daha az yapmayınız...

Almanya'nın sektöründe lider kuruluşumuz, örnek olarak Hessen Eyaleti İnşaat Yönetmeliğinde belirlenen standartları tavsiye etmektedir.

* Almanya Hessen Eyaleti İnşaat Yönetmeliği Paragraf 35 de, 12 metreye kadar korkuluk kullanılan yükseltiler için KORKULUK YÜKSEKLİKLERİ; işyerlerinde 100 cm., işyeri olmayan meskenlerde 90 cm. den, 12 metrenin üzerindeki yükseltiler için tüm meskenlerde 110 cm. den daha az olmaması gerektiği belirtilmiştir. Çocukların bulunma ihtimali olan meskenlerde KORKULUK ARA MESAFELERİNİN 12 cm. yi geçmemesi vurgulanmıştır.

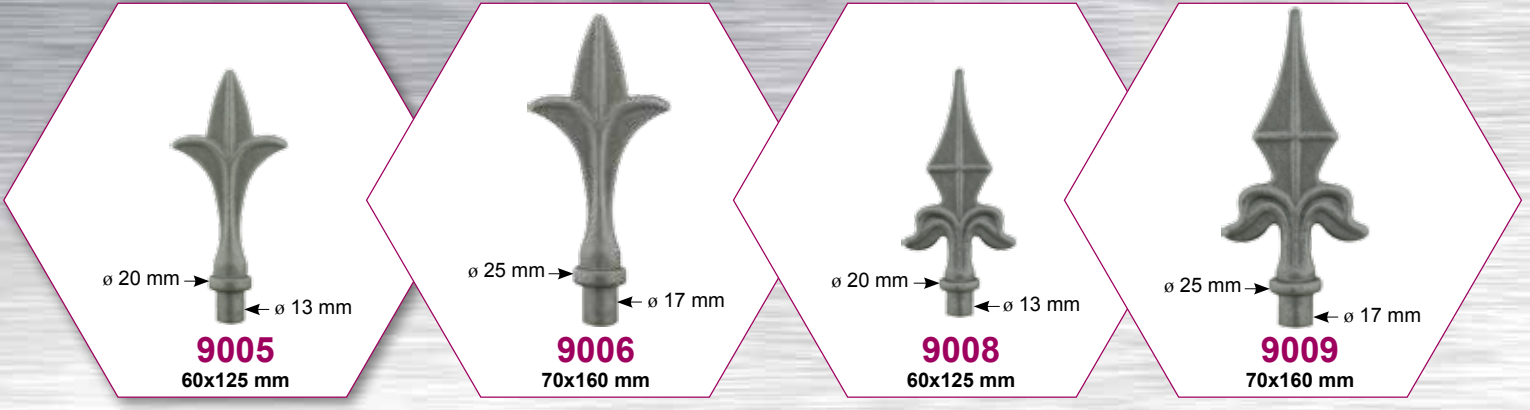

TİCARİ ŞARTLAR

1. Fiyatlar, KDV hariç, peşin ödemeli fabrika teslim fiyatlarıdır.
2. Dövizli fiyatlarda Garanti Bankası efektif satış kuru uygulanır.
3. Bonus ve Access kredi kartlarına taksit uygulaması yapılır.
4. Şirketimiz, fiyatlarda haber vermeksizin değişiklik yapma hakkına sahiptir.
5. Şirketimiz, baskı hataları ve yapılan uygulamalardan dolayı sorumlu tutulamaz.
6. Verilen ağırlık bilgileri yaklaşık değerler olup değişiklik gösterebilir.
7. Broşürde belirtilen fiyatlar 01.05.2009 - 30.05.2009 tarihleri arasında geçerlidir.

Akbaş

Korkuluk & Metal Ürünleri

AKBAŞ DIŞ TİCARET PAZARLAMA VE İNŞAAT LTD.ŞTİ.

Cevat Dünder Caddesi Nu: 148-150 Ostim / ANKARA

E-posta: bilgi@yapimetal.net

Telefon: (0312) 385 48 06(Pbx) Belgegeçer(faks): (0312) 385 42 16

www.yapimetal.net